

**OVIDIUS UNIVERSITY  
ANNALS  
ECONOMIC SCIENCES  
SERIES**

**Volume XV  
Issue 2**

**Year 2015**

ISSN-L 2393-3119  
ISSN 2393-3127



**OVIDIUS UNIVERSITY ANNALS**

**ECONOMIC SCIENCES SERIES**

**Volume XV**

**Issue 2**

**2015**



## EDITORIAL BOARD

### EDITOR in CHIEF:

- Elena Cerasela SPĂTARIU, “Ovidius” University of Constanța, Romania;

### SCIENTIFIC COMMITTEE:

- Paolo ANDREI, Università degli Studi di Parma, Italy;
- Stefano AZZALI, Università degli Studi di Parma, Italy;
- Gustavo BARRESI, Università degli Studi di Messina, Italy;
- Grigore BELOSTECINIC, Academy of Economic Studies of Moldova, Chișinău, Republic of Moldova;
- Rose-Marie BORGES, Université d'Auvergne, France;
- Ionel BOSTAN, “Ștefan cel Mare” University of Suceava, Romania;
- Ion BOTESCU, “Ovidius” University of Constanța, Romania;
- Nikoloz CHIKHLADZE, Kutaisi University of Georgia;
- Elena CONDREA, “Ovidius” University of Constanța, Romania;
- Suleyman DEGIRMEN, Mersin University, Turkey;
- Cosmin DOBRIN, Bucharest University of Economic Studies, Romania;
- Marina GEDEVANISHVILI, Caucasus International University, Georgia;
- Irina GOLUBKOVA, Odessa National Maritime University, Ukraine;
- Kai HAVEKOST, Bremerhaven University, Germany;
- Nicolae ISTUDOR, Bucharest University of Economic Studies, Romania;
- Zaichko Sergiy IVANOVICH, Odessa National Maritime University, Ukraine;
- Tamar KOBLIANIDZE, Caucasus International University, Georgia;
- Oksana LAVRIKOVA, Kherson State University, Ukraine;
- Víctor Raúl LÓPEZ RUIZ, University of Castilla-La Mancha, Spain;
- Roman MAMULADZE, Batumi State Maritime Academy, Georgia;
- Giorgi MATIASHVILI, Guram Tavartkiladze Teaching University, Georgia;
- Pasquale NOVAK, Università degli Studi di Messina, Italy;
- Snezhanka OVCHAVOVA, Varna Free University, Bulgaria;
- Alexis PAPATHANASSIS, Bremerhaven University, Germany;
- Domingo Nevado PEÑA, University of Castilla-La Mancha, Spain;
- Ion POPA, Bucharest University of Economic Studies, Romania;
- Veronica POPOVICI, “Ovidius” University of Constanța, Romania;
- Natalia REVUTSKA, Batumi State Maritime Academy, Georgia;
- Angela ROMAN, “Al.I. Cuza” University of Iași, Romania;
- Ahmet SENGONUL, Cumhuriyet Üniversitesi, Sivas, Turkey;
- Maia UKLEBA, Guram Tavartkiladze Teaching University, Georgia;
- Diane Paula Corina VANCEA, “Ovidius” University of Constanța, Romania;
- Simona UTUREANU, “Ovidius” University of Constanța, Romania;
- Răzvan ZAHARIA, Bucharest University of Economic Studies, Romania.

EDITORIAL COMMITTEE:

- Ionuț ANTOHI, “Ovidius” University of Constanța, Romania;
- Nicoleta ASALOȘ, “Ovidius” University of Constanța, Romania;
- Alexandra DĂNILĂ, “Ovidius” University of Constanța, Romania;
- Claudia DOBRE, “Ovidius” University of Constanța, Romania;
- Cristina DUHNEA, “Ovidius” University of Constanța, Romania;
- Cristina GEORGESCU, “Ovidius” University of Constanța, Romania;
- Gabriela GHEORGHIU, “Ovidius” University of Constanța, Romania;
- Silvia GHIȚĂ-MITRESCU, “Ovidius” University of Constanța, Romania;
- Maria Gabriela HORGA, “Ovidius” University of Constanța, Romania;
- Margareta ILIE, “Ovidius” University of Constanța, Romania;
- Victor JEFLEA, “Ovidius” University of Constanța, Romania;
- Cristina LAZĂR, “Ovidius” University of Constanța, Romania;
- Angela Eliza MICU, “Ovidius” University of Constanța, Romania;
- Adina MOISE TITEL, “Ovidius” University of Constanța, Romania;
- Andreea-Daniela MORARU, “Ovidius” University of Constanța, Romania;
- Irena MUNTEANU, “Ovidius” University of Constanța, Romania;
- Dorinela NANCU, “Ovidius” University of Constanța, Romania;
- Oana NIȚU, “Ovidius” University of Constanța, Romania;
- Cătălin PLOAE, “Ovidius” University of Constanța, Romania;
- Norina POPOVICI, “Ovidius” University of Constanța, Romania;
- Costin Octavian ȘORICI, “Ovidius” University of Constanța, Romania.

# TABLE OF CONTENTS

## Section I: International Affairs and European Integration

### *Subsection: International Affairs*

1.	Benchea Laura-Ramona	- Islamic Economics and Finance-a Revival after the Recent Global Financial Crisis?	2
2.	Botescu Ion	- The Crises under the Globalization of the World Economy	7
3.	Brasoveanu Florica, Anechitoae Constantin	- The Principle of Peaceful Settlement of International Disputes	13
4.	Buzarna-Tihenea (Galbeaza) Alina	- Several Aspects Regarding the Specialized Translation of Medical Texts. From Theory to Practice	17
5.	Căzănel Maria	- The Structure, Characters and Effects of Legal Rights Potestative	22
6.	Frecea Georgiana-Loredana	- CSR Crystallization in the Financial System: The World Bank Model	26
7.	Serbănel Cristiana - Ioana	- Romania's Electrical and Optical Equipment Industry Position on Global Value Chain in 2001-2011 periods	32
8.	Surugiu Farkas Ioana, Just Vanessa, Bartels Andreas	- Developing Sustainable Human Resource Management in a Shipping Company - A Study Case	37
9.	Toma Sorin-George, Marinescu Paul, Cosmin Stefan	- Towards a New World Economic Order	42

### *Subsection: European Integration*

1.	Enea Constanta, Enea Constantin	- Public Power - Economic Stake of Romanian Tourism	47
2.	Enea Constanta, Enea Constantin	- Romania's EU Advantages Integration	51
3.	Ghita Simona, Boboc Cristina, Manea Daniela	- Does Youth Migration for Education Have an Impact on Permanent Migration Decision? Case Study on Bessarabian Students in Romania	57
4.	Greco Mihaela, Titan Emilia	- Statistical-Based Insights in Migration Process	62

5.	Meiță Nela Loredana, Popescu Jenica	- Empirical Study on the Correlation Between the RDP and the Amount of Funds Allocated by the Tractors and Main Agricultural Machines in 2009 - 2013	66
6.	Schipor Constantin	- A Region of Welfare and a New Path for Europe	71

## Section II: Business Economy and Administration

### *Subsection: Economic and Social Studies*

1.	Brasoveanu Florica, Anechitoae Constantin	- The Principle of non-Interference in Internal Affairs	76
2.	Dobre Claudia	- The Structure-Performance Relationship in Romanian Banking System	80
3.	Florea Ilie Constantin	- IT&C - A Job-Creating Industry during Crisis	86
4.	Florea Ilie Constantin, Sommer Marc	- When Companies Become Too Socially Innovative to Fail	92
5.	Ghita Simona, Titan Emilia, Boboc Cristina	- Effects of the Global Financial Crisis on the Resources of Health System in Romania	98
6.	Gutu Ioana	- Negotiating T-TIP – Key Issues and Potential Implications for the Third Countries	104
7.	Gutu Ioana	- TTIP and the Implications for the Negotiation Process	110
8.	Juganaru Ion Danut, Juganaru Mariana	- The Romanian Chambers of Commerce, Representative Organizations of Entrepreneurs. The Example of Constanta Chamber of Commerce	115
9.	Lupsa-Tataru Dana Adriana, Lupsa-Tataru Florin Razvan	- The Evolution of Creativity Trend of Students of Transilvania University	121
10.	Mádr Michal	- Institutional Diversity in the Post-socialist Area during Crisis	125
11.	Mahfoudh Slim, Ben Amar Mohamed	- The Impact of Economic Policies on Economic Growth in a Group of Arabic Countries: Empirical Verification using Non-Stationary Panel Model	131
12.	Moise-Țiței Adina, Băcă Eleonora	- Adequate Income – A (Pre)Condition for Economic Justice	138



13.	Moise-Țiței Adina, Băcă Eleonora	- (Re)Mapping Geographies of Development-BRIC(S) Superpower Challengers?	142
14.	Moraru Camelia, Popovici Norina	- Estimated Reaction Function of Fiscal Policy in Romania	146
15.	Moțățăianu Alexandru, Vochin Oana Alexandra, Ciachir Liliana	- Globalization and Next Level for Virtual Teams	150
16.	Nancu Dorinela	- The Knowledge Assessment Methodology of Countries	156
17.	Nicodim Liliana, Tănase Gabriel-Iulian, Velica Marian	- Excellence in Objective Strategic Education in the Military University	160
18.	Osoianu Dragoș	- The African American Slavery - a Social Ecological Approach	166
19.	Stanciu Anca Cristina, Constandache Mihaela, Nenciu Daniela Simona	- Quality-Oriented Organizational Culture	171
20.	Stanciu Anca Cristina, Constandache Mihaela, Nenciu Daniela Simona	- Aspects Concerning Quality in Tourism	175
21.	Vasile Adrian	- The Loan in the Old Testament – Paradigm of the Contemporary Banking System	179
22.	Vasile Costin Mihai	- Eco-theology-Church's Solution on Humankind's Environmental Issues	184
23.	Vasile Costin Mihai	- The Secularization of the contemporary society and Holy Church's attitude toward this phenomenon	189
24.	Vitan Daniela	- Statistical Information Valencies Concerns the Economic Records at the University Level	193
25.	Voiculeț Alina, Belu Nicoleta	- Dimensions of World Food Issue in the Ecological Crisis	199

### ***Subsection: Marketing – Management***

1.	Anastase (Badulescu) Ileana, Grigoriu Cornel	- Innovative and Technological Transfer – a Requirement for Ensuring Economic Development	204
2.	Antohei Ionut, Moraru Andreea - Daniela	- The Approaches on Human Resources Management Practices within Romanian Companies - an Empirical Study	208

3.	Barbulescu Oana	- Clusters as a Tool for Development in the Wine Industry	213
4.	Bîrsan Alexandru, Shuleski Darko, Cristea Crina Veronica	- Bilbao Effect – Presentation, Examples, Perspectives	218
5.	Daneci Patrau Daniel, Arsenie Andreea	- Theoretical Approaches and Practical Aspects on the Financial Management of a Local Public Institution	223
6.	Dascălu Elena Doina, Nasta Laura, -	- Managerial Accountability – a Key Factor in the Implementation of Internal Control Systems	229
7.	Dragomir Cristina, Utureanu Simona	- Considerations on Ship Management and Current Changes in Maritime Transport	236
8.	Gheorghiu Gabriela	- The Need for Consumer Protection in the Consumerist Society	242
9.	Grigorescu Adriana, Condrea Elena, Bradley Christopher De Freitas	- Quality Management in Health Care System	246
10.	Ionita Roxana Mihaela	- Strategic Alternatives Adopted by Travel Agencies to Develop Tourism Services	252
11.	Iorgulescu Maria-Cristina	- A Look at Managers' Perception of the Innovation Activity in the Hotel Industry in Romania	256
12.	Iorgulescu Maria-Cristina	- The Quality of Hotel Services in Romania: an Application of the Servqual Model	261
13.	Kompalla Andreas, Kopia Jan	- Characteristics of Business Strategies and Management Systems within Automotive Industry	267
14.	Madar Anca, Neacșu Nicoleta Andreea	- Study regarding Consumer Protection and Satisfaction on Tourism Services market. Case study: Romania versus France	275
15.	Marinescu Paul, Toma George-Sorin, Ștefan Cosmin-Alexandru	- Leadership for the Virtual Age	283
16.	Mateescu Ruxandra Maria, Lange Steffen, Heinemann Bastian	- The Role of Process Interactions Management in Ensuring Business Sustainability	287
17.	Micu Angela-Eliza, Capățină Alexandru	- Managing Online Brand Identity: the Case of Two Pure Players	292
18.	Muhcina Silvia, Popovici Veronica	- Few Aspects Concerning the Marketing Particularities in Healthcare Services	300

19.	Munteanu Adina Roxana	-	The Dynamics of Organically Certified Operators in Romania Between 2012 and 2014	306
20.	Nancu Dorinela	-	Analysis of the Strategies Specific to Knowledge based Management	312
21.	Neacsu Nicoleta Andreea, Barbulescu Oana	-	Quality Strategies used by Market Leader in the Competitive Coffee	316
22.	Nicodim Liliana, Bucăța George, Muscalu Emanoil	-	Defining Influences Of Globalization On Education Management	322
23.	Nițu Oana, Nițu Claudiu Valentin, Tileagă Cosmin	-	Customer Relationship Management Using Information Technology	327
24.	Nițu Oana, Nițu Claudiu Valentin, Tileagă Cosmin	-	WEB 2.0 as a Customer Relationship Management Application - Specific Commercial Platform	332
25.	Păunescu Loredana Maria	-	Competitiveness Issue in Romania	337
26.	Podasca Raluca	-	The Role of the Forecast in the Company's Management	341
27.	Podasca Raluca	-	Cobb-Douglas Model Used in the Analysis of Enterprise's Performance	345
28.	Popovici Norina, Moraru Gheorghe, Moraru Camelia	-	Communication Style: Mirror of Individual's Behavior	349
29.	Serban Andrei Ionut	-	The Success Factors for Integrating Business Process Reengineering and Total Quality Management	354
30.	Teodorescu Ioana, Vasile Viorel	-	Landing Pages Features to Attract Customers	360
31.	Utureanu Simona, Dragomir Cristina	-	Ship Management Benchmarking	364

### ***Subsection: Finance and Accounting***

1.	Barna Flavia, Năchescu Miruna, Șeulean Victoria	-	Takaful Insurance and its Development Perspectives	370
2.	Bătrâncea Larissa	-	Ab initio: A Historical Perspective on Accounting	376
3.	Bobîțan Nicolae, Dumitrescu Diana	-	Interviewing as Investigative Technique Used by Forensic Accountants	380
4.	Briciu Sorin, Ofileanu Dimi	-	Possibilities of Using the Typical Survey in Audit	385

5.	Cărăușu Dumitru-Nicușor	-	Capital Market Efficiency in CEE Countries	392
6.	Căruntu Genu Alexandru, Ciurlău Loredana	-	Annual Financial Statements and the Financial Information Supply	398
7.	Chirculescu Maria Felicia, Bușan Gabriela	-	Various Approaches to Economic Development and Fiscal Policy for the European Union Member Countries	402
8.	Ciurlău Loredana, Căruntu Genu Alexandru	-	The Role of Foreign Banks in Ensure Performance the Romanian Banking System	406
9.	Dascălu Elena Doina, Nasta Laura, -	-	Efficiency of Tax Claims Collection through Foreclosure	410
10.	Dindiri Carmen Maria, Drăgan Cristian, Brabete Valeriu	-	Accountancy and Management of Human Resources Employed on Subsidized Places - Young Graduates -	417
11.	Drăgan Cristian, Mihai Magdalena, Dindiri Carmen Maria	-	Accounting and Tax Challenges Regarding the Joint Ventures	423
12.	Dreghiciu Andreea Elena	-	The Aspects of Revaluation of Tangible Assets	428
13.	Găban Lucian	-	Financing Policies in the Romanian SMEs	434
14.	Găban Lucian, Bechiș Liviu	-	Financial Autonomy in Local Romanian Administration	439
15.	Guni Claudia Nicoleta	-	The Relation Corporate Governance - Financial Communication Social - Responsibility to the Level of the Group of Companies	444
16.	Horká Eliška	-	The Monetary Transmission in the Selected CEE Countries	449
17.	Lăpăduși Mihaela Loredana	-	Indicators of Current Assets that Succinctly Express the Performance of their Use	453
18.	Măcsim Florin- Alexandru, Oprea Florin	-	Do Fiscal Constrains Actually Work in the EU?	458
19.	Manea Marinela - Daniela	-	Preoccupations and Tendencies within the Romanian Accounting Space Regarding the Capitalization of Intangible, Incorporate Assets owned by Companies in the International Context of Integrated Reporting	464
20.	Mihai Gabriel	-	The Procedure Of The Joint Stock Company's Capital Increase By Converting The Debts	470
21.	Mihai Luiza - Corina	-	The Economic Impact of Collective Dismissal Procedure Performed at the Level of Insolvent Employers	475

22.	Mirea Marioara, Munteanu Ionela	- "The Corporate Governance of Public Entities in Romania – Necessity or Formality?"	481
23.	Murgea Aurora	- January Effect and Market Conditions: a Case of Romania	488
24.	Murgea Aurora	- Holliday Effect in Contemporary Capital Markets	494
25.	Nancu Dumitru	- Methodology on the Classification of Guarantees, the Establishment, Regulation and use of Risk Provisions for S.M.E. Loan Guarantees	500
26.	Nancu Dumitru	- The impact of Implementing a New Rating System for the Framework Covenant on the Guarantee and Counter-Guarantee Coverage Level for SME Loans on the Access to Finance	505
27.	Negoescu Gheorghe, Florea Andrei-Mirel, Diaconu Aurora Aurelia	- BITCOIN Currency - Methods of Adapting to the Economic Crisis	511
28.	Nicolae Traian Cristin	- The Accounting Model for Calculating Performance of Entities and Share Based Payments	515
29.	Ofileanu Dimi	- Considerations Regarding Lean Approach Within Management Accounting	520
30.	Păunescu Loredana Maria	- Real Economic Growth for Romania – the Key Element Savior for a Long Period of Time?	525
31.	Pepi Mitica	- Regulatory Accounting When Securities Markets Are Stressed	529
32.	Pleşcău Ioana	- Defining and Measuring Bank's Equity Risk: Evidence from the Erste Bank Group Romania	534
33.	Popa Nicu, Popa Adriana Florina	- The Impact of Accounting and Fiscal Regulations on Corporate Income Tax Information Provided to Stakeholders	539
34.	Roman Angela, Rusu Valentina Diana	- Financing of the EU SMEs by the Capital Markets: An Overview	546
35.	Rus Mircea Iosif	- The Impact of Funding Research and Development Activities through the Core Programme	552
36.	Traistaru Diana Andreea	- Ethics and Morality in the Accounting Profession	556

37.	Trandafir Adina	-	The Influence of the Private Sector Financing on the Decision to Invest in Romania	560
38.	Vasilescu Laura, Tudor Sorin	-	External Financing for EU SMEs – Challenges, Measures and Trends	565
39.	Marian Alexandru	-	The Right to a Fair Trial among the Procedural Rights	570
40.	Marian Alexandru	-	The Independence of the Law Court	574

**Section I**  
**International Affairs and European Integration**

\*\*\*

**Subsection 1**  
**International Affairs**

# Islamic Economics and Finance – a Revival After the Recent Global Financial Crisis?

Laura-Ramona Benchea

*Bucharest University of Economic Studies, Faculty of International Business and Economics*

[laura.benchea@yahoo.com](mailto:laura.benchea@yahoo.com)

## Abstract

*The recent global financial crisis has brought into light some defaults and vulnerabilities of the conventional financial system that need to be thoroughly examined in order to prevent any further disorder for the world increasingly interconnected economies. Under these circumstances, the focus on the Islamic economics and finance and their underlying ideology has intensified as a consequence of the incremental need for alternative solutions to the traditional financial system which has already displayed its limits. This paper tries to explore the main characteristics of the Islamic economic and financial system and to examine to what extent its ideology may prevent further financial instabilities.*

**Key words:** financial crisis, Islam, Islamic economics and finance

**J.E.L.** classification : G01, G20, Z12

## 1. Introduction

As the serious repercussions of the global financial crisis that began in 2008 have subsided, economists and financial experts have intensified their efforts in the quest for answers, explanations and causes of what triggered this "black swan" [11] of the international financial system. Until now, trying to identify a solution to the crisis has proved to be an "impossible mission" as well as a topic of endless debate. Nevertheless, the diagnosis of the crisis' roots may represent the solution to proper treatment and appropriate prevention.

As a consequence of this disruptive phenomenon which exposed numerous flaws and vulnerabilities, the confidence in the traditional financial system has eroded

significantly. Under these circumstances, the Islamic economic model (Islamic economics and finance) came into light and the focus from many Muslim and non-Muslim scholars intensified as a result of the incremental need for alternative solutions to the conventional financial system which has already displayed its limitations.

The purpose of this paper is to find out whether the Islamic economic model has gained ground during recent years and if it is more resilient in times of crisis. In this respect, i firstly try to find out whether there really "exists" an Islamic economic science and i describe the main features of the Islamic economics and finance model; then, i analyze the main causes that triggered the recent global financial crisis. In the end i try to evaluate whether the Islamic financial sector is more robust than the conventional one in terms of being able to prevent or at least partially reduce the consequences of a financial crisis.

This paper is mainly conceptual and the methodological approach consists of a critical analysis of the relevant literature as well as on personal theoretical investigations.

The significance of this paper resides in its contribution to the literature by shedding new light on the revival of the Islamic economics and finance and their potential resilience when facing a crisis. The findings could of interest to Western and Muslim researchers, academicians and policy makers.

## 2. Islamic economics and finance - an overview

### 2.1 Historical and ideological background

The Islamic ideology in the economic sphere emerged at the beginning of the 20th century as part of an extensive campaign set out to preserve the cultural and religious



identity of the Muslim minority in India during the colonial period. Under these circumstances, some prominent scholars (Sayyid Al Mawdudi) tried to reassert their culture, especially to revive those traditions that once brought them "power, glory and prosperity". [6] Al Mawdudi preached that, in order to ensure their religious survival, Muslims had to apply the principles of Islam in every realm of activity, including the economic sphere, which had become increasingly important in everyday life. He also considered that economic change was essential to modernization and Muslims had to make economic adjustments in an Islamically acknowledged manner in order to preserve their religious identity. [6]

Further on, another prominent Muslim scholar, Said Qutb from Egypt, tried to integrate the Islamic orthopraxy (a correct behaviour rather than a doctrinal correctness) on a daily basis, Islamic economics emerging thus as one of the "fruits" of his intellectual efforts. [7] Although these scholars were not specialists in the economic field as we grasp the profession today, their contribution from a multi-disciplinary perspective (political, social, economical) was significant.

Islamic economics remained a part of the larger Islamic social and philosophical system until the middle of the 20th century, when different scholars began to thoroughly analyze the emerging discipline and to sketch their economic vision. Moreover, thousands of books and journal articles were written, numerous Islamic conferences were hosted in different countries all over the world and several research centers were settled in an attempt to delimit this specific discipline.

In essence, the main purpose of Islamic economics is to establish an economic order based on the principles set out by Sharia, the basic Islamic law. Sharia derived its precepts from the Quran (Islam's holy book) and the Hadith (the prophet Muhammad's teachings). It was designed to ensure two of the most important purposes: socio-economic justice and a state of all being for all God's creatures. [2] From this religious point of view, Chapra characterizes Islamic economics as "the branch of knowledge which helps realize human well-being through an allocation and distribution of scarce resources, that is in conformity with Islamic teachings without unduly curbing

individual freedom or creating continued macroeconomic and ecological imbalances".[2]

All these developments have contributed to the growing importance of Islamic economics as a potential science that has attracted a lot of attention from specialists in Muslim as well as non-Muslim countries.

## 2.2 Is Islamic economics a science?

Many Muslim as well as secular researchers have enthusiastically tried to establish and develop a doctrine and methodology of Islamic economics. Although some progress has been made, a full-fledged economic system with tenets and consistency has not been outlined yet. According to Hosseini [4], such a system is not possible for several reasons: firstly, there are different interpretations of the Koranic verses and the Hadith (the prophet Muhammad's teachings) and an agreement on the same principles is unlikely to happen. Secondly, various Muslims have divergent ideological convictions; for instance, while some Muslims find Islam closer to capitalism, there are others who consider it in harmony with socialism. Thirdly, in the absence of an individual with strong intellectual capabilities to lay down the fundamentals of an economic paradigm (like Smith, Marx, Keynes, Friedman) it is difficult to foresee the establishment of an Islamic economic paradigm accepted by Muslims of different ideological beliefs and of different sects.

There are many other Muslim economists who have different opinions. For example, M.A.Mannan considers that there exists a possibility for the Islamic economics to develop into a science. He asserts that Islam, through the Kuran and other religious sources is capable of giving responses to diverse economic issues, by developing a scientific methodology for Islamic economics, with several interrelated steps. [4]

The broad outline of the Islamic economics is determined by Islam's ethical philosophy of the "right": it first states what is "right" and then permits human beings to work out the most profitable way of action within some institutional constraints which must also be adapted to reflect Islamic principles and ideals. [9] The basics of this

philosophy consists of four ethical axioms:

-*Unity*-the economic activity of individuals must be directed by an ethical vision which should act as a "unifier of all aspects of human life into a consistent and mutually supportive totality"; [9]

-*Equilibrium* is required to promote social harmony and to maintain a balanced social structure;

-*Free will* provides liberty for economic and social activity, but it must be relied on justice;

-*Social responsibility*, especially a sensitivity towards the less privileged and those who live in extreme poverty.

The creation of a "unified" framework of ideas and actions is needed in order to build up social harmony and economic progress. [9] This could be an opportunity or a challenge to Muslim economies and societies and could help developing the Islamic economic doctrine and ideology.

According to Mahomedy [7], all these developments have contributed to the creation of the Islamic economics as a social science, a lot of emphasis being directed towards explaining how the ideal Islamic economic system should look like and how it would differ from the other economic systems, capitalism, respectively socialism. Some scholars (Nienhaus, 2000) consider that Islamic economics is beginning to distinguish itself as a science, but its progress is slow and discontinuous.[10]

There are other scholars who do not share the same optimism and enthusiasm regarding this doctrine. Among them, Kuran stands out when he firmly asserts that Islamic economics is an incoherent, incomplete, inconsistent and irrelevant doctrine. Moreover, he states that the main objective of the Islamic economics is not to solve important economic issues and to improve economic performance, but to prevent Muslims from being assimilated into the emerging global culture, advancing thus a kind of cultural protectionism. [6]

Although the objectives of the Islamic economics have hardly been achieved, from designing a coherent theoretical doctrine to the implementation of its recommendations into practice, the recent global financial crisis reasserted Islamic economics among the conventional economic systems.

### 2.3 What is Islamic finance?

Islamic finance, the flagship of Islamic economics, evolved in some Arab countries in the late 1970's, being fundamented on the Islamic principles and jurisprudence.[5]

This industry has rapidly expanded during the latest decades, mostly in Muslim countries, but in Western countries as well. Until the onset of the global financial crisis in 2008, Islamic banking industry was growing at a 15% average rate. [5] According to current data, the Islamic finance registers a 10-12% growth annually, its Sharia-compliant financial assets being estimated at approximately US\$2 trillion [13], comprising capital markets, bank and non-bank financial institutions and insurance.

In recent years, this industry has attracted some Western multinational financial institutions, such as Citigroup or HSBC, which started to offer Islamic financial products in some Arab countries (mainly in Bahrain and United Arab Emirates) and, to a lesser extent in some Western countries (notably, USA and UK). [1]

One of the basic principles of Islamic finance is the *prohibition of usury or interest (riba)*, as it is considered to fuel the exploitation of one individual by another. In addition, interest is forbidden as it implies a riskless economic venture and Islam encourages only the accumulation of wealth through personal effort, labor and capital investment, aspects that imply a certain degree of risk. Some researchers consider charging interest as being immoral as it "demeans and diminishes human personality". [12]

Then, how do Islamic banks make profit if they do not charge interest? In this respect, Islamic banking is based on another fundamental principle, that is the *profit and loss sharing (PLS paradigm)*. According to this principle, banks act as partners in businesses, meaning that they share the profit and as well as the losses with their partners.

Moreover, Islam prohibits risk, uncertainty and financial speculation. [12] Before signing a contract, it is mandatory that all parties involved have access to all the information required. Thus, transparency is advanced as a means of reducing uncertainty that may lead to inequity and injustice for one party because of lack of information. [12]

### **3. The financial "Tower of Babel" - brief considerations on the recent global financial crisis**

The global financial crisis that emerged in 2008 was triggered by the collapse of the U.S. subprime mortgage market. Prior to this event, there had been a series of aspects that culminated with an economic increase (an economic boom) that was considered to be the result of a synergy between finance, technology and global demand. [8] The upward movement consisted of the deregulation of financial markets, the reduction of the interest rates (the interest rate in the U.S. fell from 6,5% in 2001 to 1% in 2003) together with the introduction of flexible exchange rates and the development of financial innovations. All these exposed the financial institutions to high risks and eventually to the transmission of the crisis worldwide.

Under these circumstances, the metaphor "financial tower of Babel" was coined to stress the devastating consequences of an artificial construction, "a materialist ladder to heaven" [8] which collapsed when less expected. The association with the recent global financial crisis is clear and it suggests, in a hyperbolic manner, the serious damages that such a mechanism can create.

The "Financial tower of Babel" collapsed as it was built on too much debt and on symbolic assets, in the sense that they had speculative rather than real value. Moreover, the lack of confidence in the financial system led eventually to the outset of the global financial crisis.

In this context, Islamic finance gained significance as a consequence of the increased need for alternative solutions and improvements to the current state of art of the conventional financial sector that has already shown its limits and vulnerabilities.

### **4. Islamic economics and finance-a revival after the recent global financial crisis?**

Islamic economics and finance has gained importance during the latest decades as it has been perceived as a more equitable and efficient solution compared to the conventional financial system, which is based on interest. Relying on the two fundamental principles, that is the prohibition of interest

and profit and loss sharing, this model has gained worldwide confidence and credibility.

Moreover, the Islamic financial sector has grown rapidly during recent years. According to the Islamic Banking Database (2014) provided by the World Bank, the Islamic financial system is growing by 12-20% a year, comprising around 400 institutions in 58 countries. [14]

As the Islamic financial sector relies on the idea of justice, it introduced greater discipline by stimulating financial institutions to conduct in depth analysis and to monitor funds usage more effectively. Therefore, by controlling these major weaknesses that characterize the conventional system, the Islamic finance is capable to prevent or at least minimize the severity of a financial crisis. Moreover, there is a strong concern for ethics in Islamic financial system which has the role to protect the customer, the banks, and the society at large. [15]

A study carried out by the IMF in Pakistan [3] discovered that Islamic banks (in particular, their branches and subsidiaries) experienced less deposit withdrawals than conventional banks and some even faced an increase of deposits during the panic.

Other studies using data from 18 countries with substantial presence of Islamic banking, concluded that small Islamic banks are financially stronger and they lose strength as they grow bigger in size, which translates into challenges of credit risk management in larger Islamic banks.[3] Overall, the IMF report showed that Islamic banks were less prone to the risk of deposit withdrawals during the financial panic which enhanced Islamic banking system stability.

It cannot be firmly stated that the Islamic financial system can prevent a financial crisis, but the data show that this design is more resilient in times of crisis and relatively more stable compared to conventional financial institutions which were weakened by their own structural flaws as well as by the interdependence between them.

### **5. Conclusions**

Islamic economics and finance has gained significance after the recent global financial crisis, when scholars from Muslim and non-Muslim countries tried to find solutions to improve the conventional financial system

which has already displayed its limits.

The Islamic ideology in the economic sphere emerged at the beginning of the 20th century and it gained steadily significance as many specialists brought their contribution to designing an Islamic economic ideology. Many Muslim as well as secular scholars have tried to establish and develop a doctrine and methodology of Islamic economics. Although some progress has been made, a full-fledged economic system with tenets and consistency has not been outlined yet.

Moreover, although its objectives have hardly been achieved, from designing a coherent theoretical doctrine to the implementation of its recommendations into practice, the recent global financial crisis revived Islamic economic as a potential alternative to the conventional economic systems.

The recent global financial crisis outlined some vulnerabilities and defaults of the conventional financial system. All these issues need to be analyzed in a thoroughly and constructive manner in order to prevent the reoccurrence of a financial crisis. Under these circumstances, the focus on the Islamic financial system has intensified, as evidence has shown that the Islamic banking system proved to be more resilient and more stable during the global financial crisis.

In addition, it can be stated that the Islamic financial system is not an infallible system and it is difficult to presume that it could be accepted worldwide as a potential alternative to the traditional financial system. Nonetheless, it comprises some valuable principles, mechanisms and instruments that could be a great benefit to the conventional system. This could be a reason why some of the international financial specialists are open to the Islamic instruments, mainly after experiencing the severity of the recent financial crisis.

In conclusion, it can be stated that the Islamic financial system is well endowed with mechanisms and instruments capable to deliver noteworthy contributions to improve the practices and tools of the conventional financial system.

## 6. References

[1] Ahmed, A., "Global Financial Crisis: an Islamic Finance Perspective", *International*

*Journal of Islamic and Middle Eastern Finance and Management*, Vol.3, No.4, 2010, pp.306-320.

- [2] Chapra, U., "What is Islamic Economics?", *Islamic Development Bank*, 2001.
- [3] Farook, M., Zaheer, S., "Are Islamic Banks More Resilient During Financial Panics?", *International Monetary Fund Working Paper*, 2015, Internet Source: <https://www.imf.org/external/pubs/ft/wp/2015/wp1541.pdf>
- [4] Hosseini, H., "Islamic Economics—A New Economics or an Old Dogma?", *Forum for Social Economics*, Vol.16, No.2, 1986, pp.45-58.
- [5] Kumar, R., "Islamic Influence", *Strategies of Banks and Other Financial Institutions*, 2014, Chapter 10, pp.255-265.
- [6] Kuran, T., "The Genesis of Islamic Economics: a Chapter in the Politics of Muslim Identity", *Social Research*, Vol. 3, No. 4, 2009, pp.301-330.
- [7] Mahomed, C., "Islamic Economics: Still in Search of an Identity", *International Journal of Social Economics*, Vol.40, No.6, 2013, pp. 556-578.
- [8] Matthews, R., Tlemsani, I., "The Financial Tower of Babel: Roots of the Crisis", *International Journal of Islamic and Middle Eastern Finance*, Vol.3, No.4, 2010, pp.334-350.
- [9] Naqvi, H., "The Dimensions of an Islamic Economic Model", *Islamic Economic Studies*, Vol. 4, No.2, 1997, pp.1-23.
- [10] Sramek, O., "Islamic Economics: New Economic Paradigm, or Political Agenda?", *New Perspectives on Political Economy*, Vol.5, No.2, 2009, pp.137-167.
- [11] Taleb, N.N., *The Black Swan: The Impact of the Highly Improbable*, Curtea Veche Publishing, Bucharest, 2008.
- [12] Walton, M., "Can a Financial Crisis Occur Under the Rules of Islamic Finance?", 2011 Internet Source: [http://www.albany.edu/Walton\\_Thesis.pdf](http://www.albany.edu/Walton_Thesis.pdf)
- [13] World Bank, "Islamic Finance", 2015, Internet Source: <http://www.worldbank.org/en/topic/financialsector/brief/islamic-finance>
- [14] World Bank, "Islamic Banking Database", 2014, Internet Source: <http://econ.worldbank.org/WBSITE/EXTERNAL/EXTDEC/EXTGLOBALFINREPORT/0,,contentMDK:23492074~pagePK:64168182~piPK:64168060~theSitePK:8816097,00.html>
- [15] World Finance, "Could Islamic Banks Help Avoid Crisis?", 2012, Internet Source: <http://www.worldfinance.com/markets/islamic-finance/could-islamic-banks-help-avoid-crisis>

# The Crises Under The Globalization Of The World Economy

Ion Botescu  
Ovidius University of Constanza  
[ion\\_botescu@yahoo.com](mailto:ion_botescu@yahoo.com)

## Abstract

*The large number of crisis which have appeared after 1980, respectively during the accentuation of globalisation and the cyclicity with which these manifest themselves is not a novelty.*

*In the context of the globalisation of economic relationship, when through a large economic opening the countries become more and more dependent on exports to foreign partners, they become more vulnerable they become to crises which appear in the different areas of the globe.*

*Taking into account the very powerful impact which is generated by the apparition of a crisis, both governments and certain institutions should follow the evolution of the specialty economic indicators and implement the actions which aim to diminish the impact of crises.*

**Key words:** global crisis, contagiousness of crises, macroeconomic stability, sustainable development, trust

**J.E.L. classification:** F6

## 1. Introduction

The term globalisation was first used in the economic scientific literature at the half of last century.

Debates regarding globalisation have been intensified immediately after 1990. The continuity and irreversibility of the mechanism of globalisation, as well as the positive or negative impact which this phenomenon has generated in certain countries and on certain segments of the population have been subjected to debate by both politicians and researchers.

During the passing of time multiple schools of thoughts have discussed aspects induced by globalisation such as:

- Anthony Gidding has crystallised under a theoretical scheme a first period characterised by significant historical transformations, globalisation is viewed both as an opportunity and as a threat for our planet;
- Paul Hirst and Grahame Thomson are considered the pioneers of the sceptical school of thought regarding globalisation, the paper "Globalisation under the question mark" being a reference point in this sense;
- Thomas Friedman is remarked by the positive approach to globalisation, whose positive aspects are strongly shown through the critique to anti-globalists;
- Joseph Stiglitz possesses good knowledge of global financial institutions and through his work he has managed to identify the main necessary reforms which need to be put in practice in order to insure an equitable development of globalisation;
- Grzegorz W. Kolodko has been able through a critical approach to describe the role of the market and state in the period of the intensification of globalisation;
- Subcomandante Marcos is part of the sphere of radical researchers which approach globalisation from a Marxist point of view

In a time period of 20-30 years from the end of the second world war the economic crises which have impacted the global economy have been reduced in terms of number but their impact has been significant.

After the 80s, alongside the economic opening promoted by the majority of countries and alongside the growth of economic interdependencies at a planetary level there has been an increase in the

number of crises and their impact on the different national economies has been quite strong. We can state that a direct relationship exists between the intensification of globalisation and the negative effects generated by crises on the global economy.

At the same time as the crises which have developed in the last years of the last millennium (the Argentinian crisis, the Asian crisis, the Brazilian crisis) the contagiousness of these crises has also appeared. Multiple countries have noticed that their own economies have suffered as a consequence of various crises started in various areas of the planet.

Throughout the years much has been debated on the democracy export assured by the most powerful country in the world, the United States of America. We can accurately state which were the effects caused by the export of the financial crisis by the USA in 2007. Actually, due to the impact which it has had on the global economy, this crisis has been catalogued as a global financial crisis.

## 2. Global financial crisis: causes and effect

The global financial crisis which was started in 2007 in the USA was mainly caused by the triangle: the greed of bankers, the deregulation and the complicity of rating agencies.

The leaders of bankers through their so-called "performance bonuses" (sums with at least six zeroes) which they have cashed in has led to the increase in profitability of the institutions that they were leading.

In this situation many loans were awarded, the population having the possibility to acquire homes even if their income would not have normally allowed to obtain those credits. An upwards spiral of home prices started and eventually the real estate speculative bubble burst and this explains the banking crisis which was severe due to the stimulation of the growth home prices through the large number of credits. The intensification of the banking crisis was determined by the creation and sale of toxic products – guaranteed securities backed by overvalued mortgages– by banks. These products which have a high complexity level and low transparency level have proven extremely risky, their quotes have collapsed and this has led to the aggravation of the

banking crisis. We can state that through their attitude, the leaders of the banks have acted in their interest with a short term perspective. This behaviour has affected the interests of bank shareholders, clients and tax paying population on a medium and long term. The height of cynicism which was reached after the global financial crisis was the portrayed by the fact that a significant portion (billions of dollars) from the aid awarded to the banking system by the American administration was converted in bonuses.

It seems that the most efficient part from an indirect profit point of view is represented by the financing of election campaigns. The banks have identified these opportunities and have placed themselves on the front line of politicians' campaigns. Following the campaign, the politicians have repaid the bankers through favourable laws or renouncing on some laws that restrict their interests.

In general the banking system is well regulated, however in the same time a segment of this system is less regulated and this segment regards the mortgages which have determined many people to acquire high risk derivative mortgage products.

Last but not least, we need to state the contribution that the most prestigious rating agencies in the world have had in the formation of the banking system crisis. The industry competition as well as the wish to cash in large amounts of money for their services have determined the rating agencies to give very good investment ratings to a series of products which have proven to be toxic.[1] The mortgages on which the respective banking products were based were over evaluated and this raises at least at a moral level a series of questions regarding the ratings of the rating agencies.

*Table 1. Annual GDP Growth Rates (%)*

	2008	2009	2010	2011	2012	2013	2014
World level	1,49	-2,01	4,09	2,88	2,18	2,28	2,48
Developed countries	0,07	-3,66	2,63	1,50	1,07	1,24	1,69
Developing countries	5,14	2,88	7,74	5,78	4,66	4,62	4,33
Transition countries	5,36	-6,55	4,74	4,60	3,27	2,26	0,83

Source: [www.unctad.org](http://www.unctad.org)

On a global level the effects of the global financial crisis were evident in 2009 when

the global GDP fell by 2.01% in comparison to the previous year. A significant decrease of the GDP in 2009 was recorded by the developing countries (3.66%) which initiated the crisis and transition countries (6.55%) respectively those countries with a smaller consolidated market economy and implicitly with a higher vulnerability to economic turbulences. Overall, developing countries have seen a positive economic growth (2.88%) in 2009 and this positive growth has been maintained until present times.

Figure 1. The comparative evolution of the global exports and GDP (annual average rate, %)

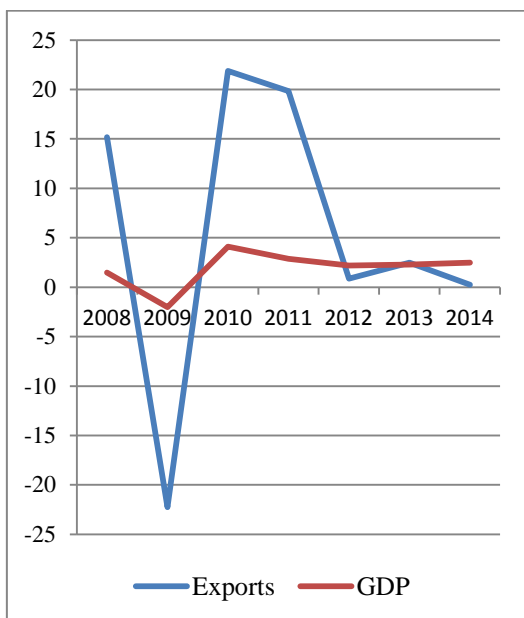

Source: www.unctad.org

From the first figure we can observe that between 2008 and 2014 the evolution of the annual exports and GDP growth rates (%) was developed in the same sense, with the mention that in the first part of the interval there was a very high discrepancy between the two indicators, difference which was dramatically reduced in the second part of the time interval.

During the crisis the most affected countries were those with economies based on manufactured goods (with China's exception). Their production capacities being affected by the reduction of orders made by importing countries. Also in the category of countries which were strongly affected by the crisis we can include the countries from Central and Eastern Europe, and eventually

those from Latin America which were commercially dependant of the developed countries of Western Europe and the USA.

The least affected countries by the crisis were those of Eastern Asia which were more careful, having learned the lessons from the crisis of 1997 and the raw material exporting transition countries from Africa and Latin America. The volume and prices of goods exported by the mentioned countries has increased in the last 5-6 years as a result of orders made to sustain the economic growth of China. The reduction of the price of oil has determined a decrease of the revenues of exporting developing countries in 2014 and 2015.

The production sites, equipment, workers, etc are the same as those during the period before the crisis as well as during the crisis. The element which deteriorated during the crisis was trust. The lack of trust determined a substantial increase of the difference between the interest rate of interbanking loans and the state loans interest rates in 2007 and 2008. The necessity of rebuilding trust was the main justification of politicians to provide financial aid to banks. At least under this aspect a lesson was learned from the experience of the great crisis of 1929-1933. Lasting damaging effects generated by the 1929-1933 crisis were largely due to a significant number of bank bankruptcies. The massive financial packages granted by governments to rescue the banking system played a positive role in reducing the suffering caused by the crisis triggered in 2007 in the US. Although the financial rescue packages come from the budgets of the various countries, supported by the population paying taxes, their grant was not followed by a series of coherent conditions imposed to the banking system that caused this catastrophe. A fundamental principle of capitalism was also violated, under which uncompetitive firms that make losses are excluded from the economic system.

### 3. Romania's economy in the period preceding the crisis

Joining NATO in 2004 and the EU in 2007, were significant moments in our country's economic development.

The GDP, the main indicator that quantifies the economic development of a

country, has experienced steady growth between 2000-2008, growth which we can characterize as mainly being unhealthy. Both exports and imports in the mentioned interval increased, with the mention that the average annual growth rate of imports was higher than the average annual growth rate in exports, which resulted in a significant trade deficit for Romania. Moreover the trade deficit weight in Romania's GDP recorded annual rates was of over 10%, a situation which could lead the country to enter default. Fortunately Romania has avoided this difficulty due to major currency income derived mainly from three sources:

- Foreign direct investment as a result of the beginning of the privatization of large state firms, many of them in the utilities, which allowed them to have a monopoly; we consider in this regard gas distribution, electricity distribution, Petrom, the Romanian Commercial Bank etc.;
- Financial flows sent to our country by Romanians who work abroad were close to 10 billion dollars in 2008;
- Foreign currency loans granted by Romanian banks (mostly foreign-owned) to legal and natural persons in our country; were granted as loans mainly in foreign currencies as costs for local currency loans were significantly higher.

It was attempted to support the economic development to some extent by stimulating consumption through credit, which partly failed because many of the products purchased by Romanians were imported, causing as mentioned above a dangerous increase of the trade deficit Romania.

Romania's economic growth was due mainly to the speculative operations which were determined by the artificial increase in the prices of land and homes.

Illustrative is the contradictory value of indicators recorded that have characterized the Romanian economy in 2008. We consider in this regard on the one hand the 8.5% GDP increase from the previous year, the 13,4 billion dollar sin flows of foreign direct investment, 9.2 billion dollars remittances entered Romania, the 13.4% share of public debt to GDP and on the second hand the 7.8% annual inflation rate, 18.4 billion

dollars foreign trade deficit in goods and services, the 5.4% share of budget deficit to GDP.

All the presented elements allow us to state that Romania has recorded an unsustainable economic growth in the pre-crisis period, which revealed major shortcomings of the Romanian economy during the crisis.

The situation was further complicated by the reckless behavior of government policy makers during the election year of 2008. The Support of unsubstantiated expenses when the first signs of the global crisis had emerged in the US in 2007 worsened the economic situation of Romania complex year 2009.

One example can be enlightening in this respect. Although the Prime Minister said in 2008 that the economy had generated expenses that our country could not afford, consuming including 2.2 billion euros from the privatization of BCR. Originally, the 2.2 billion euros National Development Fund was established which aimed to support the construction of motorways or cash expenses. It opted not to develop infrastructure but to support spending, with the idea that the government would later succeed by issuing bonds to get money for completing the original amount of the National Development Fund, however this has not succeeded yet.

#### **4. Romania between the turbulences of the crisis and macroeconomic stability**

Unfortunately, Romania was not ready to face the challenges of the financial crisis, with the leading economic indicators deteriorating seriously in 2009. In this context, Romania's GDP fell from the previous year by 7.1% and the budget deficit GDP was 7.3%. Inflows in Romania of foreign direct investment and remittances in 2009 represented only 31% and 52% compared to the levels attained in 2008. The fact that 2009 was also an election year (presidential elections) resulted in postponing the measures necessary for economic correction. Once the electoral process was completed a series of tough measures were approved and implemented, which aimed to reduce the number of employees in the budget: 25% reduction of salaries in the public sector; VAT increased from 19% to



24%, etc. Romania contracted from the IMF in May 2009, a loan of euro 12,9 billion dollars with all the restrictions that such an approach entails.

From the experience of other countries it results that the global public debt in the first three years following the crisis, increased on average by 86%. [2] In Romania, according to information provided by the central bank, public debt rose to 11.9 billion euros 2009 to 23.5 billion dollars in 2012. Public debt rose by 97.4% between 2009 and 2012, slightly higher than the average value recorded internationally which demonstrates once more the difficulties through which Romania went through.

Figure 2. The evolution of Romania's GDP

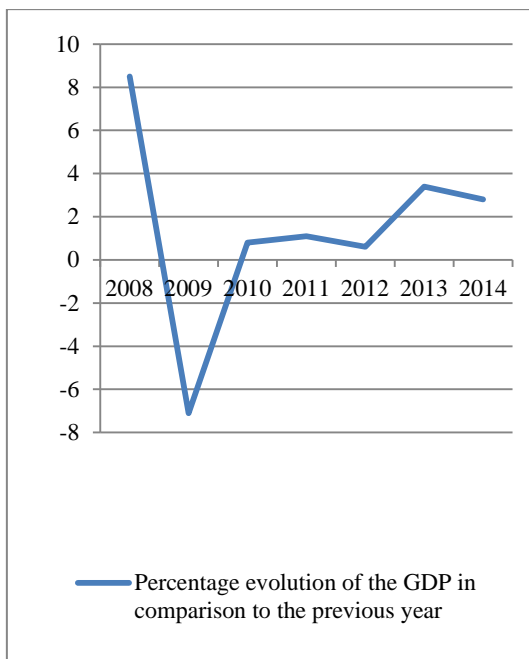

Source: <http://ec.europa.eu/eurostat>

Through the dynamic of the GDP it results that Romania has recorded a positive evolution in the last years.

Figure 3. The evolution of the budgetary deficit of Romania (GDP weight)

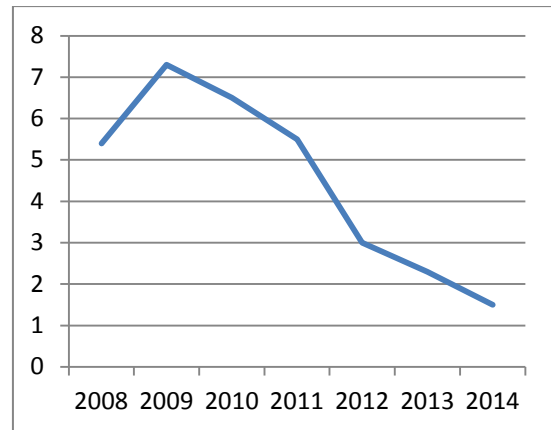

Source: [www.insse.ro](http://www.insse.ro)

The reduced sustainable values of the weight of the budget deficit to GDP recorded in the years 2013 and 2014 compared with the corresponding 2009 and 2010, make Romania fall within the limits of this indicator set by the EU rather low.

Figure 4. Romania – the weight of the public debt in the GDP(%)

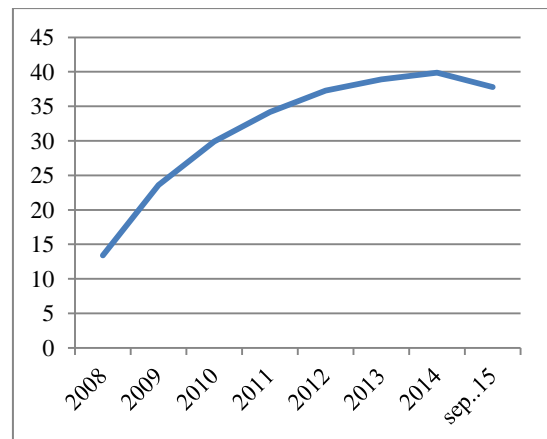

Source:

<http://www.mfinante.ro/rapoarteMFP.html>

Regarding the government debt in the GDP, Romania recorded a significant increase in this indicator in the period that followed the crisis struck. However, two positive remarks are necessary: the downward trend in this indicator in 2015 and that its value is under 40%, Romania being in an extremely favorable position compared with both the EU limits and especially with the actual values recorded by EU advanced economies countries.

The favorable picture of macroeconomic stability related to Romania in 2014, must be completed by an annual inflation rate of

almost 1.1% and that by that fact that 1990 was the first year where there was a slight excedent in the foreign trade balance in goods and services.

Basically the Romania of 2014 fulfils the criteria necessary for joining the Euro. Romania is characterized by a solid macroeconomic stability which could be a factor of great importance in achieving sustainable development. Populist measures such as wage increases, special pensions or in some cases taxes reductions do nothing but increase the budget deficit and public debt with negative repercussions in the medium and long term both in terms of Romania's economic development as and regards the living standards of citizens in our country.

## 5. Conclusions

Experience has demonstrated the appearance and manifestation of cyclical global economic crises. There is no secret to a man of good faith that the key to prolonging economic boom periods and reducing the time interval in which there is a crisis is investment.

Sustainable economic development is recommended to be made, including in the case of Romania, through investments and development primarily with the aim to increase the exports of manufactured goods with high added value.

Someone said that a smart man learns from experience, and a wise man learns from others.

Unfortunately whenever a crisis erupted, in the preceeding period the governments of several countries have demonstrated neither intelligence nor wisdom. Touched by the syndrome "this time will be different" the concerned governments did not take the best measures for mitigating the effects of the crisis since it started.[3] Experience has shown that even the most advanced financial systems can be seriously affected by the desire to obtain huge profits in the short term and the less-inspired maneuvers the decisions makers.

## 6. References

- [1] Stiglitz J., *În cădere liberă*, Ed. Publica, București, 2010, p. 48
- [2] Reinhart C M., Rogoff K., *De data asta e*

- altfel*, Ed. Publica, 2012, p.233
- [3] Reinhart C M., Rogoff K., *De data asta e altfel*, Ed. Publica, 2012, p.432
- [4] Anghel L., Dinu M., *Globalizarea afacerilor*, Ed. Tritonic, București, 2014
- [5] Jones A., *Globalizarea*, Ed. C.A.Publishing, Cluj Napoca, 2011
- [6] Kolodko W.G., *Încotro se îndreaptă lumea*, Ed. Polirom, Iași, 2015
- [7] [www.unctad.org](http://www.unctad.org)
- [8] <http://ec.europa.eu/eurostat>
- [9] <http://www.mfinante.ro/rapoarteMFP.html>
- [10] [www.insse.ro](http://www.insse.ro)
- [11] <http://www.zf.ro/opinii/vine-o-noua-criza-economica-si-suntem-nepregatiti-14662250>
- [12] <http://www.zf.ro/eveniment/cum-s-au-evaporat-2-2-miliarde-de-euro-din-privatizarea-bcr-bani-cu-care-trebuia-construite-autostrazile-9479102>
- [13] <http://www.capital.ro/acordurile-romaniei-cu-fmi-de-la-ceausescu-si-pana-in-prezent-184243.html>
- [14] <http://www.bnr.ro/Publicatii-4.aspx>

# The Principle of Peaceful Settlement of International Disputes

Florica Braşoveanu

*The Faculty of Law and Administrative Sciences, Ovidius University of Constanta*  
[floriordache@yahoo.com](mailto:floriordache@yahoo.com)

Constantin Anechitoae

*The Faculty of Law and Administrative Sciences, Ovidius University of Constanta*  
[anechitoae@yahoo.com](mailto:anechitoae@yahoo.com)

## Abstract

*In relation to the principle of peaceful settlement of international disputes UN Charter (Art. 2 pt. 3) states that "All members shall settle their international disputes by peaceful means so that international peace and security, and justice, are not endangered".*

*The Charter also indicates, in art. 33 pt. 1, the regulatory means: negotiation, inquiry, mediation, conciliation, arbitration, judicial settlement, regional agencies or arrangements, other peaceful means as chosen by parties [1].*

*The content of the principle expresses so, on the one hand, the general obligation of peaceful settlement, on the other hand, the right of free choice of means of settlement.*

**Key words:** peace, international disputes.

**J.E.L. classification:** K33

## 1. Introduction

Since ancient times it appeared that the only alternative to the policy of force, aggression and war is the peaceful settlement of all disputes.

Peace as a distinct institution of public international law is a statement of fact and law as a result of the agreement between the warring parties on the cessation of the war and the signing (ratification) of a peace treaty [2].

Peace is a state of spirit present among members of the international community, characterized by refraining from the use of force or threat of use of force to resolve international disputes and by promoting

international cooperation in order to solve social problems.

As legal situation, this institution is found present in international relations following the institutionalization of global political-legal system of peace, security and cooperation BD, universal policy formalized by the UN Charter and other international documents and instruments.

Peace is an essential condition of life; on its restoration, maintainance and strength, depends the normal development of nations achieve to progress and civilisation, goals of all mankind.

Peace is the subject of creation, the fundamental premise of the great discoveries of human genius, the guarantee of their use towards the advancement of all peoples.

Only peace can provide man with the natural climate man needs to the affirmation, peace and security on our planet [3].

## 2. Peace – a fundamental right

The concept of peace understood as being of key importance in art. 39 of the UN Charter, is not defined in the wording of the UN Charter or in any other international document. In common sense, peace means the absence of war, as it was understood in classical international law, which was made up of two main parts:

- the law of peace;
- the law of war (jus bellum ac pacis).

But the concept of "peace", as it is understood by the Security Council, is much broader than in its classic sense.

The concept of peace in the sense of the UN Charter includes not only the absence of war between states, but other factors relating to the economic, ecological and humanitarian dimensions of international relations [4].

An analysis based only on the provisions of art. 39 of the UN Charter, accomplished over time, would be purely retrospective and descriptive.

The need to identify certain objective criteria for defining the scope of peace or threat to peace becomes evident [5].

Most commonly, it is considered that the determinations in art. 39 are conclusive and at the absolute discretion of the Security Council. To clarify the content of the concept of peace and respectively threat to peace, various advanced criteria have been suggested.

Often, attempts to impose formal definitions of these concepts were made. So sometimes a threat to peace is defined as "a situation in which an organ competent to impose sanctions, declares the existence of a threat of peace.

This definition puts the focus on the discretionary powers of the Security Council and not the actual content of the peace, respectively the nature of the threat.

They also advanced the idea that the Council was assigned to be the only body to adopt political decisions as regards both the decision-making process, but also in the substance of the decision.

### **2.1. Threats to peace**

So far there is no uniform definition or an objective understanding of the threat to peace, and for its content, states are expected to have an obligation not to cause threats to peace. In this respect, the threat to peace does not have the status of legal prohibition.

This statement is based on the following argument: if the threat to peace would be a legal prohibition, then the Security Council wouldn't have to justify its determination based on art. 39, by reference to facts or objectives concrete circumstances that threaten the peace.

Council would not be bound by any criteria to characterize certain situations as threats to peace [6].

Another argument in this regard is that concerning the threat to peace any such general concept can not be deducted.

The existence of this must be decided by the Security Council in each specific situation. Thus, the consequences of this determining are assumed basically to be

converging with the usual expectations of states.

A threat to peace can be identified by the behavior of certain actors and / or a process / of a situation. The threat source has been identified in the Council's practice in several ways.

It was interpreted as a resident in the action of a state or a government or regime, or certain processes or situations (humanitarian emergency, terrorism, etc.). The Conduct of a state, a government has sometimes been seen as a source of threat to peace

### **2.2. Prohibitions of use of threats to peace**

The prohibition of the use of force or threat of force is in direct relationship with the duty of all States to use peaceful means to settle disputes between them [7].

Under the UN Charter, the parties to any dispute, the continuance of which may threaten the maintenance of international peace and security they seek, above all, to settle it by negotiation, inquiry, mediation, conciliation, arbitration, judicial settlement, by use to regional agencies or arrangements, or other peaceful means of their own choice (art. 33).

Thus the charter establishes a general obligation of all states to use only peaceful means for the settlement of disputes between them

In light of the Charter, the obligation is placed in direct connection with the demands of maintaining peace, international security and justice

Historical experience, particularly the events of this century, the current developments of the international situation shows that recourse to peaceful means, negotiations and talks, the political solution is the only possible rational logic governing any dispute [8].

Peaceful settlement is a fundamental component of security, of building international relations based on exclusion force on mutual understanding and trust ; recourse to peaceful means constitutes a basic principle of international relations, as it provides the necessary criteria and for states - in good faith and in a spirit of cooperation - to reach a rapid and equitable solution based

on international law; settlement through peaceful means is a method as it allows states to decide how they will solve disputes between them.

It should be noted that if a solution is not reached by using one of the peaceful means set out in the Charter of Nations United, the parties to the dispute have the duty to continue to seek a mutually acceptable way to regulate the conflict peacefully.

The obligation to resort to peaceful means implies at the same time that States Parties to a dispute and other countries refrain from any action that might aggravate the situation so as to endanger the maintenance of international peace and security and in this way, hindering settlement of the question through peaceful means.

### **3. The principle of non intervention**

The principle that domestic situations are generally not of concern internationally continues to be considered

According to some authors, the reference made in the UN Charter to "international peace" is considering restricting Council jurisdiction to intervene in domestic situations, such as civil war, despite the fact that such actions would constitute breaches of the peace. Internal wars and changes of governments would thus be situations that can not be regulated by the Security Council [9].

The argument presented is formally correct. However, some domestic situation may have international implications. An obvious example of such involvement may be given to situations where internal conflicts have consequences beyond national frontiers, such as the flow of refugees, environmental pollution etc

This idea, that the non-intervention principle in the internal affairs of a state is a *jus cogens* rule was expressed by another author [10].

The respective author points out that the UN Charter regulated this principle, ensuring that nothing "can not authorize the United Nations to intervene in matters which are essentially of the domestic jurisdiction of a State".

Thus, by the Charter, non intervention has become one of the seven basic principles of

the United Nations and thus the entire international community.

Moreover, the internal competences of a state where one can not intervene from the outside was extended from those who are "only in the domestic jurisdiction" to those that are "essentially within the domestic jurisdiction" of a state.

Principle of non-intervention is a consequence of the principle of state sovereignty. Each state is sovereign and equal in terms of rights in relation to the other

Being sovereign a state can't be subjected to foreign intervention in their internal affairs, unless he expresses his will accordingly .

Therefore, any intervention, economic, political, military or otherwise, is not permissible without prior agreement explicitly expressed under international law.

Armed intervention or other forms of intervention involving use of force are prohibited under the principle of non-intervention .

### **4. The principle of peaceful settlement of international disputes**

On this principle the distinction between the dispute and the situation has some relevance, as used by the Charter (Art. 34).

The dispute is a disagreement between two or more states have already made claims (their positions are clearly demarcated), while the situation is a circumstance actually occurred between two or more states, producing friction between them and which may evolve or not into a dispute [11].

This principle was determined by the specificity of the international society, who felt the need to find means of peaceful settlement of international disputes [12]. Thus, Article 33 of the UN Charter provided, in case of disputes between States, means to address them.

Peaceful means that international disputes can be resolved through are

➤ *Diplomatic means:*

- ✓ direct negotiation
- ✓ good offices
- ✓ mediation
- ✓ international investigation;
- ✓ international reconciliation

➤ *Intergovernmental organisations:*

- ✓ Universal organization such as the UN, especially its organs: the General Assembly, Secretary General, Security Council etc
- ✓ regional organizations.
- *Judicial means*
  - ✓ international arbitration;
  - ✓ permanent international justice

Considering the exceptional importance of using only peaceful means for the settlement of disputes between states, particular interest was manifested and there still is in finding appropriate ways to earmark this obligation in legal instruments to develop the Charter and other international documents.

In this respect, the assumption of a commitment by all states to use consistently and exclusively peaceful means to solve any dispute and, primarily, to negotiations and direct consultations between stakeholders is compulsory.

Assuming such a commitment must take a solemn form, with legal force. Undoubtedly, in this way, recourse to peaceful means would turn from a general wish of the peoples in an everyday, permanent way of settlement of any dispute between two states or generally in international relations.

## 5. Conclusions

The literature noted that the only prerequisite condition for regaining confidence between parties to the dispute is the use of peaceful means to settle the dispute, because - both during the efforts made to resolve the dispute, and afterwards, when it was already resolved - the two sides revert gradually to normal relations in direct contacts in various fields, and those elements of tension and suspicion that have survived on during the dispute are eliminated. It is understandable that only if the two sides have the political will and act firmly to remove the causes of conflict and its consequences, seeking those appropriate solutions through concerted efforts trust is reborn and the

suspicion is removed. It is the climate of peace and a germinating condition that stimulates relations based on it.

## 6. References

- [1] Floroiu, M. *Law and International Relations*, Editura Didactică și Pedagogică, R.A., București, 2013, p. 32.
- [2] Rusu, P.I. *Usual, diplomatic and international law terminology dictionary*, Cartea Universitară, București, 2004, p. 155.
- [3] Mazilu, D. *Law of Peace. Treaty*. All Beck, București, 1998, p. 15.
- [4] Tomescu, M. *The threat to peace in the context of contemporary society*. In: Tomescu, M. and Dragne L., *International law between science and policy. Dumitru Mazilu In Honorem*. Universul Juridic, București, 2011, pp. 314-335.
- [5] Orkhelashvili, A., *Legal Aspects of Global and Regional International Security*, 2000, p. 21.
- [6] *Curtea Internațională de Justiție, Namibia Case, advisori opinion*, ICJ Reports 1971, paragraful 16 și urm.
- [7] Mazilu, D. *Law of Peace. Treaty*. All Beck, București, 1998, p. 163-169.
- [8] Treverton G. F., *Nuclear Weapons and the „Gray area”*, în F.A., nr. 5, 1979, p. 1077 și urm.; Thomas L. Neff and Henry D. Jacoby, *Nonproliferation Strategy in a Changing Nuclear Fuel Market*, în F.A., nr.5, 1979, p. 1142-1143.
- [9] O'Connell, *Regulating the Use of Force in the 21<sup>st</sup> Century: Continuing Importance of Autonomy*, în: "Columbia Journal of Transnațional Law", nr. 36/ 1997, p. 481.
- [10] Jianming S., *The Non-Intervention Principle and Humanita Intervendons Under International Law*, în "International Legal Theory", vol. 7(1)/spring 2001, p. 7 și urm.
- [11] Anechitoae C. *International Law Elements*. București, Bren, 2010, pp. 81-82; Anechitoae C. *Geopolitics of maritime systems*. București, Ed. Militară & Top Form, p. 16; Anechitoae C. *Introduction to international maritime law*. București, Bren, 2011, p. 23.
- [12] Floriu, M. *Concepts of public international law* Editura Didactică și Pedagogică, R.A., București, 2013, p. 44.

## Several Aspects Regarding the Specialized Translation of Medical Texts. From Theory to Practice

Alina Buzarna-Tihenea (Galbeaza)  
Ovidius University of Constanta, Faculty of Letters  
[Alina\\_buzarna84@yahoo.com](mailto:Alina_buzarna84@yahoo.com)

### Abstract

*Translation represents an extremely useful and necessary means of communication. This paper starts by analyzing several types and definitions of the term "translation", followed by a brief presentation of the evolution of medical language. Moreover, it deals with the similarities and difference between English and Romanian specialized terminology and discusses several difficulties encountered while translating medical texts. In this regard, it is noteworthy that the translator of specialized texts should be a professional, since any type of wrong translation or any mistake or misinterpretation for that matter could lead to serious consequences.*

**Key words:** translation, medical texts, terminology, English, translator

**J.E.L. classification:** I 19

### 1. Introduction

Types and definitions of translation. Different scholars have divided translations into various types, according to different criteria, at different levels of generality or specificity. Roman Jakobson (1992) explained in his article "On Linguistic Aspects of Translation" that translation is of three types. The first type presented by the author is intralingual translation, which he also calls rewording. Intralingual translation is "an interpretation of verbal signs by means of other signs of the same language" [1]. The second type of translation, and the one this paper deals with, is interlingual translation, also called translation proper, which represents "an interpretation of verbal signs by means of some other language" [2]. Intersemiotic translation, also called

transmutation, is the last type of translation presented by R. Jakobson and it interprets "verbal signs by means of signs of nonverbal sign system" [3].

Juliane House (1997) classifies translation as either overt or covert [4]. In overt translation, the target text appears like a translation and it is obvious, as the target text does not match the original. Within a covert translation the target text would rejoice the status of the source text in the target language culture, for example in scientific, economic terms, in tourist brochures, or in the case of journalistic discourse. Peter Newmark (1981) differentiates between semantic translation and communicative translation [5]. In the first case, the focus lies on the aesthetic value – the beautiful and natural sound of the source language text, compensating and compromising on meaning. It is more flexible, more creative, and more imaginative than the second type. On the other hand, communicative translation is more concerned with the overall meaning of the text.

Christiane Nord (1997) distinguishes between documentary translation and instrumental translation [6]. Documentary translation, as the author observes, is the method and type of translation whose aim is to report on the communication given in the source text. It is in fact a reproduction of the source text with an emphasis on formal correspondence without assorting the target text into the target situation. The other type of translation, the instrumental translation, aims at producing a target text that functions independently from the source text. Lawrence Venutti (2004), who differentiates between two concepts, domestication, and foreignisation [7], brings another approach. In domestication, the translator's purpose is to achieve a fluent, transparent style in the target language. On the other hand, foreignisation represents a type of resistant translation, in which the translator's purpose

is not to achieve the fluency that would hide the text as a translation.

## 2. Evolution of medical terminology

Henrik R. Wolff (2004) argues that there is "no recognized discipline called medical linguistics", but that "the language of medicine offers intriguing challenges both to medical historians and to linguists" [8]. Wolff explains that the oldest written sources of Western medicine belong to Hippocrates, from the fifth and the fourth century before our era, and that after the Roman conquest, the Romans imported Greek medicine, later Latinized it, and then translated it into Latin, since they had no such medical tradition. The author also explains that national medical languages appeared with time, such as medical English, French, German, Italian etc. Wolff (2004) writes that medical language followed two patterns: the Germanic and the Romance one [9]. The Germanic pattern often preserved the Latin endings, whereas in the Romance languages medical language was naturalized.

Nowadays though, most major medical journal use English, as this language became the first choice for international conferences. Wolff (2004) believes that "we have entered the era of medical English, which resembles the era of medical Latin in that, once again, medical doctors have chosen a single language for international communication" [10]. Juhani Norri (1992) provides a comprehensive analysis of medical terminology by naming several semantic patterns [11], such as metaphor (for instance, the use of the term fire to designate an inflammatory condition of the skin, cloud for a film covering the eye, or corn, to designate a round swelling), metonymy (for example, bruise, to describe a breaking), specialization of meaning (an example in this regard is fit from Old English, meaning hardship, but used to signify attacks of illness), suffixation and prefixation, imports and compounds and phrases (such as brainwashing and nose bleeding).

As Louis Deroy (1956) stated, "there has never existed a totally isolated language, without any borrowings" [12]. Society permanently transforms and renews itself in an amazing rhythm, and the changes are to be found in every field, emerging through terms

that reflect novelty, most of them borrowed from other languages, such as English, French, German or Spanish.

## 3. Similarities and differences between English and Romanian medical terminology

"Every profession has its jargon, a specialized language that allows for quick, efficient communication between members of the same profession while minimizing the potential for misunderstandings, (...) including identifying insiders and excluding outsiders" [13]. This is precisely why Dyche and Tom Suttie from Des Moines University, Iowa, offer a comprehensive course in medical terminology. This course discusses two major categories of medical terms: descriptive terms – related to shape, color, size, or function, and eponyms, which put a name to medical terms. Eponyms have been used to "honor those who first discovered or described an anatomical structure or diagnosed a disease or first developed a medical instrument or procedure" [14].

Medical terminology technically represents words and phrases designated to describe medication, procedures, anatomical structures, instruments, and many other techniques or tools used in medicine. It actually is the language of medicine and it has a rich and long history. Most of the medical terms derive from Latin or Greek. Nevertheless, since every language domain has a set of rules and/or exceptions, it is not impossible to break through. Even the most apparently complex medical terms are nothing but combinations of smaller subsets of word divisions. There are indeed hundreds of medical roots, prefixes, and suffixes to be learned, but once a translator learns these word divisions, he or she would be able to combine them to form thousands of medical terms. These word divisions may include one or more of the following: root words, prefixes, suffixes, and combining vowels. Combining vowels are used sometimes to create a word flow. Take for example, Pneumonoultramicroscopicsilicovolcanokoniosis, which is, according to Oxford Dictionaries, coined as the longest medical word in a major dictionary, has 45 letters, and it is defined as: "a factitious word alleged



to mean 'a lung disease caused by the inhalation of very fine silica dust, causing inflammation in the lungs' [15]. According to Chris Cole (1989), the word is referred to as "P45" [16]. Nevertheless, this is not the longest English word.

Dyche's course in medical terminology also talks about this division process, offering several examples [17]. Following this terminology course's pattern, Romanian terms will also be introduced, to observe the differences or the resemblance between English and Romanian terminology.

ENGLISH	ROMÂNĂ
<b>Myocarditis</b>	<b>Miocardită</b>
<u>Prefix</u>	<u>Prefix</u>
myo = muscle	mio = mușchi
<u>Root</u>	<u>Rădăcină</u>
card = heart	card = inimă
<u>Suffix</u>	<u>Suffix</u>
itis = inflammation	ită = inflamație
<b>Prefix change:</b>	<b>Schimbare pref.:</b>
myocarditis = muscle layer of heart inflamed	Miocardită = inflamarea mușchiului inimii
Pericarditis = outer layer of heart inflamed	Pericardită = inflamarea stratului extern al inimii
endocarditis = inner layer of heart inflamed	Endocardită = inflamarea internă a inimii
<b>Suffix change:</b>	<b>Schimbare suf.:</b>
cardiologist = a physician specializing in the heart	cardiolog = medic specializat în afecțiuni ale inimii
cardiomyopathy = damage to heart muscle layer	cardiomiopatie = afecțiuni ale mușchiului inimii
Cardiomegaly = enlargement of the heart	cardiomegalie = mărirea inimii

As observed, due to the common ground regarding Latin and Greek origins, English and Romanian medical terminology is very similar. This similarity comes not from the concept denoted by a certain word, but from the prefixes and suffixes, and also mostly from the Latin root that the word has. For example, the suffixes below look very much alike, and the examples are very similar, even though the English word "pain" does not resemble in form to its Romanian counterpart, "durere".

-algia, -algnesia	-algie, -algezie
-------------------	------------------

= pain	= durere
e.g. myalgia = muscle pain; analgesia = relief from pain	ex.: mialgie = durere musculară; analgezie = scădere / pierdere a sensibilității la durere

#### 4. Case study

As with any specific field, medical translation requires training and extensive knowledge of the subject matter besides linguistic skills. The analyzed corpus was made available by the National Institute of Neurological Disorders and Stroke ("Neurological Diagnostic Test and Procedures"). In this regard, we used several translation methods so as the target text would look neat and would respect the format, the syntax, the terminology, and all the other aspects of the source text. During the translation of the text, it has been observed that the main difficulties, as discussed, are specialized terms, since these could have more than one meaning, and proper research has to be conducted, since there is room neither for mistakes, nor for ambiguities. This particular text was not one of the most difficult, since it was an informative text and many of the specialized terms were included in the explanation of each concept or apparatus. Therefore, even if medical terminology presents difficulties in terms of ambiguity, this was not the case. Nevertheless, the main difficulty was whether acronyms should be translated or not. They were rearranged or translated, since the acronyms were accompanied by their extended form; if the Romanian version of the extended form was different, leaving the acronym as in the source text would have confused the readers, especially if they would not have any type of knowledge regarding English language, not to mention medical terminology. By researching several medical analyses' lists offered by different outpatient medical laboratories, it has been noticed that the main problem with medical acronyms or abbreviations is that most Romanian medical services use English abbreviations together with the Romanian translation. It has been judged as a problem in this context, because, as it has been mentioned before, using an extended Romanian form together with an acronym that does not resemble it might be

confusing for people without both medical background and linguistic skills regarding English language.

Judging by the "explanatory tone" of the text, it can be assumed that it is intended mostly for the public, an aspect that made the process of translating easier. For the most part of the translation, dictionaries and various online sources had to be consulted, as well as the terminology issues presented in the previous sections of this paper, since it provides the translator with many hints concerning what a certain prefix or suffix means and what it refers to. The last difficult aspect of this particular translation was maintaining the source text flow and its purpose, an aspect that appears in the case of translators at the beginning of their careers, with little experience in translating, not to mention medical texts, which by no means are easy to work with. Precisely this was the case regarding the translation below. Taking into account the fact that, as mentioned, several dictionaries and sources had to be consulted, immediately following the translation is a glossary, written both in English and in Romanian, which contains most of the medical terms encountered in the source text and translated in Romanian. The importance of a glossary is unimaginable, especially when the text to be translated is part of a specialized field and contains many terms that are ambiguous on their own.

Another effective method to acquire knowledge regarding terminology is represented by research and terminological files. The problem with equivalent terms or phrases is that if the translator does not have much knowledge regarding translation, he or she might "insert" new terms to a certain language, only because of not knowing that that specific language does not have an equivalent phrase or term. For example: a *avea pitici pe creier* in Romanian means to be crazy. Nevertheless, saying in English to have dwarfs on/in the brain would not only be incorrect, but it would sound weird and unfamiliar. This research reveals how many connections and concepts surround a simple term, as well as why experience, research, and sources are very important when it comes to translation.

## 5. Conclusion

The paper has briefly discussed the difficulties encountered while translating medical texts. In this respect, a very effective method to acquire knowledge regarding terminology is represented by research and terminological files. Along with the ontological and conceptual map of terms, these terminological files represent effective translation tools, revealing the connections and concepts which surround a simple term. It is also noteworthy that experience, research, and sources are also important key factors when it comes to specialized translation.

## 6. References

- [1] Jakobson, R., "On Linguistic Aspects of Translation", *Theories of Translation. An Anthology of Essays from Dryden to Derrida*. Ed. Rainer Schulte and John Biguenet., The University of Chicago Press, Chicago, 1992, p. 145
- [2] Idem, p. 148
- [3] Idem, p. 151
- [4] House, J. A., *Model for Translation Quality Assessment*. Tübingen, Gunter Narr, 1997, eBook, p. 32
- [5] Newmark, P., *Approaches to Translation*, Pergamon Press, Oxford, 1981, p. 78
- [6] Nord, C., *Text Analysis in Translation: Theory, Methodology and Didactic Application of a Model for Translation-Oriented Text Analysis*, Rodopi, Amsterdam, 1997, p. 47.
- [7] Venutti, L. *Rethinking Translation: Discourse, Subjectivity, Ideology*, Routledge, London and New York, 1992, p. 13.
- [8] Wolff, H. R., "The language of medicine." *Journal of the Royal Society of Medicine*. 97 (2004): 187-8. Web. 02 Jun. 2013.<http://www.ncbi.nlm.nih.gov/pmc/articles/PMC1079361/>
- [9] Idem
- [10] Idem
- [11] Norri, J., *Names of Sicknesses in English, 1400-1550: An Exploration of the Lexical Field*, Suomalainen Tiedeakatemia, Helsinki, 1992, pp. 224-8.
- [12] Derooy, L., *L'emprunt Linguistique*, Société d'édition Les Belles Lettres, Paris, 1956, p.5.
- [13] Dyche, W. J., and Suttie, T., "Medical Terminology Course." *Medical Terms*, Des Moines University. Web. 01 Jun 2013. <<http://www.dmu.edu/medterms/>>.
- [14] Idem

- [15]Oxford Dictionary
- [16]Cole, C. "The Biggest Hoax." *Word Ways: The Journal of Recreational Linguistics*. (1989), Web. 10 Jun. 2013. <[https://www.meducation.net/community\\_notes/11276-Silicosis](https://www.meducation.net/community_notes/11276-Silicosis)>.
- [17]Dyche, W. J., and Suttie, T. op. cit.

## The Structure, Characters and Effects of Legal Rights Potestative

Maria Căzănel  
Ovidius University of Constanța  
Faculty of Law and Administrative Sciences  
[maria.cazanel@gmail.com](mailto:maria.cazanel@gmail.com)

### Abstract

*Potestative rights constitute a heterogeneous category, as some are patrimonial property rights and others are not. Some are related to certain non-ancillary rights in rem, others are related to claim rights.*

*The legal mechanism of the exception for the non-performance contract resembles that of potestative duties, given that they are exercised by the unilateral will of the holder as interference in the sphere of legal interests of the passive subject. However, the two legal institutions are set apart by a number of fundamental differences. The exception for the non-performance contract is a sanction, available only to the contracting party which, simply by invoking the exception, can block the appeal made in court by the contractual partner (which has not executed its obligation), due to the fact that it forces the party, invoking the exception, to follow the provisions of the contract.*

**Key words:** contract, potestative rights, joinder, exception of a non-performed contract.

**J.E.L. classification:** K

### 1. Introduction

The notion of rights potestative means the separate category of subjective rights, characterized by the fact that the holder is awarded the power to intervene in the existing legal situation (to make adjustments or to terminate them), or create new legal situations, through a private and unilateral activity.[1]

The doctrine has grouped these rights in a separate category and has given them the name: potestative rights, thus showing that

they "signify the power they give the tenant, a natural or a legal person, to influence the unilateral and discretionary pre-existing legal situation, modifying it, extinguishing it, or creating a new legal situation".[2] One can infer from this definition the fact that the potestative right is characterized, on the one hand, by the originality of its object and, on the other hand, by the state of dependence of the legal situation to the unilateral manifestation of the will of the holder of that right. Therefore, the potestative right expresses a favourable position, an advantage, enjoyed by its holder, and, therefore, its effectiveness is much higher than the non-ancillary rights in rem and the claim rights.

The notion of "potestativity" may be associated with that of the "potestative condition" or the "potestative right".[3] Moreover, the greatest contribution of this theory is manifested in conventional potestative rights, namely the rights stipulated by the parties in their agreement, whenever the question of distinguishing between the two concepts arises.[4]

The common element is the idea of "power" or domination of one of the Parties belonging to the legal relationship. The potestative condition is made permissible by the legal procedure, with the exception of the purely potestative condition undertaken by the party which bounds itself, affecting the liability by making it invalid and synonymous with arbitrariness, thus evincing no intention to be bound.

The potestative right is not characterized by arbitrariness, but by a special connection established between the holder of the potestative right and the addressee, which is "bound" to bear the interference of the holder in its legal sphere, through a unilateral act of will on the part of the latter. The addressee of the right is not required to give, do or not do something, only to suffer the consequences

of the actions of the holder of the potestative right. It follows, therefore, that the potestative right is distinct from the potestative condition provided by the Civil Code.

In the context of the current literature of the legal field [5], "potestativity" evokes direct relationship established between a person (called potentior) and a legal situation involving another's interests, a situation to which this person may intervene by its unilateral will.[6]

## **2. The structure, characters and effects of legal rights potestative**

Based on these characteristics, the literature indicated that the potestative right has a unique structure and characteristics, irreducible to the traditional classifications of subjective civil rights.[7] The structure of the potestative right has two elements that distinguish it from the other types of subjective civil rights:

- the subject of the potestative right is a legal situation, not a good or a service, as is the case of non-ancillary rights in rem or claim rights;

- both the active and the passive parties are determined, but the latter was in a special position of subordination compared to the holder of the right.

Compared with non-ancillary rights in rem and claim rights, the potestative right differs in as follows:

- it does not confer prerogatives over a good, but it does so over the legal situation, unlike non-ancillary rights in rem. However, through the potestative right, the holder may accede to the acquisition of a non-ancillary right in rem (for example, in the case of a recipient of a unilateral promise of sale);

- Contrary to the right of claim, potestative right does not give its holder the power to demand that a passive subject (the debtor) follow a certain manner of conduct: to give, to do or not to do something;

- the potestative right involves at least two determined individuals: potentior and the passive subject, which will bear the consequences of exercising this right, as is the case of the claim right. But, to a creditor, the holder of the potestative right is in a highly advantageous position, since he/she can exercise its right without any

contribution from the passive party;

- the potestative right, as secondary or intermediate right, has the disadvantage that it gives no immediate prerogative over an object or a person.

A closer analysis of the structure of the potestative right has revealed that it can not be included in any of the traditional classifications of subjective civil rights due to their legal character. The potestative right may focus on a patrimonial legal scenario or non-patrimonial and, according to it, it can acquire a patrimonial or non-patrimonial nature.

Similarly, the potestative right nears absolute rights, to the extent that the potestative right holder may follow a line of conduct, without the involvement of another person, that has direct and immediate power over a legal situation.

As with absolute rights, any individual, with the exception of the holder, has a general duty to do nothing negative, likely to prejudice that right. Such a task falls upon the passive party, as well as upon third parties. Therefore, to the extent that it, alone or with others, acts to defraud the interests of potentior and hinder the use of the right, it will be considered liable to him under tort liability, irrespective of whether the potestative right is exercised under a contract or outside one.[8]

On the other hand, the potestative right lies near the relative claim rights, since it involves, besides its holder, at least one determined subject (the recipient of the potestative right). Hence a certain "relativity" of the potestative right, which is given by the relativity of the legal situation in itself, which is the subject of the potestative right, unlike the claim right, whose relativity is understood to mean that this right corresponds to an actual obligation, which devolves upon the debtor (passive subject) to force him/her to give, to do or not do something.

Regarding the effects of the potestative right, legal literature showed that the holder of the potestative right, first of all seeks its own interest in establishing, maintaining or transforming the legal situation in which they find themselves. Therefore, potestative right has to be examined through the perspective of the potentior and his interest to preserve or change the position they occupy in a legal

situation, which would only be possible, however, whilst working, at the same time, in the legal sphere and other issues of law involved. [9]

Thus, the following consequences emerge:

- both holder of potestative right and the passive subject, as well as the people determined or determinable, find themselves in a dynamic legal situation;

- the active subject has direct and immediate power to change the legal position by its will unilaterally, thus acting both within their own legal sphere and within that of the other party, lawfully involved in the legal situation;

- the subject can not oppose legally, through a notice of appeal, the legal interference, of the other party, in its own sphere.

One also needs to take into consideration the constitutive, modifying or terminating effects as well as the declarative effects of the potestative right, meaning that, it can also focus on the recreation of a legal situation (the right of the third-party beneficiary to accept or deny their rights, received from the promisor, as an effect of the stipulation for another).[10]

Legal literature has shown that change, termination or recreation of the underlying legal position, through the exercise of a potestative right, may produce legal effects for the future and strengthen or refute existing legal effects (the right of a successor to accept or renounce an open succession for which he/she has a vocation or calling). The potestative rights are manifested in unilateral legal acts.[11]

This analysis has shown that, although, as a whole, potestative rights make up a special category of subjective civil rights, they do not form a homogeneous and well defined category (as is the case with the claim rights) because of the unique physiognomy each of them has, determined, inter alia, by the particular features of the object (a legal situation that may be present, future, possible, uncertain, patrimonial, non-patrimonial), by the specific manner in which it is exercised (which can be a physical act, a unilateral act, an appeal in court etc.).

However, they may be included in the same category due to their common traits: they focus on a legal situation; it is exercised

through the unilateral will of the holder; their application is an interference in the sphere of the legal interests of another person; passive subject can not preclude the exercise of the potestative rights by its holder, which means that, from this point of view, he must submit to the active subject.[12]

### 3. Conclusions

Given the specific characters, structure, and manner of exercising and effects of the potestative rights, one might conclude that the exception of a non-performance contract may be included in this category of subjective civil rights. However, it is safe to say that *exceptio non adimpleti contractus* can not be regarded as a potestative right, because it has a strong comminatory trait; it is an important means of coercion on the other contracting party because, as far as the latter asks the other party to respect the provisions of the contract, in order to have them met, he/she will be compelled to immediately meet the provisions of the contract. Moreover, if the case of the exception of a non-performance contract, the parties are not in a relationship of subordination, of the passive subject to the contracting party, invoking the exception, but in a position of legal equality. That being said, the exception of a non-performance contract can be seen as a means of protection and a corrective, aimed at ensuring the balance between the Contracting Parties.

For these reasons, we consider that the basis of the exception of a non-performance contract is the legal connection between the mutual obligations of the parties which arise directly or indirectly from their contractual will, based upon the underlying principles of good faith and fairness.

### 4. References

- [1] Reghini, I., "Considerații privind drepturile potestative", *Pandectele române nr.4/2003*, pp.236; Chirică, D., "Promisiunea unilaterală de a vinde și de a cumpăra", *Revista de drept comercial nr.9/1999*, pp.45; "Pactul de preferință", *Revista de drept comercial nr.11/1999*, pp.31; "Denunțarea unilaterală a promisiunii sinalagmatică de vânzare-cumpărare", *Dreptul nr.3/2001*, pp.28; "Promisiunea sinalagmatică de vânzare-

- cumpărare ca formă autonomă de contract", *Studia Universitatis Babeş-Bolyai nr.2/2000*; Deleanu, I., "Problema constituționalității prevederilor art.494 alin.ultim, teza a doua din Codul civil român", *Dreptul nr.6/2002*, pp.23; Stoica, V., "Drepturile patrimoniale atipice", *Dreptul nr.3/2003*, pp.55-58; Stoica, V., *Drept civil. Drepturile reale principale*", vol.I, ed.Humanitas, București, 2004, pp.133-134.
- [2] Deleanu, I., "*Părțile și terții. Relativitatea și opozabilitatea efectelor juridice*", ed.Rosetti, București, 2002, pp.206.
- [3] Valory, St., "*La potestativité dans les relations contractuelles*", Presses Universitaires D' Aix-Marseille, 1999, pp.24 în Avram, M., "*Actul unilateral în dreptul privat*", ed.Hamangiu, București, 2006, pp.162.
- [4] Avram, M., op.cit., pp.162-163; Mihai, G., Trandafirescu, B.C., "*Dreptul comerțului internațional*", ed. Muntenia, Constanța, 2008, pp.150 .
- [5] Especially French legal literature : Najjar, I., "*Le droit d'option. Contribution à l'étude du droit potestatif et de l'acte unilateral*", L.G.D.J., Paris, 1967; Valory, St., op.cit. în Stoica, V., op.cit., pp.133-134.
- [6] Hage-Chahine, F., "Essai d'une nouvelle classification des droits privés", *Rev.trim.dr.civ.*, 1982, pp.737 în Reghini, I., op.cit., pp.236.
- [7] Avram, M., op.cit., pp.152.
- [8] Valory, St., op.cit., pp.46 în Avram, M., op.cit., pp.152.
- [9] Stoica, V., op.cit., vol.I, pp.135. While admitting that there is a specific legal bond between the potential and the passive party, the author judiciously points out that the potestative right is primarily reported on the legal scenario and only secondarily on the passive party. There is a special bond between *potentior* and all those whose rights or interests are included in the legal scenario, which constitutes the object of the potestative right.
- [10] Stoica, V., op.cit., vol.I, pp.135.
- [11] Pop, L., "*Tratat de drept civil. Obligațiile*", vol.I, "*Regimul juridic general sau ființa obligațiilor civile*", ed.C.H.Beck, București, 2006, pp.358.
- [12] Reghini, I., op.cit., pp.241.

# CSR Crystallization in the Financial System: the World Bank Model

Georgiana-Loredana Frecea  
*The Bucharest University of Economic Studies*  
*Economics and International Affairs Doctoral School*  
[frecealoredana@yahoo.com](mailto:frecealoredana@yahoo.com)

## Abstract

*The global financial system is marked by a series of destabilising trends caused by the effects of corporate irresponsibility during the recent years, that lead to the diffusion of global crises. The role of international financial institutions to strenghten and to promote the principles of social responsibility, as well as the role to develop transparent CSR reporting, can be best highlighted by the World Bank.*

*The purpose of this article is to outline the main directions in the field of corporate social responsibility in the financial system, based on the strategy adopted by the World Bank. First of all, there will be investigated the institutional premises of the emergence and development of CSR processes in the financial system and the correlations between CSR and macroeconomic progress. It will continue with a literature review of CSR models that are included in the 2015 World Bank Global Reporting Initiative (GRI) Index.*

**Key words:** corporate social responsibility, World Bank, financial system

**J.E.L. classification:** M14

## 1. Introduction

This article starts with the irresponsibility premises manifested in the financial system that lead to the global crises and strengthened the necessity of CSR efficient practices in this field. This analysis took into account the history of the financial crisis, establishing an appropriate correlation between the financial system – corporate social responsibility – market coordinates and not forget to mention the institutional implications of CSR development at a global level.

The analysis will focus on social

responsibility within the central banks, emphasizing the World Bank CSR policy. Financial institution with a major impact on the global economy, the World Bank focuses on responsible and rational use of financial resources, in order to validate a coherent international financial system. This will conduct to a positive economic development of the countries on a sustainable basis.

Despite the differences in reporting standards, the Global Reporting Initiative (GRI) is considered in the specialised literature one of the most comprehensive CSR reporting frameworks, including key guidelines that will be pursued in order to validate the formulated hypothesis. Given the difficulty of establishing precise indicators to measure CSR performance, the existence of limited instruments and indicators that do not take into account the multiple sides of corporate social responsibility, will be proposed to focus the analysis on the GRI Index 2015.

## 2. A multiple view of the CSR process in the financial field

Corporate social responsibility concept opposes in a perfectly symmetrical registry, the corporate social irresponsibility. While the first is a concept whereby companies integrate social and environmental concerns in their business operations and in their interaction with their stakeholders on a voluntary basis [1], the second is defined by theoreticians as a set of corporate actions which affect in a negative way the legitimate requirements of social stakeholders identified. [2]

The need of the financial institutions around the world to take responsibility is stated by the major imbalances in the global market, representing both a reaction to the crisis and a way to regain the „institutional legitimacy” of the banking system. Thus, the



natural response to the destabilizing forces that lead to some deep recession is restoring a natural order in the multifaceted relationship: financial system – corporate social responsibility – market coordinates.

This analysis does not propose to evaluate the economic crisis effects on CSR, because the intensity of the crisis has spread disproportionately in different countries, creating irregular responses in Europe and worldwide. The supported hypothesis is that there is a direct relationship between CSR and international circumstances from the financial system, the emphasis being found on the financial market coordinates which has the power to reset the world economy. Accordingly to this perception, the wrong management of financial risk and poor organization of payment systems led to deep crisis in the global system, which are amplified by the irresponsible attitude of global institutions in an effective intervention on these markets.

The financial system is a key component of any national economic aggregate, having effects with a high rate of transferability on the international environment, given the characteristics of globalization which is manifested increasingly in the last decades. The possibility of banks or other financial institutions to interfere in the borrowers activity by imposing responsible principles, may confer to financial system the role of „vehicle” in the CSR development and crystalization. Thus, to the financial system is attached the role of direct and indirect influence through CSR.

The current crisis gives the opportunity to companies to redirect CSR from a threat to an opportunity. [3] Starting from the cash deficit in the banking system which led to the global financial crisis (2008), the exposure of financial markets to the major imbalances through a domino effect and continuing with the difficulties in borrowing capital from the banks, the impact of the actions on the financial market cannot be limited only to the collapse of financial institutions, but also to the profound degradation of relations on other markets (for example goods market, currency market, labor market).

The wrong management of loans has led to the beginning and to the deepening crisis, the banks acting in the post-crisis period by developing financial education programs

among the population, which were aimed to disseminate the information on the rational use of bank instruments and credits. As a consequence, the financial circumstances lead to changes in strategies for individuals, companies (multinational and SMEs), but also in national policies set by the government forces.

### **3. Global actors in shaping CSR – the World Bank**

International organizations worldwide are trying to establish an agreement on CSR issues, but key players in this field can be considered the financial corporations and financial institutions from the bank system. These can lead to serious dissociations in the social, business and environment sphere, due to the direct effects, but mostly indirect effects of their current activities. This paper starts from the idea that the banks' clients come from various sectors of activity, which is why banks are designed to highlight the areas in which environmental, social and ethical risks have a high probability of manifestation. [4]

Central banks remain the main actors in the financial markets, operating as supporting agents in establishing a strategy to sustain the financial stability. In this category are also included financial global institutions that are trying to develop accurate CSR policies and strategies, along with outlining international frameworks in order to standardize the reporting activities. The role of the banks was completely changed by integrating the direct and indirect risks in lending policies, risks associated with loans granted to customers with poor sustainable performance.

In the following part, it will be taken into account the importance of CSR reporting, in order to standardize CSR practices worldwide. This article aims to identify the institutional premises of the emergence and development of CSR by focusing on the World Bank and the capacity of this global institution to influence CSR practices nationwide. Corporate social responsibility has evolved in the same direction with the development of global institutions, which have tried to link CSR concepts with the international CSR frameworks. On the other hand, CSR standardization highlights the heterogeneity of the concept, according with

characteristics of national systems and regional or temporal variations.

International financial institution with an essential role in attracting and distributing financial resources, the World Bank assumes a number of social responsibility and environment principles, promoting financial sustainability of the countries. In order to achieve a realistic overview of CSR activities of the World Bank, this paper will proceed to a detailed analysis of 2015 GRI Index, emphasizing economic performance issues, completed by social and environmental responsibility. Global Reporting Initiative (GRI) is a recognized framework in CSR reporting and is currently used in different parts of the globe in an attempt to give consistency and credibility to the CSR actions.

#### 4. 2015 World Bank GRI Index

One of the most complete CSR reporting framework is considered the Global Reporting Initiative Guideline, which can be applied to all organizations and companies, regardless of geographical localization, size or sector. The negative effects of the financial crisis (2008) concerning the trust in the banking system have increased their reputational risk, inducing a focus on transparent reporting of CSR practices.

Thus, the financial services have particular characteristics in terms of reporting, taking first place among sectors according to GRI reports. GRI data available on 30.09.2015 reveals that the financial services sector takes the first place in reporting CSR activity. Table 1 confirms the decisive role of the financial system among the global network.

*Table 1 CSR reporting according to sectors of activity*

No.	Sector	2013 (%)	2014 (%)
1	Financial Services	12.54	12.53
2	Energy	6.64	6.49
3	Food and Beverage Products	5.74	6.02
4	Energy Utilities	4.31	3.89
5	Mining	4.19	3.65
6	Chemicals	3.58	3.54
7	Real Estate	3.16	3.38

8	Construction	3.06	3.24
9	Technology Hardware	2.93	3.13
10	Telecommunications	2.93	2.91

Source: Global Reporting Initiative

While the World Bank Group consists of five international financial institutions, the World Bank, whose report will be considered further, include the International Development Association and the International Bank for Reconstruction and Development. The World Bank Group efforts are currently directed to sustainable growth and reducing extreme poverty, in order to achieve long term results.

The World Bank works with its borrowing country members to achieve equitable and sustainable economic growth in their national economies and to find solutions to pressing regional and global problems in economic development and in other important areas, such as environmental sustainability. [5] The report 2015 World Bank GRI Index propose a distinction between "operational" indicators and "corporate" indicators, relating both to the impact on customers and to internal operations of the Bank.

The human dimension is a key aspect in the studies relating to the corporate social responsibility, because the employees are considered representative stakeholders for the organization. Regarding the workforce, the World Bank is an example of responsible employer, with an estimated 11.933 full-time staff and 4.262 full-time-equivalent short-term consultants.

*Figure 1 Evolution of the full-time staff, World Bank*

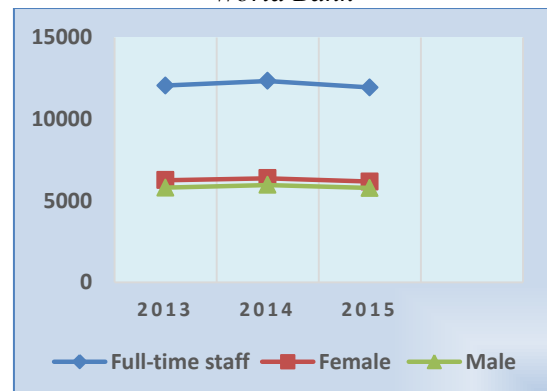

Source: World Bank

Figure 1 highlights the principles of non-

discrimination in CSR practice. The World Bank maintains an equitable balance of the workforce between female and male, in accordance with the provisions of human rights and social justice. According to Eurostat database, at the European Union level, the employment rate was 59.5% for women, while the employment rate for men was 70.1% (2014).

Another issue with significant consequences at the global level is the percentage of people working in the World Bank from outside the USA (40%), the organization directly contributing to reduce unemployment rate in other countries (170 nations) and thus, to increase their living standards.

A high level of social responsibility means increased efforts for training activities provided to employees on human rights issues. As it is shown in the Figure 2, the World Bank has provided such training for 500 staff members in Washington, DC, in the fiscal 2015, representing 144 hours (24 sessions). Other training workshops were hosted by the regional offices.

Figure 2 Training on human rights policies provided to the World Bank employees

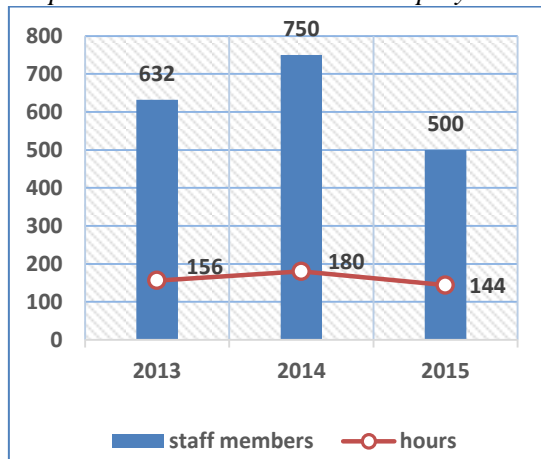

Source: World Bank

Corporations, in general, and international financial institutions, in particular, have a significant impact on issues regarding human rights. The World Bank has a clearly defined Code of Conduct that promotes diversity within the financial institution, vigorously combating discriminatory practices. The bank also supports career development activities for the employees on an equal basis, focusing on equal treatment between

persons irrespective of their religion or belief, disability, age or sexual orientation.

It cannot be omitted the investments in human resources by funding projects with positive role in facilitating the community access to water resources and food, education and health system. In this regard, each project is subject to a review process in CSR priority areas, indicating possible mismatches with the international social safeguard policies.

The indirect economic impact relates to the infrastructure development projects supported by the World Bank through loans for the customers in sectors such as: information, transport, communications, water and energy. On the other hand, the bank has a close relationship with the indigenous population to whom he address. The projects affecting the local community must obtain its support before financing.

It follows that, according to the model provided by the World Bank, the corporate social responsibility in the financial system must be linked to human rights and cultural values, dignity and special needs of the native population. The effects of global warming and the wrong management of waste are just some of the reasons which have led to the inclusion in the CSR agenda of the banking system, in addition to financial targets, those relating to the environmental protection.

In accordance with Figure 3, the bank had a portfolio of 299 biodiversity conservation projects from the fiscal 2006 to 2015, worth 1.078 billion dollars. In the same period, 87 projects were focused on habitat-protected or restored areas, as resulting from data provided by the World Bank. From the fiscal 2006 to 2015, there were five projects directed towards habitat restoration. The report also indicates that the World Bank is making efforts to reduce energy consumption, which decreased by 28,583 GJ in fiscal 2014, along with various measures to reduce the greenhouse gas emissions.

Figure 3 CSR activity of the World Bank on the environment, 2006-2015

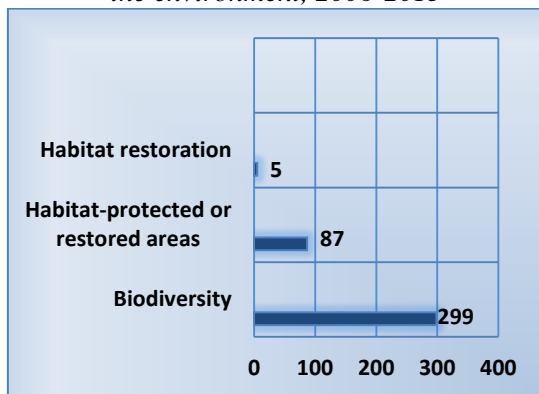

Source: World Bank

The social safeguard and environmental policies of the World Bank have an essential role in mitigating the negative impact on states, reducing the risks through a careful analysis of proposed projects for funding in compliance with the procedures established by the bank. Each project must meet certain requirements and will be verified on several levels, before the final approval of the Board of Directors. This stage will be followed by a monitoring process that aims to fulfill the key objectives of the World Bank.

## 5. Conclusions

According to the analysis, it can be concluded that the financial system plays a major role in CSR global development, both through direct effects of the activities that are carried out, but mostly through the indirect effects, arising from loans for the customers. At the same time, the global crisis starts from financial premises and the effects of social corporate irresponsibility that have convert it into a global phenomenon.

The awareness of CSR impact on communities after the crisis had a substantial role in the growth and the qualitative improvement of reporting CSR activities, many corporations and financial institutions using standardized reporting frameworks, which are internationally recognized.

The diversity of the economic environment, the disproportionate emergence of financial constraints worldwide and the market coordinates which vary from one nation to another, lead to the conclusion that CSR standardization is difficult to achieve. Instead, creating a common framework for CSR reporting practices provide consistency

to continuous efforts to legitimate the corporations. Using Global Reporting Initiative guidelines in corporate social responsibility reporting provides an overview that can be easily understood through comparative analysis.

The World Bank is an international organization with strategic goals that guide its major initiatives: to eradicate extreme poverty and to boost common prosperity. The bank folds its activity according to an evolving CSR strategy. The progress made in recent years has been highlighted by the data included in the 2015 GRI Index, results that can be a model for other financial and banking institutions worldwide.

The information extracted from this article are useful because provides relevant lines of actions for financial sector institutions, including central banks from different countries. Following some sustainability models by national central banks can give to the entire national financial system a base of stability and can import sustainable development elements.

The analysis emphasizes that the CSR reporting and the practices provided by the World Bank may become a starting point for developing other CSR models in the national banks and in the global banking and financial system. But each national economy requires special attention and the appropriate adjustment measures by establishing a coherence between the financial system – corporate social responsibility – specific coordinates of the market.

## 6. References

- [1] Commission of the European Communities, "Promoting a European Framework for Corporate Social Responsibility", *Green Paper COM(2001) 366 final*, Brussels, 2001, p. 6.
- [2] Strike, V. M., Gao, J., Bansal, P., „Being Good while Being Bad: Social Responsibility and the International Diversification of US Firms”, *Journal of International Business Studies*, 37, 2006, p. 852.
- [3] Giannarakis, G., Theotokas, I., "The effect of financial crisis in corporate social responsibility performance", *International Journal of Marketing Studies*, vol. 3, no. 1, Canadian Center of Science and Education, 2011, p. 6.
- [4] Matei, M., Voica, M.C., "Social responsibility

- in the financial and banking sector", *Economic Insights – Trends and Challenges*, vol. II (LXV), no. 1, 2013, p. 117.
- [5] World Bank, „2015 GRI Index”, Washington, DC., 2015, p. 26.

## Romania's Electrical and Optical Equipment Industry Position on Global Value Chain in 2001-2011 periods

Cristiana-Ioana Șerbănel

*The Bucharest University of Economic Studies, Faculty of International Business and  
Economics*

[cristiana.serbanel@gmail.com](mailto:cristiana.serbanel@gmail.com)

### Abstract

*Active participation into Global Value Chain definitely can bring considerable benefits like job creation, transfer of knowledge and economic growth. But, to reap those gains, a country must have the right investment policies and a positive trade flow. This paper has analyzed Romania's position within global value chain considering Electrical and Optical Equipment using WIOD database in 2001-2011 periods. It provides the answer to questions such as: How much does Electrical and Optical Equipment sector depend on international inputs? On which sectors does it depend on? Which are the countries that mostly contribute to domestic production on Electrical and Optical Equipment Industry?*

**Key words:** Global value chain, World Input Output Database, Electrical and Optical Equipment sector, Romania

**J.E.L. classification:** F1, F14, F23

### 1. Introduction

The omnipresence of global value chain (GVC) in production processes around the world, with a focus on manufacturing industries, is undisputable. This new trend influence not only international trade between major economic blocks such as United States, European Union (UE) and Asia but also enhanced the importance of regional linkages (eg.: European regional production networks). Zooming from a worldwide perspective to a national approach, we will focus in the present paper on Romania's position in the global value chain.

Strong empirical evidence supports the role of the global value chain and its economic impact on the modern economy: 75% of world trade is now comprised of intermediates inputs and capital goods and services. [1] But, not all countries succeed to integrate into GVCs. Although, in the last two decades there have been noticed an enhancement in participation – “low-income developing countries (LIDCs) are still hugely under-represented in GVCs – only about 11% of the total world gross exports in 2011 (up from 6% in 1995).” [1] Considering Small and Medium Enterprises (SMEs) participation, which represent the vast majority of firms in all countries, surprisingly they contribute to less than half to exports. In real, when SMEs take the party into GVCs, usually they involve indirectly, meaning that they are suppliers for firms that export, but do not export themselves.

This paper analyzes electrical and optical equipment sector's position in the global value chain. Why have I chosen this industry? Because it shapes “the new economy”, it helps both the innovation and research sector and the information and communication technology sector. This area is comprised both on multinationals and on SMEs, and there should be a balance in rapping gains between both.

Electrical and optical equipment sector produces a broad range of mostly high-technology products such as computers, cables and batteries, telephones, TV sets, electric motors, watches, electro-medical equipment and others. This sector is a skill-intensive one, and it drives the motor or research and development. [2]

Today, in Romania several such companies are performing in electrical and optical equipment industry (eg.: Elsaco Electronic Srl, Electro-Alfa International Srl, Aquaterm Srl, Electric Start Srl, Optim Trafo

Srl, Energosin Srl). [3]

## 2. Methodology

The World Input-Output Database (WIOD) contains information on increasingly production fragmentation and provides the opportunity to analyze the consequences of it. It covers 40 countries, including all 27 countries of the European Union (UE). WIOD contains data for 35 industries covering the entire economy, including agriculture, mining, utilities and construction, 14 services industries and 14 manufacturing industries. The data is gathered from national input-output tables and international trade statistics.

According to with Timmer, in the manual of usage of WIOD available online at [http://www.wiod.org/publications/source\\_docs/WIOD\\_sources.pdf](http://www.wiod.org/publications/source_docs/WIOD_sources.pdf), for a country A, flows of products both for intermediate and final use are separated into domestically produced or imported. Timmers's manual present the model we have used to interpret the results regarding the Intermediate use by country of exports from Romania by sector is. [4]

## 3. Romania's Electrical and Optical Equipment Industry in 2001-2011 periods

### 3.1. How much does Electrical and Optical Equipment sector depends on international inputs? On which sectors does it depend on?

To remain competitive on the international market is a challenge. The country's aptness depends both to import high-quality inputs and on the aptness to export. According to WTO [5] the value-added content of exports for Romania is composed as follows: 75.8% domestic content and 32.4% foreign content as a percentage of gross exports. Concerning the share of origin of the value-added content of exports, Romania has 76 % domestic contribution and 24% foreign contribution. Further on will be presented Romania's position in the global value chain considering Electrical and Optical Equipment through empirical evidence.

According to with my calculations, Basic Metals and Fabricated Metal and Electrical and Optical Equipment sectors

remained in the top Romanian exporting sectors used as intermediates in other foreign countries (for both 2001 and 2011). Focusing on Electrical and Optical Equipment, there can be noticed an increase of +5.8% in 2011 compared to 2001. In 2001, the total value of exports counted 226 millions of US\$, while, in 2011 it increased to 1545 million of US \$.

The most important global sectors that exports are used as intermediates in Romanian production process in Electrical and Optical Equipment Industry are:

- Electrical and Optical Equipment (with an increase in value of exports from 166.048 million USD in 2001 to 782.703 million USD in 2011),

- Basic Metals and Fabricated Metal (with a rise in value of exports from 32.326 million USD in 2001 to 270.290 million USD in 2011),

- Rubber and Plastics (with an increase in the value of exports from 18.132 million USD in 2001 to 61.244 million USD in 2011).

Additionally, Chemicals and Chemical Products sector registered a notable increase in the value of exported inputs used as intermediates in Romanian production from 9.363 million USD to 78.505 million USD. See Table 1.

*Table 1: Foreign sectors used as intermediates to domestic production in Electrical and Optical Equipment Industry in Romania (millions USD, 2001-2011)*

Sector	Total value 2001	Percentage of total intermediates used by Romania for Electrical and Optical Equipment	Total value 2011	Percentage of total intermediates used by Romania for Electrical and Optical Equipment	% (Δ 2001 compared to 2011 in value)

		expo rts in all 35 secto rs (%) (200 1)		nt of expo rts in all 35 sect ors (%) (201 1)	
Electrical and Optical Equipmen t	16 6.0 48	59.3 52	782 .70 3	52.6 12	3.7 14
Basic Metals and Fabricated Metal	32. 32 6	11.5 55	270 .29 0	18.1 68	7.3 61
Rubber and Plastics	18. 13 2	6.48 1	61. 244	4.11 7	2.3 78
Chemicals and Chemical Products	9.3 87	3.35 5	96. 222	6.46 8	9.2 50
Machinery , Nec	9.3 63	3.34 7	78. 505	5.27 7	7.3 84
Transport Equipmen t	4.4 53	1.59 2	21. 043	1.41 4	3.7 25
Other Non- Metallic Mineral	2.6 98	0.96 5	10. 754	0.72 3	2.9 85
Manufactu ring, Nec; Recycling	2.4 71	0.88 3	7.0 25	0.47 2	1.8 43
Pulp, Paper, Paper , Printing and Publishing	2.1 25	0.76 0	12. 999	0.87 4	5.1 16
<i>Total</i>	<i>24 7.0 05</i>	<i>88.2 89</i>	<i>134 0.7 84</i>	<i>90.1 25</i>	<i>43. 757</i>

Source: Authors calculation based on The World Input-Output Database (WIOD, 2001 - 2011)

### 3.2. Which are the countries that mostly contribute to domestic production on Electrical and Optical Equipment Industry?

The most important partners in providing intermediate inputs used in Romanian production process in Electrical and Optical Equipment Industry for both 2001 and 2011 are Germany, Italy, and France. The value of exported inputs used as intermediates in Romanian production process coming from Germany increased from 65.018 million USD (2001) to 396.740 million USD (2011). Italy had also registered a notable increase from 44.083 million USD in 2001 to 161.791 million USD in 2011.

France increased its export value used as intermediate in domestic production from 27.597 million USD in 2001 to 86.766 million USD in 2011. Additionally, Hungary has strengthened its value of exports used as intermediates in Romanian production process in Electrical and Optical Equipment Industry 12 times, from 8.847 million USD to 120.410 million USD.

Table 21: The origin of countries which exports are mostly used as intermediates in Romanian production in Electrical and Optical Equipment Industry in Romania (millions USD, 2001-2011)

Coun tries	Value of export s used as interm ediate s in Roma nian produc tion by countr y (millio ns of US\$) 2001	Perc enta ge of total Roma nia n usag e of imp orte d goo ds as inter med iate s (200 1)	Value of expo rts used as inter media tes in Roma nian produc tion by countr y (milli ons of US\$) 2011	Perc enta ge of total Roma nia n usag e of imp orte d goo ds as inter med iate s (201 1)	% (Δ 20 11 comp are d to 20 01 in ter ms of val ue)
DEU	65.018	23.2	396.7	26.6	5.1



		40	40	68	02
ITA	44.083	15.7 57	161.7 91	10.8 75	2.6 70
FRA	27.597	9.86 4	86.76 6	5.83 2	2.1 44
AUT	21.458	7.67 0	93.40 7	6.27 9	3.3 53
GBR	12.142	4.34 0	38.11 6	2.56 2	2.1 39
USA	12.129	4.33 6	17.63 4	1.18 5	0.4 54
TUR	8.887	3.17 6	66.37 2	4.46 1	6.4 68
HUN	8.847	3.16 2	120.4 10	8.09 4	12. 61 0
CZE	7.583	2.71 0	51.73 8	3.74 7	5.8 23
POL	6.820	2.43 8	55.73 8	3.74 7	7.1 73
Total	214.56 4	76.6 93	1088. 712	73.4 50	47. 93 7

Source: Authors calculation based on The World Input-Output Database (WIOD, 2001 - 2011)

#### What should Romania do to enhance its integration into global value chain?

OECD conducted a study covering developing sub-regions within Asia, Africa, and the Middle East and concluded what should be done to enhance the participation into GVCs. I consider that these measures if they will be correctly implemented, will bring tremendous benefits to Romanian producers. [6] There should be both structural and policy changes. In particular, Romania's authorities should pay more attention in lowering import tariffs and engage into regional trading agreements. Additionally, there is a need for inward openness to foreign direct investment, logistics performance, quality of infrastructure and institutions and intellectual property protection.

In this sense, Romania's government will implement new taxation regime: manufacturing companies will benefit till 31 December 2016 of tax exemption for reinvested profits in the acquisition/production of technological equipment. [7]

Also, there have been registered an increase in income in this sector. This augmentation is due to individual bonuses, the amount of net profit and other funds, and achievement of production or higher cashing, according to National Statistics Institute (INS). There have been registered a rise between 3.5% and 7% in the manufacture of computer, electronic and optical products, other manufacturing, textiles, electric equipment, production of tobacco, leather and (including the manufacture of luggage, saddlery, handbags, and harness; dressing and dyeing of fur). [8]

#### 4. Conclusions

The current wave of globalization is under the influence of global value chains and interconnectedness of economies. There do not exist any concrete definition. However, it involves the entire set of operations that companies undertake from the conception of a product or service to its final use. Factor such as liberalization, technological progress, reduction in transportation costs, access to resources and markets and a continuous seek for increased efficiency around firms according to the comparative advantage of different geographical areas have been eased production fragmentation.

In the present, more than half of global manufactured imports are in intermediate inputs, and more than 75% of world services imports are intermediate services.

This paper has conducted an introductive analysis on positioning Romanian's electrical and optical equipment Industry on GVC using WIOD and 2001 and 2011 as reference years.

The most important global sectors that exports are used as intermediates in Romanian production process in Electrical and Optical Equipment Industry are Electrical and Optical Equipment, Basic Metals and Fabricated Metal and Rubber and Plastics. Additionally, Chemicals and Chemical Products sector registered a notable increase in the value of exported inputs used as intermediates in Romanian production. The most important partners in providing intermediate inputs used in Romanian production process in Electrical and Optical Equipment Industry for both 2001 and 2011 are Germany, Italy, and France.

## 5. References

- [1] OECD, “Istanbul G20 Trade Ministers Meeting: Presentation of the OECD-WBG inclusive global value chains report” G20 Trade Ministers Meeting, Istanbul, Turkey, 6 Oct 2015 Available online at <http://www.oecd.org/development/istanbul-g20-trade-ministers-meeting-presentation-of-the-oecd-wbg-inclusive-global-value-chains-report.htm>
- [2] WIIW Industry Studies “Development and Prospects of the Electrical and Optical Equipment Sector in the Central and Eastern European Countries.” Available at <http://wiiw.ac.at/developments-and-prospects-of-the-electrical-and-optical-equipment-sector-in-the-central-and-eastern-european-countries-dlp-93.pdf>
- [3] Centrul Transfrontalier de Consultanță în Afaceri “Cercetare, Dezvoltare și High Tech. Industria de echipamente electrice și optice”. Available online at [http://www.cciabt.ro/centru/botosani\\_firme/ia\\_si3.html](http://www.cciabt.ro/centru/botosani_firme/ia_si3.html)
- [4] Timmer, M. (2012) “The World Input-Output Database (WIOD) Contents, Sources and Methods,” pg. 4, 63. Available online at [http://www.wiod.org/publications/source\\_docs/WIOD\\_sources.pdf](http://www.wiod.org/publications/source_docs/WIOD_sources.pdf)
- [5] WTO (2014) International Trade Statistics 201. Available at <http://www.wto.org/its2014>
- [6] OECD, “Participation of Developing Countries in Global Value Chains: Implications for Trade and Trade-Related Policies” OECD Countries” , 2001-2002. Available online at <http://wiiw.ac.at/developments-and-prospects-of-the-electrical-and-optical-equipment-sector-in-the-central-and-eastern-european-countries-dlp-93.pdf>
- [7] Forbes – Andrei Panait „ Forbes Best Cities 2015, locul 32: Buzău”, May 2015. Available online at <http://www.forbes.ro/articles/forbes-best-cities-2015-locul-32-buzau-38119>
- [8] Dorin Cocis “Salariile din România au crescut. Câștigul salarial mediul net, mai mare în septembrie decât în august”, Dej24. Available online at <http://dej24.ro/salariile-din-romania-au-crescut-castigul-salarial-mediul-net-mai-mare-in-septembrie-decat-in-august/>
- [9] Trade Policy Paper No. 179, 2015, pg.18. Available online at <http://oe.cd/trade-papers>

# Developing Sustainable Human Resource Management in a Shipping Company - A Study Case

Ioana Farkas- Surugiu

*The Bucharest Academy of Economic Studies, Romania*

[ioana.g.surugiu@gmail.com](mailto:ioana.g.surugiu@gmail.com)

Vanessa Just

*The Bucharest University of Economic Studies*

[vanessa.just@bshg.com](mailto:vanessa.just@bshg.com)

Andreas Bartels

*The Bucharest University of Economic Studies*

[andie.bartels@gmail.com](mailto:andie.bartels@gmail.com)

## Abstract

*The article presents some aspects regarding the human resource management maturity level of a shipping company and how might this influence the efficient performance of the company. To reach the objectives, questionnaires have been developed in order to measure seafarers' perception over ashore middle management commitment and investigate how the level of their satisfaction determines the efficiency of the operations on board.*

**Key Words:** sustainability, human resource management, key operational elements

**J.E.L. classification:** O15

## 1. Introduction

The way the world is changing places human resource management in the spotlight [1], human resource professionals confronting a wide range of changes in workforce demographics, technology and competitiveness [2]. It was suggested that these trends highlighted the need for more sustainable human resource management practices, placing sustainability as a strategic potential in this process [3]. Based on this theory, the research undertaken within the management area highlighted that there are various essential factors that count for the smooth development of tasks within organizations, such as: a) an effective leadership style, which would fit the organizations' needs and b) managers who

would maximize the output of the organization through administrative implementation [4]. It might be understood that crucial in the organizations' resources are the people involved in the business, who must be attentively chosen and suitable for the tasks undertaken, in order that the organization's aims to be successfully attained. Human resources management covers a set of relational info policies with an ideological and philosophical support [5] with four aspects that are needed for its full version: a particular network of "creeds and allegation, decisions of information", "strategic confidence of level management", "the central involvement of level managers, trust in a small set of rules designed to harmonize" and a proper matching of employment relations and relationships between employees [6].

As shipping is an international business, human resources management responsibilities have to include executive and leadership development, performance management, compensation and labour relations [7]. Furthermore, employee satisfaction is an essential element to the success of any business, a high rate of employee contentedness being directly related to the turnover rate. Thus, keeping employees' satisfied with their careers should be a priority for companies in order to develop durable and sustainable affairs. [8]. Employee satisfaction includes employees' work-related happiness in terms of fulfilling their work needs and desire for achievement [9]. Connected to the above approaches investigated, other matter arises concerning

the process of developing employees, which is about preparing them for taking on more sustainable responsibilities in the future. On the other hand, it was highlighted that it is not good only for the employee, but crucial for the employer, who must plan for future human resource needs at both the managerial and entry levels. Furthermore, effective development programs ensure staff is retained, and that motivation and commitment are enhanced through promotion opportunities for all employees over the longer term. As a matter of fact, training is a big part of developing staff and assisting them to reach their true potential [10]. Managers must ensure that job skills and knowledge of their employees are kept current through training and development. Employee training improves the employees' job performance by changing their skills, knowledge, attitudes or behavior [11]. A well-organized and well-presented training program develops and maintains an organization's sustainable competitive advantage and places the on-going as critical due to rapid technological change and global competition. [12]. There are certain unique characteristics of the seafarer's occupation that have to be considered when studying the psychological work environment on board ships. The occupations of seafarers and the crews on ships as a whole differ a lot from land-based workplaces [13]. Human resource management in shipping is a peculiar and niche branch, so developing responsible and sustainable practices on board might be regarded from many angles, both internal and external factors being taken into consideration. Thus, sustainable human resources management focuses on optimally utilizing and respecting human workforces within the organization, in which an explicit relationship is built between an organization's strategic policies and its environment [14]. Moreover, it was suggested that human resources management might leverage corporate social responsibility strategies to deliver greater benefits for the business, for employees, for society, for the environment and ultimately, for HR professionals themselves [15].

## 2. Research Methodology

To achieve the objectives of this paper, a primary research within a shipping company within European Union was undertaken. Seafarers occupying managerial positions on board the company's vessels (positions such as chief mate and master) were given questionnaires to assess their perception over the middle management commitment ashore. They were asked to score a range of key operational elements on a scale from one to ten. The total number of respondents was 48 (24 vessels). The respondents were asked to rate several options:

- The overall assistance/ guidance/ reliability received from the middle management ashore.
- The promptitude of the guidance (coating, cargo documents, bill of lading, charterers relationship) received.
- The interference of Cargo Department with the vessel operations.
- The use of Risk Management tools with regard to cargo and commercial operations
- The participation in training programmes with regard to cargo and commercial operations (except Safety of Training, Certification and Watchkeeping).
- Cargo and commercial communication: communication between the vessel and the company on cargo and commercial matters, daily communication of cargo related matters (expressing how policies were implemented).

## 3. Research results

*Table 1. The percentage of seafarers who rated the key operational elements*

Key operational element	Percentage of seafarers rated between 1 - 5	Percentage of seafarers rated between 6 - 10
Assistance	8.33%	91.6%
Promptitude	41.6%	58.4%
Interference of	27.1%	72.9%

Cargo Department		
Use of Risk Management tools	7%	93%
Training Programmes	6.25%	93.75%
Cargo and commercial Communication	31.25%	68.75%

Source: Author's Survey October 2015

Table 2. Number and percentage of seafarers who rated between 8 – 10

Key operational element	Number of seafarers rated between 8 - 10	Percentage of seafarers rated between 8 -10
Assistance	31	64.5%
Promptitude	12	25%
Interference of Cargo Department	28	58.3%
Use of Risk Management tools	35	72.9%
Training Programmes	30	62.5%
Cargo and Commercial Communication	23	47.9%

Source: Author's Survey October 2015

#### 4. Perceived assistance and the interference of operational leaders on the vessels' operations

Risk assessment, situational awareness and mitigation are the essential tools in the development of a cargo and commercial culture [16]. The ability to carry out and take responsibility of the process should be owned by all employees and commercial awareness should be highly integrated in all work tasks and operations. Furthermore, cargo and commercial operations must be lead and driven like any other performance area. As presented in Table 1., 91.6 per cent of participants rated between 6- 10 this showing a high level of satisfaction related to the way they have been assisted in operations. This key operational element might be regarded as

a mean of offering seafarers opportunities to learn and improve their skills.

Making available opportunities to learn is motivational because it enables employees to grow and develop, which provides a route to fulfilling their potential. As employees learn new skills, they become more competent to complete more complex tasks [17]. Their competency satisfies their need of achievement increasing their level of satisfaction towards their job, as a result developing a strong psychological connection with the company's principles and developing a durable business relationship [18].

#### 4.1 Risk management tools

Sustainability in maritime transport, as encouraged by the Tanker Management Self Assessment programme (TMSA), is crucial for the smooth running of a safety management system. As highlighted in this compulsory risk management tool, the elements related to staff, leadership and recruitment strategies are essential for the efficient functioning of the bulk liquid shipping business. Moreover, as it was enlightened, the requisite of vessels having competent crews capable of working as effective teams operating safely without the risk of accident is fundamental. Defined responsibilities and accountabilities at all levels within the organizations ensure high standards of functioning [19]. Benefits for Risk Management [20]:

- Explicitly addresses uncertainty
- Based on the best available information and takes human and cultural factors into account
- Is dynamic, interactive and responsive to change
- Facilitates improvement and enhancement of the organization

#### 4.2 Training programmes

Employee training improves the employees' job performance by changing their skills, knowledge, attitudes or behaviour towards their co-workers, managers and the company. Indications such as technological breakthroughs, extensive use of computers, etc. should ensure that proper training is available for all the employees of a company

[21]. As a result, a large variety of companies provide programs that include trainings, in-house seminars, workshops and conferences [22]. As presented in Table 1., participant rated accordingly: 93.7 per cent of seafarers rated between 6 - 10 the quality of the training programmes undertaken by the shipping company.

### 4.3 Weaknesses suggested regarding the key operational elements investigated

In general, seafarers' feedback indicated that the level of satisfaction regarding the company's tactics to achieve sustainable human resource management is above average. Although within the shipping industry there are various unwritten regulations concerning fast and reliable reply to queries and prompt guidance when required as a prerequisite of safety, it might happen that to issues that arise on board of the vessels to be necessary to give more thought and analysis in order to make the best decision, costs and time being fundamental problems. This might result in various stressful circumstances for both crews on board and management team ashore. In the present study, 41.6 per cent of the seafarers rated between 1 – 5 the key element related to the promptitude. Ways of improving promptitude:

- Increase the number of employees (specialists)
- Provide training on same matters to different employees
- Developing team- work sustainable strategies (duties and responses planned ahead considering presumptive risks/ risk management tools) [22].

### 5. Conclusion

The paper reveals the results of a research in a shipping company, focusing on seafarers' perception concerning key operational elements that might influence their performance. Seafarers' level of satisfaction with regard to this range of factors was measured, in an attempt to highlight what motivates them to efficiently perform and to develop sustainable operations within their duties, in accordance with the company's advanced principles.

Overall, results were satisfactory, key operational elements being rated by the majority of seafarers above 5. The only weakness was registered concerning promptitude, this approach being prone to have a psychological aspect. Analyzing the results, it might be said that the late regulations within the industry and the continuous struggle of the shipping companies through their operational leaders who developed operational plans and improved the key operational elements concluded in more sustainable and durable operations, saving costs and avoiding safety related issues.

### 6. References

- [1] Stopford, M., *Maritime Economics*, 3rd Ed., Cambridge, GB: Routledge, 2007.
- [2] Losey, M., Meisinger, S., Ulrich, D., *The future of human resource management*, New Jersey, United States of America: John Wiley & Sons, Inc., 2005.
- [3] Ehnert, I., *Sustainable Human Resource Management: A conceptual and exploratory analysis from a paradox perspective*. Berlin, 2009.
- [4] Kotter, J. P., *Leading change*. Cambridge, MA: Harvard Business School Press, 1966.
- [5] Storey, J., *New Perspectives on Human Resource Management*. London: Routledge, 1989.
- [6] Chasoviski C., "Human Resources Management Maturity Model. Toward A New Model" ,*The Annals of The "Ștefan cel Mare" University of Suceava. Fascicle of The Faculty of Economics and Public Administration*, Vol. 11, No. 2(14), pp. 143-148, 2001.
- [7] Koliou, S., "Management Concepts and Their Application in the Maritime Industry", North West Kent College, course notes, 2012/2013.
- [8] Storey, J., *New Perspectives on Human Resource Management*. London: Routledge, 1989.
- [9] Koliou, S., "Management Concepts and Their Application in the Maritime Industry", North West Kent College, course notes, 2012/2013.
- [10] Detert, J. R., Pollock, T. G. , "Values, interests, and the capacity to act: Understanding professionals' responses to market-based improvement initiatives in highly institutionalized organizations", *Journal of Applied Behavioral Science*, 44, 2008, pp.186-214.
- [11] Hunsaker, P., Tony, A., *The art of managing people*, 2nd Ed., New York, United States of America: Free Press, 1986

- Guest, D.E. , "Human resource management and industrial relations", *Journal of Management Studies* 24(5), pp. 503–520, 1987.
- [12] Koliou, S., "Ship Operations" course notes, Lloyds Maritime Academy
- [13] Kristiansen, S., *Maritime transportation: Safety management and risk analysis*, Amsterdam: Elsevier/Butterworth-Heinemann, 2005.
- [14] De Prins, P., Van Beirendonck, L., De Vos, A. & Segers, J., *Sustainable HRM. Bridging Theory and Practice through the Respect Openness Continuity – Model*. Paper presented at Workshop - Sustainability and Human Resource Management: Developing sustainable Business organizations, Université Catholique de Louvain (UCL), Louvain School of Management, 1348 Louvain-la-Neuve, Belgium, September 2013.
- [15] Cohen, E. , *CSR for HR: A necessary partnership for advancing responsible business practices*, Greenleaf Publishing, 2010.
- [16] ECM Europe. 2010. Risk Assessment in Ship Operations. [ONLINE] Available at: <http://www.ecmeurope.net/>. [Accessed 01 November 15].
- [17] Hunsaker, P., Tony, A., *The art of managing people*, 2nd Ed., New York, United States of America: Free Press, 1986.
- Guest, D.E. , "Human resource management and industrial relations", *Journal of Management Studies* 24(5), pp. 503–520, 1987.
- [18] Hunsaker, P., Tony, A., *The art of managing people*, 2nd Ed., New York, United States of America: Free Press, 1986
- Guest, D.E. , "Human resource management and industrial relations", *Journal of Management Studies* 24(5), pp. 521, 1987.
- [19] Turker, F., Deha Er, I., "Enhancing quality and safety management in shipping: tanker management and self assessment", *Lex ET Scientia Int'l J.* 15, pp.128 –134, 2008 Retrieved in Oil Companies International Marine Forum, *Tanker Management and Self Assessment (TMSA)*, Retrieved February 13, 2015 from: [www.ocimf.com](http://www.ocimf.com)
- [20] ] ECM Europe. 2010. Risk Assessment in Ship Operations. [ONLINE] Available at: <http://www.ecmeurope.net/>. [Accessed 01 November 15].
- [21] Liebowitz, J., "The Role of HR in achieving a sustainability Culture", *Journal of Sustainable Development*, 3: 4. , 2010.
- [22] Losey, M., Meisinger, S.R., Ulrich, D. , "Conclusion: reality, impact, and professionalism", *Human Resource Management*, 44, 2005, pp. 201–206.

## Towards a New World Economic Order

Sorin-George Toma

*Faculty of Administration and Business, University of Bucharest*  
[tomagsorin62@yahoo.com](mailto:tomagsorin62@yahoo.com)

Paul Marinescu

*Faculty of Administration and Business, University of Bucharest*  
[paulmarinescu1@gmail.com](mailto:paulmarinescu1@gmail.com)

Cosmin Ștefan

*CSOL-UB, University of Bucharest*  
[cosmins.faa@gmail.com](mailto:cosmins.faa@gmail.com)

### Abstract

*In the XIXth century, the British Empire dominated the world economy. In the last century, the United States of America (USA) became the economic superpower of the world. The US-led post-war world economic order had the following two strong pillars: the principle of fixed parities and US dollar standard and the principle of non-discrimination and free trade. Also, the Bretton Woods institutions clearly expressed the US post-war dominance of the world economic order. A new economic order is going to be set up in the world, dominated by Asia.*

*The paper aims at presenting an analysis of the old world economic order and the birth of a new order. Our methodological approach is based on a literature review.*

**Keywords:** world economic order, United States of America, gross domestic product, China

**J.E.L. Classification:** F02

### 1. Introduction

In the XIXth century, the British Empire dominated the world economy. Britain's economic success was the consequence of a sum of key elements such as the pursuit of economic efficiency, the advent of the First Industrial Revolution with its inventions that created the factory production, the expansion of markets, the division of labour, the mercantilist and imperialist policies of the state or the free trade.

A leading colonial and financial power [1], Britain created the first large engineering industry [2] in the world that highly contributed to its supremacy. In essence, there were four major components of the British superiority as follows: the United Kingdom herself, 'Greater India', its self-governing dominions, and its commercial empire [3]. This is why "the late nineteenth century international economy functioned as an integrated whole, with Britain at its heart" [4].

In the last century, the United States of America (USA) became the economic superpower of the world. At the end of the Second World War, the USA emerged as "the only major industrial power that had preserved its industrial plant intact", being able to "transform its absolute economic dominance into political primacy" [5]. The hegemony of the American economy was based on many factors such as its abundant resources (e.g., land, oil), the modern system of manufacturing, the widely use of leading-edge technologies, the rapid domestic capital accumulation, the expansion of corporations or the active economic role played by the state [6].

In 1974, the United Nations General Assembly adopted the Declaration on the Establishment of a New International Economic Order. The declaration promoted the establishment of a new economic order based on "equity, sovereign equality, interdependence, common interest and cooperation among all States, irrespective of their economic and social systems which shall correct inequalities and redress existing injustices, make it possible to eliminate the



widening gap between the developed and the developing countries and ensure steadily accelerating economic and social development and peace and justice for present and future generations" [7]. Since the 1970s, the world economy has witnessed several serious economic and financial crises which have had a negative impact, both on the developed and developing countries, due to their increasing vulnerability to external shocks in a globalised world.

The paper aims at presenting an analysis of the old world economic order and the birth of a new order. Our methodological approach is based on a literature review.

## 2. A new world economic order?

The US-led post-war world economic order had two strong pillars. The principle of fixed parities and US dollar standard represented the monetary pillar, and the commercial pillar was based on the principle of non-discrimination and free trade [8]. The Bretton Woods institutions (e.g., International Monetary Fund, General Agreement on Tariffs and Trade, World Bank) highly expressed the US post-war dominance of the world economic order [9]. The American order lasted until the beginning of the 1970s when President R. Nixon suspended the convertibility of US dollar.

In the period 1981-2001, several economic crises emerged in many European ex-communist countries and in countries of the Third World. On their turn, most of the Asian countries experienced a period of continuing fast economic growth. In the light of divergent trends across the world, "rapid and sustained expansion of the Chinese economy, and the more moderate, but consistent growth in India, were critical to the modest expansion of the world economy during the 1980s and 1990s" [10]. The developed countries of North America and Europe grew slowly, and Japan decelerated substantially. However, the USA preserved its world economic hegemony, being followed by Japan and Germany (Table 1, 2 and 3).

*Table 1. The world's ten largest economies after their GDP (nominal-current US\$) in 1981.*

No.	Country	GDP (\$ millions)
1.	USA	3,210,950
2.	Soviet Union	...
3.	Japan	1,201,465
4.	Germany	797,443
5.	France	617,589
6.	United Kingdom	540,765
7.	Italy	429,438
8.	Canada	305,748
9.	Brazil	263,561
10.	Mexico	250,083

Source: [11]

*Table 2. The world's ten largest economies after their GDP (nominal-current US\$) in 1991.*

No.	Country	GDP (\$ millions)
1.	USA	6,174,050
2.	Japan	3,536,800
3.	Germany	1,861,873
4.	France	1,275,563
5.	Italy	1,242,562
6.	United Kingdom	1,142,797
7.	Canada	608,258
8.	Spain	575,598
9.	Russian Federation	509,380
10.	Brazil	407,337

Source: [11]

*Table 3. The world's ten largest economies after their GDP (nominal-current US\$) in 2001.*

No.	Country	GDP (\$ millions)
1.	USA	10,621,824
2.	Japan	4,159,859
3.	Germany	1,947,928
4.	United Kingdom	1,529,094
5.	France	1,382,218
6.	China	1,332,239
7.	Italy	1,162,784
8.	Canada	732,716
9.	Mexico	724,703
10.	Spain	625,975

Source: [11]

Last year, the USA had still the biggest gross domestic product (GDP), followed by China and Japan (Table 4). However, China has already overtaken the US to become the

largest economy in purchasing power parity (PPP) terms in 2014 [12].

*Table 4. The world's ten largest economies after their GDP (nominal-current US\$) in 2014.*

No.	Country	GDP (\$ millions)
1.	USA	17,419,000
2.	China	10,360,105
3.	Japan	4,601,461
4.	Germany	3,852,556
5.	United Kingdom	2,941,886
6.	France	2,829,192
7.	Brazil	2,346,118
8.	Italy	2,144,338
9.	India	2,066,902
10.	Russian Federation	1,860,598

Source: [10]

Also, China has become a major player in the corporate world. In 2014, the top ten world's largest corporations after their revenues was dominated by the Chinese corporations (three corporations- Sinopec Group, China National Petroleum, State Grid), followed by the US corporations (two corporations- Wal-Mart, Exxon Mobil). The top was dominated by Wal-Mart (USA) with total revenues of 485,651 \$ millions. The second place was occupied by Sinopec Group (China) with total revenues of 446,811 \$ millions. On the other hand, the top ten world's most profitable corporations was dominated by the US corporations (five corporations- Apple, Exxon Mobil, Wells Fargo, Microsoft, JP Morgan Chase), followed by the Chinese corporations (four corporations- Industrial & Commercial Bank of China, China Construction Bank, Agricultural Bank of China, Bank of China). The top was dominated by Industrial & Commercial Bank of China with a profit of 44,763 \$ millions. The second place was occupied by Apple (USA) with a profit of 39,510 \$ millions [13].

In the first half of 2015, economic growth in advanced economies remained modest. Seven years after the world economy emerged from its worst postwar recession, "a return to robust and synchronized global expansion remains elusive" [14].

It seems that the global economic power shifts away "from the established advanced economies in North America, Western Europe and Japan will continue over the next 35 years" [15]. China will remain the largest economy in PPP terms in 2030 and 2050 (Table 5 and 6).

*Table 5. The world's ten largest economies after their GDP in PPP terms in 2030.*

No.	Country	Projected GDP at PPP (\$ billions)
1.	China	36,112
2.	USA	25,451
3.	India	17,138
4.	Japan	6,006
5.	Indonesia	5,486
6.	Brazil	4,996
7.	Russia	4,854
8.	Germany	4,590
9.	Mexico	3,985
10.	United Kingdom	3,586

Source: [15]

*Table 6. The world's ten largest economies after their GDP in PPP terms in 2050.*

No.	Country	Projected GDP at PPP (\$ billions)
1.	China	61,079
2.	India	42,205
3.	USA	41,384
4.	Indonesia	12,210
5.	Brazil	9,164
6.	Mexico	8,014
7.	Japan	7,914
8.	Russia	7,575
9.	Nigeria	7,345
10.	Germany	6,338

Source: [15]

There is no doubt that the world is witnessing the American economic decline. But, "if the United States is hardly the declining economic superpower portrayed in much of the literature today, it also continues to be able to do things that others can only dream of. In part, this is a function of its size; in part, a function of geographical luck (the United States possesses enormous quantities of oil, gas, coal and food) and in part, a function of its embedded position in the world economic system" [16].

The aforementioned discussion shows that

the US-led economic order is challenged more and more by other countries, especially from Asia. In fact, "Asia is going to carry on getting richer and stronger, probably for a long time to come" [17]. A new economic order is going to be set up in the world, dominated by Asia.

### 3. Conclusions

The world economic order has always been a highly debated topic in the literature. In the past centuries, the British Empire and the USA were the most powerful economic nations and, therefore, imposed their world economic order.

The economic expansion of the West constituted a remarkable feature of the post-war period. Asia's rise in the past decades, in general, and China's emergence as a strong and prosperous economic power, in particular, represent the main challenge for the old economic order.

Our paper has shown that the world is witnessing the birth of a new world economic order. It also provides a platform for further researches on this provocative economic subject.

### 4. References

- [1] Piketty, T., *Capital in the Twenty-First Century*, The Belknap Press of Harvard University Press, Cambridge, 2014.
- [2] Allen, R. C., "The British Industrial Revolution in Global Perspective: How Commerce Created the Industrial Revolution and Modern Economic Growth", Nuffield College, 2006, p. 29, <http://www.nuffield.ox.ac.uk/users/allen/unpublished/econinvent-3.pdf>.
- [3] Darwin, J., *The Empire Project: the Rise and Fall of the British World-System, 1830-1970*, Cambridge University Press, Cambridge, 2011.
- [4] O'Rourke, K. H., "From Empire to Europe: Britain in the World Economy", *Discussion Paper in Economic and Social History*, No. 106, October 2012, p. 15, University of Oxford, <http://www.nuff.ox.ac.uk/economics/history/Paper106/orourke106.pdf>.
- [5] Wallerstein, I., "The Curve of American Power", *New Left Review*, 40, July-August 2006, p. 78, <http://iwallerstein.com/wp-content/uploads/docs/NLRCURVE.PDF>.
- [6] Panitch, L., Gindin, S., *The Making of Global Capitalism*, Verso, London&New York, 2013.
- [7] United Nations, *Declaration on the Establishment of a New International Economic Order*, A/RES/S-6/3201, p. 1, 2229<sup>th</sup> plenary meeting, 1 May 1974, <http://www.un-documents.net/s6r3201.htm>.
- [8] de Montbrial, T., "For a New World Economic Order", *Foreign Affairs*, 54, October 1975, pp. 61-78, <https://www.foreignaffairs.com/articles/1975-10-01/new-world-economic-order>.
- [9] Beeson, M., "The Rise of the 'Neocons' and the Evolution of American Foreign Policy", *Asia Research Centre Working Paper*, No. 107, August 2004, Murdoch University, pp. 1-22, [http://www.murdoch.edu.au/Research-capabilities/Asia-Research-Centre/\\_document/working-papers/wp107.pdf](http://www.murdoch.edu.au/Research-capabilities/Asia-Research-Centre/_document/working-papers/wp107.pdf).
- [10] Berry, A., Serieux, J., "Riding the Elephants: The Evolution of World Economic Growth and Income Distribution at the End of the Twentieth Century (1980-2000)", *DESA Working Paper*, No. 27, September 2006, p. 21, [http://www.un.org/esa/desa/papers/2006/wp27\\_2006.pdf](http://www.un.org/esa/desa/papers/2006/wp27_2006.pdf).
- [11] The World Bank (WB), *Data- GDP (current US \$)*, <http://data.worldbank.org/indicator/NY.GDP.MKTP.CD?page=6>.
- [12] International Monetary Fund (IMF), "People's Republic of China: 2015 IV Consultation", *IMF Country Report No. 15/234*, August 2015, <http://www.imf.org/external/pubs/ft/scr/2015/cr15234.pdf>.
- [13] Fortune, *Fortune Global 500*, <http://fortune.com/global500/>.
- [14] International Monetary Fund, *World Economic Outlook: Adjusting to Lower Commodities Prices*, October 2015, p. xiii, <http://www.imf.org/external/pubs/ft/weo/2015/02/pdf/text.pdf>.
- [15] PricewaterhouseCoopers (PwC), *The World in 2050- Will the shift in global economic power continue?*, February 2015, p. 1, <https://www.pwc.com/gx/en/issues/the-economy/assets/world-in-2050-february-2015.pdf>.
- [16] Cox, M., "Power Shifts, Economic Change and the Decline of the West", *International Relations*, 26(4), 2012, p. 374, <http://www.lse.ac.uk/IDEAS/pdf/Cox-Waltz.pdf>.
- [17] Emmott, B., *Rivals: How the Power Struggle between China, India and Japan Will Shape Our Next Decade*, Penguin Books, London, 2009, p. 8.

**Section I**  
**International Affairs and European Integration**

\*\*\*

**Subsection 2**  
**European Integration**

## Power Public - Economic Stake of Romanian Tourism

Constanta Enea

Constantin Enea

„Constantin Brancusi” University of Targu-Jiu, Economics Faculty

[constantina\\_enea@yahoo.com](mailto:constantina_enea@yahoo.com)

### Abstract

*The economic challenge of international tourism makes public power to intervene increasingly on economic mechanisms of the tourism market to benefit from direct and indirect effects of tourist arrivals. Public aid in financing tourism investments has, in these circumstances, paramount to enable the tourism sector to play a leading role in the economy. The assistance that the public authorities can give tourism activities take various forms, ranging from actively promoting the country's image, to taxing Tourist operations.*

*This paper highlights strictly business accommodation and catering of tourism, where it finds that an offer of tourist resources diversified into a space balanced natural riches value steadily increasing in an environment quite polluted and big problems green.*

**Key words:** tourism, public power, appropriate public policies, investments, quality-even point.

**J.E.L. classification:** M 21

### 1. Introduction

Mobilization of all local resources and those responsible for tourism promotion, will generate local community development with implications even national economic recovery.

The tourism industry is labor, and at the same time, heavy industry. Or, should we find that very often investment in the tourism sector efforts were not sufficient (any many regions in France, Spain, Italy, the Greek islands, etc.), resulting in premature aging housing units, hotels and more, possible measures and rehabilitation and renovation is nearly impossible[1].

This makes hotel owners decrease their quality to remain competitive benefits. Improving infrastructure quality accommodation and catering involves establishing an active policy of public power (state, regions and local authorities) to[2]:

- Encouraging investment quality both in terms of construction and in terms of cultural content urbanism projects;
- Promoting training on all factors of tourism;
- Establishing suitable financial montages.

The economic challenge of international and domestic tourism makes public power to intervene increasingly on economic mechanisms of the tourism market to benefit from direct and indirect effects of the arrival of tourists.

### 2. Rational policy of public power applied locally, queens and national level.

The fact that tourism is by definition located at the confluence of most economic and social field and with real dependence to some of them (industry in general and food in particular, agriculture, transport, public services), requires the development of tourism sector not only part of the plan of socio - economic development of Romania, it represents even drive the development of all economic activity.

The strategic goals should follow rapid and lasting revival, paying special attention to the place of tourism in the national economy, so that it becomes a priority sector by concerted action of legislative bodies, governmental and local government.

They are strictly related to government objectives, but many relate directly to local public authorities of the country's counties and businesses specializing in tourism.

Hence the need to involve local authorities

and the county development strategy in the medium and promote tourism activities in the broader context of globalization and our country's integration into the European Union.

It should also be said that a strategy seeks to develop and promote tourism activities, mandatory register as a distinct point in a broader context, we call on local and regional development.

Both reality "European" and the Romanian shows that local / regional development is directly conditional on the implementation of projects of local interest, administered locally by individuals, entrepreneurs, local / regional know best the problems and possibilities. On the other hand, without the direct involvement and without the support of local authorities, it is hard to talk about local development.

Finally, a plan remains only a theoretical scheme if not based on real objectives, accepted as such and promoted by factors influencers if not using resources available locally and if the effort and the results are not known recognized at different levels and target groups concerned. The management of these projects at a level as "local" enables engagement and accountability, incentives lead to a larger number of potential beneficiaries and promotes well-being from within the community. In addition, a successful locally generate confidence and interest of investors from outside and an area in full "boom" becomes economically attractive to more and more favorable to the development activities.

Referring only to the activity of accommodation and catering of tourism, revealed a diversified offer of tourist resources in a balanced natural space, a constant value increasing wealth in an environment quite polluted and major environmental problems.

The concentration of joint efforts of the state and economic agents of tourism in exploiting these resources is not only a sound policy, but also a convenient and secure way of progress because tourism is[3]:

- Generator of foreign currency, receipts from international tourism through;
- Creator of jobs, with positive effect partial absorption of the workforce laid off in other sectors;
- Creator of connections between the

various branches and sectors of the economy;

- Dynamic factor in the process of increasing the quality of life;
- And creator of the image carrier in the world.

In these circumstances the state's role is to implement the economic policy which directly and indirectly affect tourism, namely the cost of benefits, wage policy, price policy and credit policy. In parallel, selective tax policy often has a very specific purpose, which directly and specifically the tourism sector[4].

Public aid in financing tourism investments has, in these circumstances, paramount to enable the tourism sector to play an active role in the economy.

The assistance that the public authorities can give tourism activities take various forms, ranging from actively promoting the country's image to Tourist taxed transactions.

Although tourism sector is generally considered as belonging predominantly private initiative, tourism development is increasingly accompanied by increasing coordination between power politics and public investment in the professional sector. Indeed, even with the constraints acting on the tourism sector (labor cost, cost of operation of investment property), the projects that interested investors must produce revenue sufficient, which implies the need to leave the functions of the public financing of basic infrastructure and tourism planning. We must not neglect the fact that the problem of inequality between developed countries and emerging tourism development is likely to worsen in the future.

Given the particularities practiced by the companies, it is necessary to move from short-term and intensive use of existing infrastructure, a widely used, spaced throughout the calendar year. This would improve the degree of exploitation of infrastructure and more efficient use of the accommodation. This recovery operation, the accommodation during the full season and the season ends recorded an increase in tourist traffic. But the growth of tourist traffic and changes in its structure are accompanied by corresponding development of infrastructure.

Also, the development of the catering facilities, modernization and diversification,

the increasing quality of serving some of the coordinates are added to attract potential tourists.

Grade increasingly higher preferences for higher quality tourists tourism leads us to harness the full potential maximum area exploitations, to put into practice all the strategies they know and can satisfy the claims of all Romanian and foreign tourists [5]. If we take into consideration the competitiveness of European tourism in the world or when we need to make efforts to offer tourists everything is newer, nicer and more attractive, to determine to choose resort spa area explored; to attract tourists even that segment income, and hence, higher expectations, in other words, to be competitive.

The power of attraction of tourists to a particular area or state depends on the variety and quality of tourism services provided, and differentiation occurred at rates, leading to a prolongation of the tourism season and further tourism development. But besides all this, the natural factors and the entire cultural heritage contribute greatly to attracting the customer, to be maintained and developed further. Increasing the attractiveness of landmarks can be increased, taking into account modern forms and diversified spa treatment, conditions and natural factors specific to the hills and mountains, the increase of the range recreation, to satisfy the tastes and preferences of both Romanian tourists and sneezing.

All resorts should provide favorable conditions, quality and quantity of spending stays. The offer is more diversified tourism services, the risk of losing customers decreases. For it must diversify and modernize tourism infrastructure.

There are numerous objectives that can be built and that could lead to an increase in actions recreation: the construction of new hotels equipped with high technology, new restaurants, in places as attractive (restaurant on a crag) database modern leisure rooms and equipped with the latest equipment, outdoor pools and covered, select clubs, pubs for young tourists, cultural and educational centers etc.

Also to be found, promoted and capitalized our area specific forms, traditions and popular art that would capture the attention of potential tourists.

It is necessary to take into account the motivations and tourist options to be exploited to the full.

Another parameter to be pursued for the development of tourism, taking into account that the working week is 5 days, and people from 2 to 2.5 days off, is attracting people from all areas, but especially in the surroundings of the stations in areas recreation and leisure, and why not for treatment [6].

The tourism potential must be processed so as to be suitable for all types of tourists, but also to all age segments. For a family stay to produce the desired expectations, it is useful to consider the construction of spaces for play and supervision of children. The tourist offer and it must diversify so that tourists can choose what is convenient for them. Necessary facilities should be based on the physical and mental condition and age of tourists. Follow achieve a higher quality of products and tourist infrastructure shall not cause a decrease in competitiveness. For this, productivity growth is essential tourism businesses. These productivity gains are possible, they depend on the introduction of new technologies. This is the case of accommodation with implantation of new chains of 2 and 3 star hotels. Also, productivity gains, thanks to a structural design adapted and introduction of new technologies, namely reception, catering and payment, significantly reduce the need for labor (the thresholds for a hotel of 40 rooms has been reduced from 20 people at more than 10 and even less than 5 star hotels)[7].

### **3. Conclusions**

The future of the country depends heavily on tourism policy of diversification of tourism products. Indeed, if it is undeniable that health tourism remains the foundation of tourist frequency, we are forced to acknowledge that in many regions the threshold of maximum saturation have been overcome and that any new development in the number of tourists should focus priority on other areas tourism planning[8]. Therefore an active policy not only creating new tourism products, but also new sales channels is essential.

Dies tourism development of a truly

requires that products travel downstream to present comparative advantages in terms of competitive and price - quality ratio. Two main objectives are particularly important to allow countries to retain and perhaps to increase participation in tourism: quality and productivity [8]. Through these discussions I tried to emphasize the importance of extending operation under normal conditions, infrastructure companies; attracting a greater number of tourists, achieve the highest possible efficiency of the entire tourism potential. The advice which could be given to achieve this greater efficiency is high quality with as little effort and in a short time, which can be achieved by using modern technologies. It should be noted that tourism has the cognitive component, responding to man's desire to know as much as possible.

All tourist services related to the economy.

Efficiency promotional consists of image spots and a form of tourism offer, after staying in the country, image, along with all other impression gained, can compete to form a general opinion favorable opinion which communicated the country of residence, can have an effective promotional effect [9].

For the most part, the assessment of economic efficiency in tourism criteria are taken into account both economic and social criteria, and each tourist establishment must cover own revenues and benefit bigger. This gives a ratio between the efforts made and the effects achieved.

Infrastructure development is a key aspect of tourism development, growth's contribution to the overall development of the national economy and raising the material and spiritual standard of the population.

The economic challenge of international tourism makes public power to intervene increasingly on economic mechanisms of the tourism market to benefit from direct and indirect effects of tourist arrivals. Public aid in financing tourism investments has, in these circumstances, paramount to enable the tourism sector to play a leading role in the economy [10]. The assistance that the public authorities can give tourism activities take various forms, ranging from actively promoting the country's image, to taxing Tourist operations.

In these circumstances, the role of

member governments is to implement the economic policy which directly influence and indirect costs, namely tourism benefits, wage policy, price policy and credit policy. It is essential that political tourism to be accepted as a priority, without compromising durability or tourist programs based on sustainable development principles can not be implemented successfully.

In the current context of sustainable development, tourism finds its natural place, bringing to the fore the idea of satisfying the needs of tourists and the tourist industry, closely linked to environmental protection and future opportunities.

We believe that careful consideration, theoretically, these problems allows shaping of research directions and finally, draw conclusions, possible solutions.

#### 4. References

- [1] Gh. Postelnicu, *Introduction to the Theory and Practice of Tourism*, Ed. Dacia, 1997
- [2] D. Abaza, Stremtan F., A. Ispas, I. Abaza, *Tourism marketing elements*, Ed. Global Media Image, Deva 2000
- [3] M. Candia G. Erdeli, D. Peptenatu, T. Simon, *Romania's tourism potential and tourism arrangement of space*, Ed. University, Bucharest, 2003
- [4] I. Berbecaru, *Tourism promotional strategy*, Ed. Sport-Tourism, Bucharest, 1976
- [5] B. Garcia Henche, *Marketing in rural tourism*, Irecson Publishing House, Bucharest 2004
- [6] D. Cowell, *The Marketing of Services*, Heinemann, London, 1984
- [7] W. Ugeux, *Les relations publiques*, Ed. Gerard & Co, Vernieres 2005
- [8] I. Berbecaru, *Tourism promotional strategy*, Ed. Sport-Tourism, Bucharest, 1976
- [9] <http://www.ilierotariu.ro/documents/books/globalizare%20si%20turism.pdf>
- [10] <http://www.postdoctorat.ro/Documente/Biblioteca%20virtuala/Rezumat%20teze%20de%20doctorat/Seria%20I/NICULA%20Virgil/Nicula%20Virgil%20-%20seria%201%20Sibiu%20-%20rezumatul%20tezei%20de%20doctorat.doc>



## Romania's EU Advantages Integration

Constanta Enea

Constantin Enea

„Constantin Brancusi” University of Targu-Jiu, Economics Faculty

[constantina\\_enea@yahoo.com](mailto:constantina_enea@yahoo.com)

### Abstract

*The issue of accession to the European Union is very extensive if we consider originality of historiography approaches romanian.*

*With a tortuous path and numerous tests to which it was subjected today would be talking about a Romania aligned with European standards model for countries for countries aspiring to join it. In the following lines, we make a retrospective of remarkable moments in which Romania's accession to the European Union.*

*The present paper makes an incursion benefits our country's accession to the EU since 2000 until now.*

**Key words:** transitions, integration economic, relations economic, national interest.

**J.E.L. classification:** F 63

### 1. Introduction

1993 Romania signed the Association Agreement with the EU and in 1995 acquired the status of EU associate state. Thus the European Union, interested itself in the extension of integration, supports Romania, relatively young democratic country, through assistance, advice and financing projects that correspond to European standards.

The objective is that all areas that our country have a similar level of development to no more regional imbalances, so the standard of living in our country would rise. That does not mean that the Romanians will feel the difference for the better once Romania joins the EU.

The integrating processes and the globalization of the national economies do not represent a purpose in itself, but the way to satisfy the national interests in the

conditions created after the Second World War.

Globalization is a result of a post/war process of amplification and diversification of the interdependencies between national economies [1]. This tendency got shaped based on the deepening of labor division on world level, on the evaluation of the increasing possibilities offered by the contemporary scientific and technical revolution: new means of IT and automatics, new forms of energy, new materials and technologies. The modern market economies evaluated increasingly new directions of the scientific and technical advance with new forms of international specialization. On this basis numerous American firms, many West European companies and the main Japanese firms extended into transnational companies, within and through Common wealth (the present day EU) and into the action of “localization” of their branches into various countries[1]. The external economic relations of most countries of the world have been polarized to the three main forms of economic integration leading to the present day globalization. Within each main form of economic integration the national interests of the initiating countries are satisfied: the economic interests of US are predominant in the transnational companies; the economic interests of main Western countries determined the foundation and the evolution of the Common wealth that became EU; the economic interests of Japan directed the “localization” of many branches of the large Japanese companies in the Pacific area [1].

### 2. EU - the most advanced form of economic integration and global transformation of national economies

The integrating processes and the globalization of the national economies do not represent a purpose in itself, but the way

to satisfy the national interests in the conditions created after the Second World War. Within each main form of economic integration the national interests of the initiating countries are satisfied [2]: the economic interests of US are predominant in the transnational companies; the economic interests of main Western countries determined the foundation and the evolution of the Common wealth that became EU; the economic interests of Japan directed the "localization" of many branches of the large Japanese companies in the Pacific area.

The economic integration by creating new interstate organizations supposed a certain harmonization of the economic interests of the participating countries.

Common wealth was founded based on the acceptance of some common features for the national interests of those countries.

Therefore, the West European economic integration is basically a manner of satisfying the national interests of the participating countries, both within the reciprocal economic relations and within the economic relations with tertiary countries.

The countries promoting the economic integration on the European level sacrificed in no way their national interests for the cause of integration [3]. This fundamental requirement should be also satisfied by the ex-socialist countries that are on their way to adhering to EU.

However, during the integrating processes parallel with the harmonization of certain economic interests of the participating countries, important differences of interests between those countries continue to manifest themselves. This double tendency regarding national interests is also obvious for the present day evolution of EU [1]. On one hand, in order to assure the harmonization of certain national interests of the participating countries without touching their sovereignty, EU should maintain its feature of an interstate organization. Especially Great Britain supports this perspective. On the other hand, in order to make the distinction between the interests of the participating countries they consider that EU ought to become a federative state, a fact that would considerably limit the sovereignty of the participating countries. Germany manifested the largest interest for possible that the adherence of new states to EU should be

accompanied by a lessening chance to harmonize certain interests of the countries participating at European integration, in parallel with an increasing risk due to certain differences between those countries' interests.

EU is the most advanced form of economic integration and global transformation of national economies.

In spite of this fact, national interests go on manifesting themselves strongly within both this organization and the relations between the member countries and the ones outside it.

It is obvious that the prime feature of national interests has an objective basis within the contemporary international economic relations, with, should be attentively taken into consideration. This basis is in fact that national economies continue to be the basic cells of the world economy with a strong vitality.

Ours specialists underlines that the national economy, as the economy of the most durable and structured human, territorial, linguistic, cultural, historical and spiritual community holds the most important place in the global system. That is why within the international economic relations the national economic interests of the participating countries, especially the best developed ones continue to be on a prime level. Consequently, as long as mankind consists of nations, national states and economies an adequate correlation and satisfaction of their national interests largely condition the peaceful and fruitful living of the peoples.

In each country citizens have various economic needs and - as a conscious expression - economic interests. Through evaluating the possibilities offered by the contemporary scientific and technical revolution, the variety of people' economic needs and interests is not diminished but it is deepened. Parallel with this tendency, the diversity of citizens' economic interests in each country shows certain common elements generated by those citizens' belonging to a nation, to a national state and to a national economy. Therefore, the national economic interests are the actual common features for the total economic interests of the citizens of a country.

### 3. Conclusions

In our country they often invoke the necessity to take into account the "national economic interests". Would it be possible that the total economic interests of the citizens in one country be synthesized into only one national economic interest?

Certainly not. However, using certain criteria a system of national economic interests could be rigorously shaped. Starting from this premise Romania's national economic interests could be defined according to at least two main criteria [3]. On one hand, the economic interests of the citizens can be synthesized into certain common features in relation to the object of these interests. From the above-mentioned standpoint several main categories of national economic interests can be drawn [3].

In the first place, it refers to the interest regarding the increasing and efficient use of labor resources. These resources can not be preserved and not using a part of them result in large damages for many citizens and for the whole society. That is why, limiting as much as possible the unemployment and increasingly and efficiently using the labor force represent a fundamental economic interest for all present day Romanian citizens.

In the second place, the national economic interests refer to the use of the natural resources available in our country.

Taking into account the fact that these resources are limited and the underground resources are exhaustible it results that the rational use of all available natural resources in the context of a viable economic development represents an economic interests vital for both present day and future generations.

In the third place, the national economic interests refer to the use the technical and material resources accumulated in the Romanian economy especially on the basis of the considerable investment effort made during the socialist period.

The adequate use of the production and research available capacities corresponds to the interests of about all present day citizens of Romania. It would assure an increasing utilization of the labor force, the increase of production and incomes and on this basis the living standard of the general population could be ameliorated.

In the fourth place, the national economic interests regard the adequate functioning of the monetary system so that it is able to assure a normal functioning of consumption saving and investment processes.

In this respect, in our country it is necessary to put an end to inflation and to gradually increase the purchase power of the leu since this evolution would favorably influence the satisfaction of most citizens' interests.

In the fifth place, the national economic interests refer to the development and consolidation of the national economic complex based on some coherent and modern territorial and branch structures. After the lack of organization and decline during the 1990-2014 satisfying the interests of all citizens the rehabilitation of modern agriculture, the re-industrialization and a sustained increase of services correlated with a balanced development of the countries and localities are necessary.

In the sixth place, the national economic interests regard the adequate evolution of our country's external economic relations. The involution that occurred in these relation during the post-socialist period reveals influenced by a favorable trade balance and balance of payments. At the same time, it is influenced by stopping the deterioration of the leu's currency exchange, through a gradual amelioration of our country's place in the world economic circuit. These changes would permit that Romania's participation at the international economic relations should contribute to the increase of our country's GNP.

On the other hand, the national economic interests in present day Romania can be defined in relation with the subjects of these interests. According to this criterion, two main categories of national economic interests can be drawn.

One category is represented by citizens' private economic interests aiming at a normal achievement of the attributes given to each citizen by the private property. According to the manner of utilization of the private property object one may distinguish individual, family and economic interests of the associates in various enterprises. In the present day Romanian economy the privatization leads to the extension of private economic interests and the increase of their

weight within the total national economic interests. However, among the national economic interests not all the interests of the citizens linked to the private property can be included, but only that common feature (rights to each responsibilities) which is assured by the private property to each citizen. Consequently, the actual tendency to satisfy the private interests of some citizens to the detriment of other private interests of other citizens can not be included into the sphere of national economic interests, but it represents just an opposite manifestation of the normal evolution of these interests[5].

Another category of national economic interests consists of public interests among which the citizens' interests are given by the public power through the utilization of the public property object.

The citizens' general economic interests (in enterprises and institutions subordinated to the inter-countries bodies of the public power) and local economic interests of the public power in communes and towns are included into the category of public interests [6]. During the present day transition the change of the relation between the private and the public sectors determines a weight reduction of the public interests for the total economic interests. At the same time, through the enforcement of the state of law restructuring of the public sector would be assured, so that it becomes able to satisfy the citizens' needs at an increasing level and no discriminations. Consequently, in the sphere of the national economic interests, the public, local and central interests as a bio-psycho-social being should be included. However, in our country the activity of many segments of the public sector does not meet this fundamental criterion.

Among the categories of national economic interests defined according to the two main criteria (regarding the subject and object of interests) there are numerous links and a close interdependence is achieved. Consequently, in today's Romania there is a system of national interests in which certain interests reciprocally sustain and others are in opposition.

That is why the rigorous determination of the national economic interests and their adequate correlation might contribute substantially to the rehabilitation of Romania

economy and its increasing assertion in Europe and the whole world.

According to the European Economic Forecast 2015 in Romania, GDP rose 2.4%, the inflation rate will reach 2.1% and unemployment at 6.9%. Overall in the EU, the European Commission forecasts indicate low economic growth both in the EU and in the euro area [7]:

- For 2014 as a whole, real GDP growth reached 1.3% in the EU and 0.8% in the euro area.

- The increase resulted in a slight acceleration in the course of 2015, reaching 1.5% and 1.1%, amid improved external and domestic demand.

- In 2016, expect an intensification of economic activity to 2.0% and 1.7% due to strengthening the financial sector and due to recent structural reforms that are bearing fruit.

Economic recovery started in the second quarter of 2013 is still fragile, and economic recovery is still weak in many Member States[4].

Confidence is at a lower level than in the spring, reflecting the increasingly important geopolitical risks and less favorable economic prospects available worldwide. Despite favorable financial conditions, economic recovery in 2015 is quite slow. However, it is expected that within two years the differences between the growth rates will be reduced. In 2015 and 2016, it is estimated that all EU countries will record positive growth, the effect being felt already implemented reforms to a greater extent. Since the process is gradual growth dynamics to know increasingly important towards the end of the forecast period should occur more consistent improvements in the labor market. For Romania expects a drop in unemployment, from 7% in 2014 to 6.9% in 2015 and 6.7% in 2016 [7].

In the European Union the pace of creating jobs has been moderate and unemployment rates decreased slightly from elevated levels. In 2016, the unemployment rate would fall to 9.5% in the EU and 10.8% in the euro area[7]. The trend towards lower inflation continued in 2014 in EU Member States, due to lower commodity prices and a significant economic slowdown. Inflation remained very low in 2014. As economic activity is gradually increasing and there is an

increase in wages, inflation will probably know a growing phenomenon contributing to the recent depreciation of the euro[7]. In Romania, the HICP (harmonized index of consumer prices) is estimated at 1.5% this year and 2.1% in 2015 and 2.7% in 2016 [7]. In the EU, inflation was 0.6% in 2014, 1.0% in 2015 and 1.6% in 2016. Euro area inflation estimated at 0.5% this year and 0.8% 2015 after increasing to 1.5% in 2016 [7].

However remain risks to the economic outlook. We refer to the risks to the growth outlook continues to dominate amid geopolitical tensions, instability of financial markets and the possibility that the structural reforms be implemented incompletely.

Romania's EU enlargement brings serious benefits:

- it will be supported in the transition to democracy and market economy, aiming at respecting human rights, the rule of law, political pluralism and separation of powers;
- will benefit from advanced technologies to modernize industry and agriculture, the introduction of modern management;
- EU Internal market penetration enables increased productivity and living standards of the Romans;
- the prospect of EU internal market an obligation to create mechanisms functioning market, a competitive economy, able to withstand the competitive pressures of Western products and services;
- It is guaranteed the independence and sovereignty, its participation -in the PESC- address some important contemporary world.

Accession to the European Union is not without costs to any alliance is based mostly on economic - financial aspects, but EU integration is impossible without additional costs incurred by both parties [8].

But the new institutional framework of EU structural reforms carried out in the country's politics, can lead to substantial reduction of overall costs and more a downward trend over time for EU countries, as Romania will be able to collect the costs respective.

Certain that EU membership costs. But that would not accede it cost? Non-adherence

would actually pushing towards underdevelopment.

Therefore, the benefits of accession are much greater than the costs. Romania's integration into EU structures shows more advantages than disadvantages.

Romania will join in a market in which goods can move freely, and we as a people will be able to travel to any country and we have access to all areas, which until now did not have access, for various reasons; Romania's economic potential will grow because the EU will bring foreign investors, who will know how to exploit the potential that we have, but not knowing how to capitalize.

Perhaps, most important advantages, which brought Romania's EU integration are Romanian citizens the rights they have acquired.

From January 1 2007 the Romanians have the same rights as any citizen of the European Union.

These rights, which guarantee us European Social Charter: the right to practice any profession in one of the European Community countries of their choice; right to fair remuneration; right to improve living and working conditions; right to social protection provided by the system in force in the host country; the right to freedom of association and collective bargaining; right to vocational training; the right to equal treatment between men and women; the right to information, consultation and participation of employees; right to health protection and job security; diplomatic and consular protection from another Member State; the right to protection of children and adolescents; guaranteeing a minimum income for the elderly; right to professional and social integration for people with disabilities. Are these drawbacks of integration? EU integration is an advantage for Romania because it guarantees additional stability and bring added safety in this part of Europe in a world increasingly marked by danger. Also Romanian citizens will have more confidence in themselves, which will be good for the transformation of society in all European plan. Unions has a completely different rhythm, intensity and discipline of work, we hope to help us better organize.

Historic opportunity to modernize Romania's joining the EU should be judged by and through the benefit of belonging to a

large family of nations who will help and support each other. EU system integrates us in the whole of Europe is concerned not disrupt flows on the border with Romania. Regarding the labor market in Romania, which covers job applications from young graduates waves, the EU will solve this problem: create new jobs in all areas. For example, many qualified IT specialists are employed by companies in Germany and other countries, and many young men and women in Romania ensure services currently functioning in some hospitals, hotels and restaurants in Italy and Portugal etc. Moreover, Romania has become a big exporter of skilled labor and less qualified in recent years and will continue to do so.

In such a new Europe rooted in the depths of history, Romania is by its history, the present, or in the same European family.

#### 4. References

- [1] Vasile Nechita - In his paper "Integrarea Europeana", Ed. Desteptarea, Bacau, 1997;
- [2] Jurnal "Tribuna Economica", Collection, 2000- 2015;
- [3] Quotidian "Economistul", Collection, 2000-2015
- [4][http://beta.ier.ro/documente/studiideimpactPaisII\\_ro/Pais2\\_studiu\\_12\\_ro.pdf](http://beta.ier.ro/documente/studiideimpactPaisII_ro/Pais2_studiu_12_ro.pdf)
- [5] Baldwin, Richard and Charles Wyplosz, The Economics of European Integration, 2000, <http://heiwww.unige.ch/~baldwin/papers.htm>
- [6] Ciupagea et al., Impactul Uniunii Europene asupra României. Abordări teoreticometodologice privind costurile și beneficiile integrării României în Uniunea Europeană, studiu CERES, 2003.
- [7] <http://www.europedirect-adrcentru.ro/index.php/stiri-uniunea-europeana/381-care-sunt-previziunile-economice-pentru-romania-si-uniunea-europeana>, 2014
- [8] <http://eurojust.ro/retrospectiva-aderarii-romaniei-la-uniunea-europeana/>

## Does Youth Migration for Education Have an Impact on Permanent Migration Decision? Case Study on Bessarabian Students in Romania

Simona Ghita

*Academy of Economic Studies in Bucharest - Department of Statistics and Econometrics*  
[simona.ghita@csie.ase.ro](mailto:simona.ghita@csie.ase.ro)

Cristina Boboc

*Academy of Economic Studies in Bucharest - Department of Statistics and Econometrics*  
[cristina.boboc@csie.ase.ro](mailto:cristina.boboc@csie.ase.ro)

Daniela Manea

*Academy of Economic Studies in Bucharest - Department of Statistics and Econometrics*  
[daniela.todose@csie.ase.ro](mailto:daniela.todose@csie.ase.ro)

### Abstract

*The problem of youth migration for education in Moldova existed during and after the Soviet period. Since 1991, many young Bessarabians decided to study in Romania for various reasons [1].*

*The present paper reveals the results of a survey on Moldovan students from three universities in Bucharest: Bucharest Academy of Economic Studies, University "Politehnica" of Bucharest, and the University of Bucharest. 65.1% of the students surveyed were influenced in their decision to study in Bucharest by the prestige of Romanian university centers, 86.55% believe that getting a bachelor's degree in Romania helps them to find a job easier in an EU country; 50% of students are interested in attending Master courses in Romania while 29% of them want to continue working in Romania, 50% - in another country (preferably in an EU country) and only 21% intend to return to Moldova.*

**Key words:** migration, youth migration for education, survey

**J.E.L. classification:** C83, I23, J61, O15.

### 1. Introduction. The dimension of migration phenomenon in Republic of Moldova.

In the context of globalization, international migration of young people acquires new meanings and dimensions, playing an important role in working age

population growth in developed countries. From the perspective of many developed countries, especially in Europe, which is facing the aging problem, migration can affect the structure of young population, its role of ensuring economic development and supporting the social security system [2] [3]. In the past thirty years the number of students who are enrolled in tertiary education outside their country of origin rose approximately 5.4 times, from 0.8 million in 1975 to 4.3 million in 2011, worldwide. The growth has deepened in the last decade, during which the number of foreign students has doubled. Most foreign students are in Australia, United Kingdom, Switzerland, New Zealand and Austria. Asian students represent over 50% of all foreign students worldwide and are mainly from China, India and Korea. Europe is in the top destinations for foreign students (48%), followed by North America (21%) [4]. This phenomenon was favored by the opportunity offered by many countries to allow foreign students to work there for a period after graduation, or to be "part-time" employed while studying. Thus, in many cases, migration for education turned to highly qualified labor migration ("brain drain") [5].

This paper focuses on the migration phenomenon in Moldova. Migration issue has got a greater importance in Moldova during its development period as an independent state, although Moldova was affected by higher rates of emigration even in Soviet times. In recent years, Moldovan economy suffered major transformations, characterized by the development of the

private sector, closing large state companies - which ensured a large part of the job supply. These changes were accompanied by occurrence and intensification of unemployment, which has led to an exacerbation, widening external migration of population (Youth unemployment rose in the first quarter of 2012 to 16.1% - [6] [7]). The disadvantages of such phenomenon on the Moldovan economy prevail, compared to the advantages they could bring in. Thus, one advantage is the remittances that - in 2008 - amounted to USD 1.8 billion, representing about 30% of GDP [8] [9]. Virtually, every third Moldovan household receives remittances and for every second household the remittances from abroad account for more than half of their total income.

According to the National Bureau of Statistics, men dominate the group of migrants, representing about 67.6% in 2012 [9]. The economic crisis has negatively affected youth unemployment. In the first quarter of 2012, unemployment among young people (aged 15-24) reached 16.1%. But in the next two years it has decreased to 14.5% in 2013 and to 10.3% in 2014 [6].

## 2. Methodology. Data set

Data requested for studies characterizing the migration phenomenon among Moldavians were obtained by organizing a survey on students from Bessarabia, who experience the educational process in Romania, in three academic universities of Bucharest: Bucharest Academy of Economic Studies, University of Bucharest and University „POLITEHNICA” of Bucharest. The questionnaire and data collection were performed by Doina Girbu as part of a study in the bachelor program. The survey aimed at the following objectives: analyzing the motivational factors that caused educational migration, analyzing the factors that facilitate or discourage the returning to Moldova, students' evaluation on the advantages of staying in Romania compared to expectations raised by studies attended in our country. It has been applied a random stratified sampling plan, the stratification criteria being the university and the selection units in each stratum was done by simple random process without replacement [10] [11]. The sample size was equal to 238 Bessarabian students,

corresponding to an error within  $\pm 3\%$  and a 95% confidence level. The data was collected through e-mail and took place from December 8 to 27, 2014. Data were entered and processed using statistical procedures included in the software package SPSS.

The questionnaire contains 19 questions aimed at three sequences: • Factors that influence the Bessarabian students' decision to migrate for studies in Romania; • Educational experience gained and Bessarabian students' status in Romania; • Intentions for future careers.

## 3. Survey results analysis

### 3.1. Emphasizing the factors determining the orientation towards migration

Almost one third of students consider that the opportunity to leave the country had a major influence in choosing to graduate in Romania and 26.8% of them were attracted by the facilities that the Romanian state offers to Bessarabian students (grants, places in students' houses, a sufficient number of places in universities, etc) (Figure 1). Students from University of Bucharest were motivated to a greater extent in the migration decision to study in Romania by the facilities offered by the Romanian state (41.8%).

Figure 1. Question 2: What influenced your choice of studying in Romania?

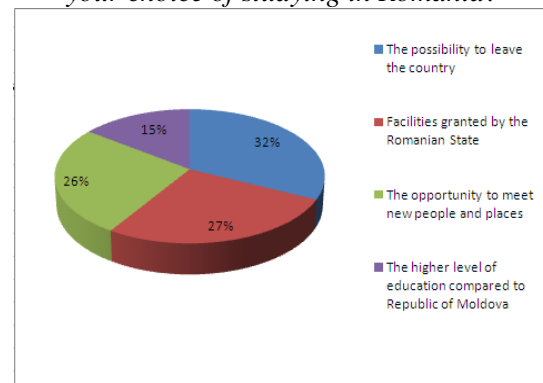

Source: authors' processing, based on survey data.

Almost 65% of students surveyed believe that the number of places in universities, provided for the Bessarabian students was enough (Figure 2). Of these, nearly 70% were males. Qualification in Romania offers a chance to find a job in the European Union.



At least 84.07% and at most 89.04% of the students surveyed have this opinion.

Figure 2. Question 5: How do you find the number of university places available for the Bessarabian students?

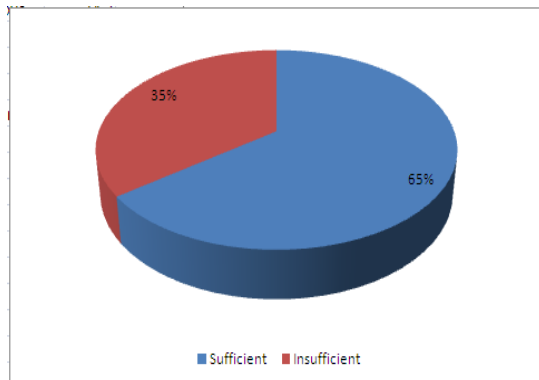

Source: authors' processing, based on survey data.

### 3.2. Evaluation of educational experience and Bessarabian students' adapting to their new status

Once in Romania, for Bessarabian students begins a real challenge of adapting to a new social and cultural life, to a new mentality: they must fit into a new society. Regarding the difficulty of adapting to the new environment, the Bessarabian students surveyed appreciate an average adaptation level of at least 4.869 and at most 5.491 (on a scale from 1 to 10) (Figure 3).

Figure 3. Bessarabian students' distribution by the adaptation to the new status

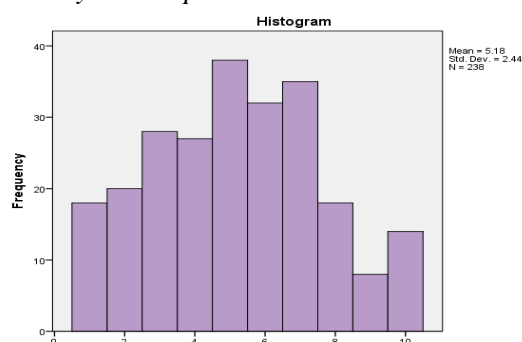

Source: authors' processing, based on survey data.

When asked to give their opinion on the experience and independence degree accumulated during the study period in

Romania, the analysis revealed (with a 95% confidence level) an average level between 7.82 and 8.26 (on a scale from 1 to 10, 1 = a total lack of experience and independence, 10 = maximum accumulation of experience and independence).

The degree to which Bessarabian students have gained experience and independence is average correlated with the degree in which they have made new friends (Pearson correlation coefficient: 0.42, statistically significant) [12]. Thus, the average level for which the Bessarabian students have made new friends during studies in Romania is 8.52 (on a scale from 1 to 10, where 1 = minimum, 10 = maximum level). Besides, 83.2% of the Bessarabian students do not distinguish between the nationality among the group of friends, accepting Romanian students as well (Figure 4). However, 72.8% of Bessarabian students claim that Romanian students marginalize them.

Figure 4. Group of friends



Source: authors' processing, based on survey data.

The distance from home and longing for loved ones are not impediments for studying in Romania. 55% of Bessarabian students go home only for holidays, and 20.2% of them - once every 2 months. Bessarabian students are satisfied overall with the opportunities offered them by Romanian state. 95.4% of them do not regret the enrollment in a Romanian university, being satisfied with the studies offered by the Romanian state.

### 3.3 Appreciating the intentions regarding the future careers of Bessarabian students

The analysis of the questionnaire responses revealed that 50.84% of

Bessarabian students are interested to attend master courses in Romania, and 37% of them want to continue their studies in another country. Also, after graduating, only 21% of young Bessarabian people who study in Romania intend to return to Moldova, while nearly 50% will seek employment in another country (Figure 5, 6).

Figure 5. Question 16/17: Where would you like to continue your master courses/professional activity after graduation? (Number of students)

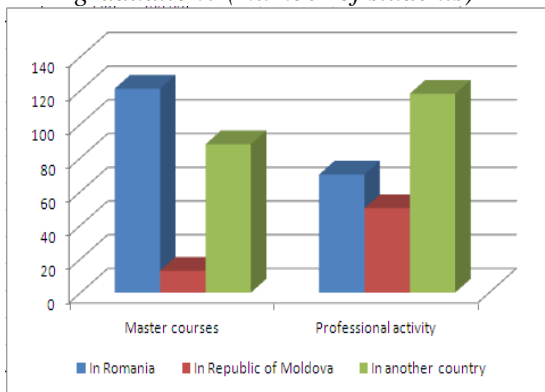

Source: authors' processing, based on survey data.

Figure 6. Question 16: Where would you like to continue your master courses after graduation? (%)

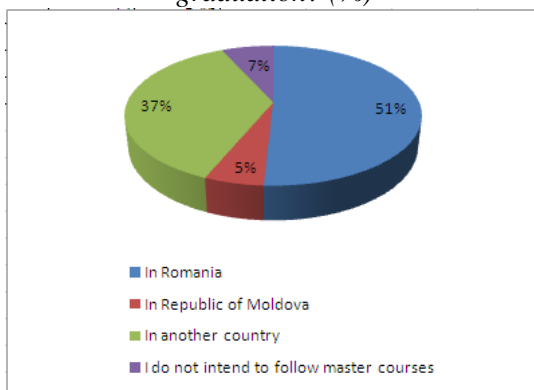

Source: authors' processing, based on survey data.

In addition to the opportunities offered by the Romanian state, most respondents consider that currently, in Western European countries there are much more chances to have a decent living. When asked if they would like to settle permanently in Romania, 63.4% of them gave a negative answer. They believe that in Moldova they will not be judged by their potential, the economic, social and political system being perceived as

outdated and blocked by corrupted and ancient practices.

#### 4. Conclusions and future work

Migration of young Bessarabians to Romania or other areas, professionally and economically attractive is a natural reaction to the lack of prospects on the labor market in Republic of Moldova. Young Bessarabian oscillates between the desire for freedom and mobility, respectively the desire and even the necessity to search for a better future.

Theoretical analysis and contribution to the study of migration experienced a diversity of approaches. The research method based on survey-questionnaire has led us to the following conclusions: Bessarabian student is very responsive about his integration in Romanian society. Given the chance to study in Romania, the student wishes in most cases to learn about Romanian culture. Interestingly – being asked what are the advantages of Bessarabian students - 42% of all students surveyed have mentioned new experiences and only 19% have mentioned the conditions offered by the Romanian state. Although students are satisfied with the program of studies in Romania, only half of them will apply for the master's program in Romania, while 36.4% are interested in following the master in another country. Most times he sees his future in another country, rather than in Romania or Moldova. Although Bessarabian students declare that they come in Romania due to higher education level and due to the prestige of Romanian academic centres, they often come mainly because they want to leave the country. Relations between the Romanian and Bessarabian students are generally good.

The results of this study will facilitate the authors identifying a profile of Bessarabian student who attends university in Romania and a model for explaining the migration behavior of young Bessarabian for educational purposes.

#### 5. References

[1] Costin, N., "Rethinking brain drain in Moldova: migration youth development", submitted to Central European University, Department of Economics, Budapest, 2012,

- pp. 1-7.
- [2] Harttgen, K., Klasen, S., "Well-being of Migrant Children and Migrant Youth in Europe",  
<http://globalnetwork.princeton.edu/bellagio/harttgen%20klasens%20final.pdf>; University of Göttingen, Department of Economics, Germany, 2008.
- [3] Hatton, T.J., Williamson, J.G., "What fundamentals drive world migration?",  
<https://ideas.repec.org/p/nbr/nberwo/9159.html>; NBER Working Paper Series, Working Paper 9159, National Bureau Of Economic Research, Cambridge, 2002.
- [4] OECD, "How many students study abroad and where do they go?", in *Education at a Glance 2013: Highlights*, OECD Publishing,  
[http://dx.doi.org/10.1787/eag\\_highlights-2013-12-en](http://dx.doi.org/10.1787/eag_highlights-2013-12-en), 2013.
- [5] United Nations Organization, "Youth and Migration",  
<http://www.un.org/esa/socdev/documents/youth/fact-sheets/youth-migration.pdf> ; UNO, 2011.
- [6] Maddok N., Ramguttee L., "Youth unemployment and poverty in Moldova",  
[http://www.undp.md/publications/economic\\_crisis/Youth\\_unemployment\\_in\\_Moldova\\_Youth\\_Day\\_En.pdf](http://www.undp.md/publications/economic_crisis/Youth_unemployment_in_Moldova_Youth_Day_En.pdf).
- [7] <http://www.iom.md/>.
- [8] National Bank of Moldova,  
<http://www.bnm.org/>, 2009.
- [9] <http://www.statistica.md/>.
- [10] Boboc, C., *Analiza statistică multidimensională: aplicatii în studiul calității produselor și serviciilor*, Meteor Press Publishing House, Bucharest, 2007.
- [11] Niculescu-Aron, I. G., *Tehnica sondajelor: aplicatii și teste de verificare*, Bucharest Academy of Economic Studies Publishing House, Bucharest, 2005.
- [12] Voineagu, V., Titan, E., et.all, *Statistica. Baze teoretice și aplicatii*, Economic Publishing House, Bucharest, 2007.

## Statistical-Based Insights in the Migration Process

Mihaela Grecu

*Bucharest University of Economic Studies, Department of Statistics and Econometrics*  
[mihaela\\_grecu24@yahoo.com](mailto:mihaela_grecu24@yahoo.com)

Emilia Titan

*Bucharest University of Economic Studies, Department of Statistics and Econometrics*  
[emilia\\_titan@yahoo.com](mailto:emilia_titan@yahoo.com)

### Abstract

*An increasing body of literature tries to find out what are the main factors that potentially determine people to migrate. Over time, many theories have been developed - each offering a different perspective on this phenomenon.*

*The aim of this study is to provide statistical evidence of the migration process and to briefly discuss the main factors that potentially lead the people to migrate.*

*The present paper offers useful theoretical information with regards to the migration process.*

*The statistical method used is the multiple regression, by taking into account the number of marriages, the unemployment rate and GDP as independent variables and the number of emigrants as dependent variable. The analysis is made for Romania.*

**Key words:** migration, unemployment

**J.E.L. classification:** A12, C01, F22

### 1. Introduction

The migration process is gaining more and more attention in the specialty literature. The evolution of this phenomenon is based on many factors. The factors can be divided into economic (unemployment, low wages), social (security, health system), political factors. Over time, many theories have been developed - each offering a different perspective on this phenomenon. In the below figure are synthesized the theories of migration (according to Bijak, Zlotnik and Kupiszewski).

Figure 1. Theories of migration

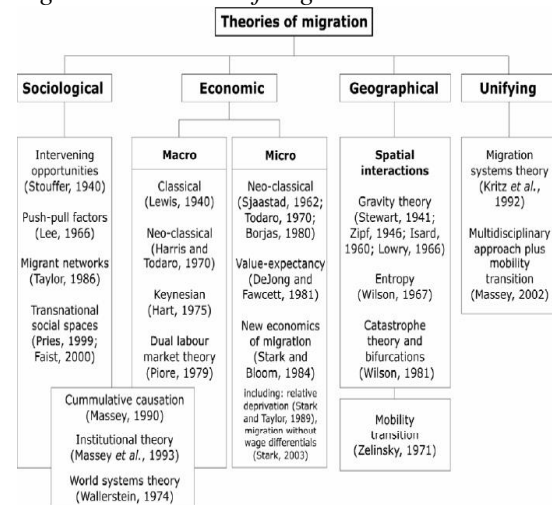

Source: Bijak J. [1]

From our point of view the most important classification of the migration phenomenon is the division of it in two parts: internal migration and international migration. Internal migration is the mobility within the country borders, while international migration is the mobility outside the home borders.

It is necessary for the migration phenomenon to be analyzed in relation to other fields, not being limited to demography only. Since international migration is a very complex and multi-dimensional phenomenon, modeling and predictions made on this phenomenon involve merging several science disciplines: demography, economics, statistics, sociology, political science, or even advanced methods of theoretical physics. [1]

International migration can be also related to young people who go study abroad (this happens when the universities from other countries are better than the ones from the host country), not only to the labor market.

An important body of literature states that education plays a significant role for the inclusive growth of the young people since it leads to empowering people through employment, poverty reduction, investment in development and innovation. [3]

Migration is based on the *push* and *pull* model. Push type factors are factors on which individuals decide to migrate. Pull factors are the factors on which individuals choose where to emigrate. In conclusion, migration may be viewed as a phenomenon involving a selective process. [4]

When it comes to migration, it's well known that Romania has always been a sending country, with people migrating mostly to Italy, Spain, Hungary, Israel, USA, Germany, Canada, Austria, France and United Kingdom. [5]

The immigration process can be seen as an opportunity for both sending and receiving countries. The immigrants can have access to better living conditions, better studying conditions, increased social protection, better medical services.

Immigration could be an opportunity, since it could have very positive effects for those people, who do not have enough economic opportunities in their home countries, in order to find a place in the labor market of the destination country and employment and better living conditions, and also for the host country, which could benefit from the immigrants flow if it is consistent with their socioeconomic and demographic characteristics. [6]

## 2. Data and methods

The below figures strengthen the idea that Romania is a sending country. One can also observe that Italy, for example, plays the role of host country for immigrants – most of them being Romanian citizens. [6]

Another country included in our analysis is Norway, which is a very developed country. Roughly, we can conclude that in Norway the number of emigrants is about the same as the number of immigrants, the number of immigrants being slightly higher. The flow of emigrants takes place between Nordic countries: Denmark, Sweden and Norway. Most of the Norway citizens migrate to Sweden, while In Norway most of the migrant citizens are from Sweden. [6]

Figure 2. Number of emigrants

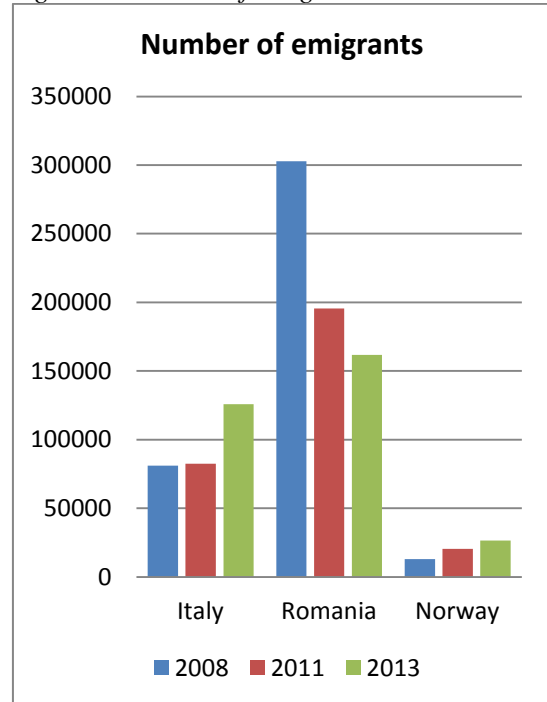

Source: <http://ec.europa.eu/eurostat.com>

Figure 3. Number of immigrants

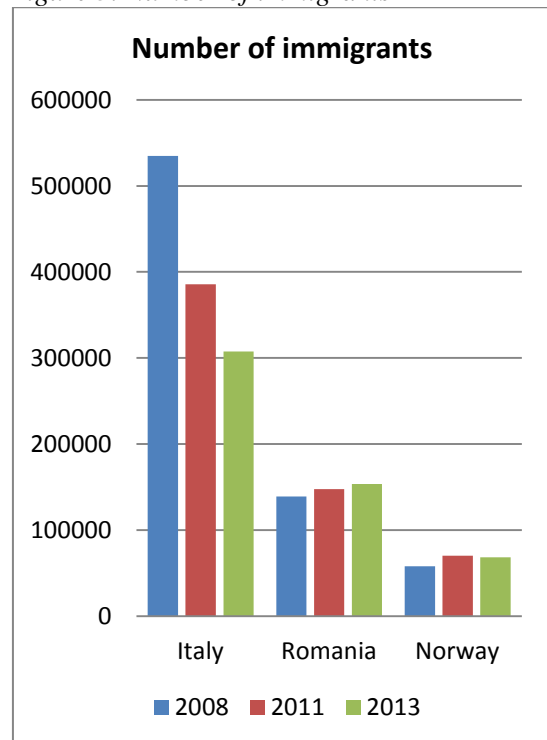

Source: <http://ec.europa.eu/eurostat.com>

It is well known that the unemployment rate has an impact in the evolution of many fields. The migration process is one of the fields affected by the unemployment rate.

Figure 4. Unemployment rate

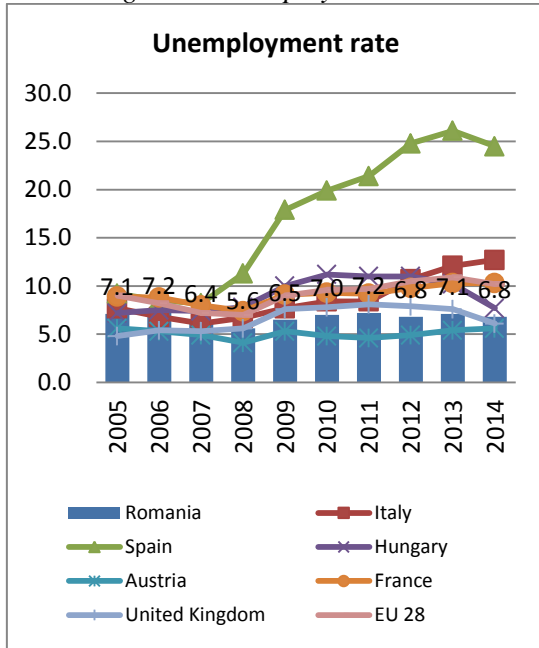

Source: <http://ec.europa.eu/eurostat.com>

From the above figure it can be observed that while the unemployment rate decreases in Romania, in the host countries for the Romanian emigrants the unemployment rate increases. The unemployment rate for Spain was in 2014 24.5%, while in Romania was 6.8%. It is well known that Spain is one of the most affected countries by the global economic crises. At the opposite side are Germany and Austria with an unemployment rate of 5% for Germany and 5.6% for Austria. One thing that deserved to be mentioned is that the unemployment rate in Romania is much smaller than the EU 28 unemployment rate.

The source of the data included for our multiple regression is EUROSTAT. [7]

The dependent variable is the *number of emigrants* and the independent variables are the *unemployment rate*, *GDP* and the *number of marriages* for Romania. We used the multiple regression analysis in order to emphasize the most important factors that influence the migration process. We tried to include a various type on indices – economic and social ones – in order to create a very accurate model. The statistical data processing was conducted using SPSS software. The data was registered from 2008 to 2013. Due to the absence of the data for the emigration index we did not include the years 2004 to 2007 and 2014 in the analysis.

### 3. Results and discussion

We have strong correlations between the number of emigrants and the independent indices. We have positive correlation between the number of emigrants and the number of marriages (0.966). Between the number of emigrants and the unemployment rate we have a strong negative correlation (-0.908). We have a negative weak correlation between the number of emigrants and GDP (-0.307).

Table 1. Correlations

		Emigrants	Marriages	Unemployment rate	GDP
Pearson Correlation	Emigrants	1	<b>0.966</b>	<b>-0.908</b>	<b>0.037</b>
	Marriages	0.966	1	-0.94	0.135
	Unemployment rate	-0.908	-0.94	1	0.185
	GDP	-0.037	-0.035	-0.185	1

Source: <http://ec.europa.eu/eurostat.com>

The method used for the multiple regression analysis is “Backward”. According to the table “Variables Entered/Removed” from the output, the index Unemployment rate and GDP were excluded.

The new model explains 93.3% of the variability of the Number of Emigrants –  $R^2=0.933$ ).

Table 2. ANOVA

Model		Sum of Squares	df	Mean Square	F	Sig.
1	Regression	13227842851.190	3	4409280950.397	9.248	.099 <sup>e</sup>
	Residual	953590387.643	2	476795193.822		
	Total	14181433238.833	5			
2	Regression	13227697849.046	2	6613848924.523	20.804	.017 <sup>d</sup>
	Residual	953735389.788	3	317911796.596		
	Total	14181433238.833	5			
3	Regression	13227562338.769	1	13227562338.769	55.469	.002 <sup>e</sup>
	Residual	953870900.064	4	238467725.016		
	Total	14181433238.833	5			

Source: <http://ec.europa.eu/eurostat.com>

Since the value of the Sig.  $F=0.002<0.05$  (table 2) there is a statistically significant relationship between the dependent and the independent variables.

The *collinearity* indicates the existence of a strong correlation between the independent variables. The *tolerance* can have values between 0 and 1. As the smaller is the value, nearest 0, the independent variable  $x_i$  can be explained by a linear combined of the other independent variables. [8]

In our model, at this moment we have only one independent variable – this means that the *tolerance* is 1.

In regards to the “Collinearity Diagnostics” we have the *Condition Index* represented in the below table. An index greater than 15 indicates that there is a possible collinearity problem. [8]

In the present analysis the *condition index* is 14.765 (table 3). The *variance proportion* for the removed indices – the unemployment rate and GDP – shows collinearity problems. The unemployment rate influences the variance in proportion of 0.97 and the GDP in proportion of 0.93.

Table 3. Collinearity Diagnostics

Model	Eigen value	Condition Index	Variance Proportions				
			(Constant)	Marriages	Unemployment rate	GDP	
1	1	3.973	1	0	0	0	
	2	0.023	13.055	0	0.03	0.01	0
	3	0.004	32.697	0	0.02	0.02	0.44
	4	8.96E-05	210.522	1	0.94	<b>0.97</b>	0.56
2	1	2.985	1	0	0	0	
	2	0.013	15.075	0.02	0.91		0.07
	3	0.002	40.973	0.97	0.09		<b>0.93</b>
3	1	1.991	1	0	0		
	2	0.009	<b>14.765</b>	1	1		

Source: <http://ec.europa.eu/eurostat.com>

The equation of the fitted model is:  
**Number of Migrants = -132558.417309+ 2.873918\* Number of Marriages**

#### 4. Conclusions

In regards to the migration process, Romania has always been a sending country, with people migrating mostly to Italy, Spain,

Hungary, Israel, USA, Germany, Canada, Austria, France and United Kingdom.

Even if Romania is a sending country it is important to notice that the number of emigrants was reduced to half in 2013 compared to 2008. When it comes to immigration, Romania received with 10% more immigrants in 2013 than in 2008.

This thing can lead us to conclude that the unemployment rate in the host countries for romanian emigrants increased a lot in the last years.

We have positive correlation between the number of emigrants and the number of marriages (0.966). Between the number of emigrants and the unemployment rate we have a strong negative correlation (-0.908). Between the number of emigrants and GDP (-0.307) we have a negative weak correlation.

There are as many reasons for migration as there are migrants, but most individuals who cross national borders do so for economic reasons. [9]

#### 5. References

- [1] Bijak J., Forecasting International Migration: Selected Theories, Models, And Methods, Central European Forum For Migration Research, CEFMR Working Paper 4/2006, 2006
- [2] Zamfir C., Vlasceanu L, Dictionar de Sociologie, Ed. Babel, Bucuresti, 1998
- [3] Grecu M., Titan E., Druica E., Investigating the Costs of Education in the European Union, Procedia Economics and Finance, Vol. 23, 2015
- [4] Etzo I., Internal Migration: a review of the literature, MPRA Paper No. 8783, 2008
- [5] [http://peoplemov.in/#f\\_RO](http://peoplemov.in/#f_RO)
- [6] Mihi-Ramirez A., Metelski D., The Migration Flow Between Lithuania and Spain: A Study of Economic Factors, Intelectual Economics Vol. 7, No. 4(18), 2013
- [7] <http://ec.europa.eu/eurostat.com>
- [8] Jaba E., Grama A., Analiza statistica cu SPSS sub Windows, Ed. Polirom, Iasi, 2004
- [9] Kumpikaite V., Zickute I., Regression Analysis of Economic Factors Influencing Emigration Rate in Lithuania, Procedia Economics and Finance, Vol. 92, 2013

# Empirical Study on the Correlation Between the NPRD and the Amount of Funds Allocated by the Tractors and Main Agricultural Machines in 2011 - 2013

Nela Loredana Meită

University of Craiova

[loredanameita@yahoo.co.uk](mailto:loredanameita@yahoo.co.uk)

Jenica Popescu

University of Craiova

[jenica\\_popescu@yahoo.com](mailto:jenica_popescu@yahoo.com)

## Abstract

*In this study is estimated un econometric models, using linear regression, in which we try to measure the effectiveness of funds allocated through the National Plan for Rural Development in agriculture.*

**Key words:** funding, car fleet and tractoare value agricultural regression, correlation variables

**J.E.L. classification:** G23, G32.

The purpose of the analysis that we perform is caught in the first stage of our research, delimitation assumptions. To study the effect of structural funds in the agricultural sector will test the following two hypotheses:

H1: Between Structural Funds allocated to the agricultural sector and the value of the fleet of cars and tractors in the agricultural sector there is a strong correlation.

H2: Allocating funds for agriculture and rural development led to an increase in fleet value and tractors in this sector.

## 1. Introduction

In 2007-2013, Romania has benefited by funding for certain strategic programs through the European Structural Funds. Structural Funds are financial instruments used by the European Union in order to reduce regional development disparities between regions. In this sense, the funds should contribute to economic growth and to increase the efficiency of the areas covered by funds. [1]

Among the priority programs established by the Romanian authorities was recovered the agricultural sector, too. The funds allocated to the European Union through the European Fund for Agriculture and Rural Development, were absorbed by Romania through the **National Programme for Rural Development (NPRD)**. Generally, the funds allocated through the NPRD aimed to increase competitiveness in agriculture and forestry, improving the environment and the countryside and improving the quality of life in rural areas and diversify the rural economy. [2]

## 2. Methodology

To test the two hypotheses we'll use two of the most used tools empirical statistical correlation and linear regression : social and economic phenomena and processes. They are not generally independent phenomena, but they manifest as a result of the action of influencing factors and conditions, and they affects the manifestations of other actions. We say, therefore, that between mass phenomena there are manifest links, dependencies. The relationship between two statistical variables can be studied two techniques: regression and correlation. Correlation will show how strong is the bond of dependence between variables. The intensity of the relationship between the sizes of the random  $x$  and  $y$  are characterized by the coefficient of correlation. Regarding the correlation coefficient, there may be three situations:

- If the values are close to 1, this means that between the two variables there is a direct and high intensity;
- If the values are close to -1, this means that between the two variables are linked



- reverse and high intensity;
- If the values are close to 0, this means that the two variables are not related.

The method of least squares is the most simple mathematical method that can be used to determine a linear function of X and Y, which represent the relationship between the two variables. No straight line can't be perfect every observation chart. The general equation for the line is. The equation is estimated for the regression analysis:

$$\hat{Y}(X) = \hat{a} + \hat{b} X + e,$$

where:

- Y = the dependent variable;
- $\hat{a}$  = constant;
- $\hat{b}$  = the regression coefficient;
- X = independent variable;
- e – error, the difference between the actual and estimated through regression line. [3]

Estimated regression function describes the nature of the relationship between X and Y. In addition, it is interested in the relationship between X and Y. Power coefficient of determination, is the measure of power linear relationship between two variables.

### 3. Results and Comments

The results obtained through regression will allow us to describe and understand the relationships of dependence, to predict a new value of the variable effect and adjust and

control variable effect on the variable concerned by the intervention.

To test hypotheses  $H_1$  and  $H_2$  will use as the dependent variable and the value of the tractors main agricultural machinery in agriculture in one year (effect) and independent variable allocated through NPRD (cause).

In the next section we'll present the study results obtained by the tests mentioned. We note that all estimates were made using econometric software Eviews 4.1. [4]

In Table 1 it shows the model results estimated for 2011. As we can see, the model indicates a positive influence of European funds allocated through the NPRD on the value of the tractors and main agricultural machinery, the coefficient is positive but is not supported in statistical terms. Thus, increasing the monetary unit of the payments made by the NPRD will increase the value of the tractors and main agricultural machinery with 0.0000343 monetary units.

Coefficient shows that variation of the independent variable - European funds attracted by the NPRD - no surprise than 6.45% of the variance of the dependent variable - the value of the tractors and main agricultural machines.

I1: The hypothesis of independence of errors, using the Durbin-Watson statistic test ( $D_C = 1.87$ ;  $D_1 = 1.48$ ,  $D_2 = 1.57$  for  $\alpha = 0.05$  significance level and a total of 41 observations). It appears that the calculated value is higher theoretical test ( $D_C \geq D_2$ ) so the assumption of independence of errors is checked.

Table 1. Results of linear regression in 2011

Variable	Coefficient	Std. Error	t-Statistic	Prob.
C	7751.690	2096.776	3.696957	0.0007
PL	3.43E-05	2.09E-05	1.639835	0.1091
R-squared	0.064503	Mean dependent var		10951.32
Adjusted R-squared	0.040516	S.D. dependent var		5018.256
S.E. of regression	4915.546	Akaike info criterion		19.88574
Sum squared resid	9.42E+08	Schwarz criterion		19.96933
Log likelihood	-405.6577	F-statistic		2.689058
Durbin-Watson stat	1.868901	Prob(F-statistic)		0.109082

Source: own calculations

Note: „VPTMA” is the park's main agricultural tractors and agriculture machinery;

„PL” is payments made to beneficiaries in the agricultural sector NPRD

I2: The hypothesis of normality of errors using statistical test  $\chi^2$  (Jarque-Bera test).

After comparing the calculated theoretical value test is found that  $JB = 9.21 < \chi^2 = 43.77$

$p = 0.009$  and  $\alpha = 0.05$  so we can say that the assumption of normality of errors is not verified.

I3: Verify estimators of regression model parameters are significantly different from zero by using t statistical test. For  $a = 7751.69$  parameter estimator calculated value of the test ( $t_c = 3.7$ ) is higher compared to the theoretical value of the test ( $t_{0,05;40} = 1.96$ ), and the associated probability is 0 therefore is less than  $\alpha$  (0.05), so we can say that the estimator parameter is significantly different from zero. To the parameter estimator  $b = 3.43E-5$ , a calculated value for the test (RT = 1.64) is lower than the theoretical value of the test ( $t_{0,05;40} = 1.96$ ), and the probability of  $p = 0.11$  is greater than  $\alpha$ , then we can say that the estimator parameter  $b$  is not significantly different from zero.

I4: Check if funds are an important factor influencing the value of machinery park,

using statistical test comparing the computed value of test F ( $F_c = 2.69$ ) with the theoretical value ( $F_{0,05, 1, 39} = 4.17$ ) and probability  $p = 0.11$  is observed that is larger than  $\alpha$ , it appears that the funds do not constitute an important factor of influence for the value of machinery and agricultural machinery park.

After verifying the four hypotheses resulting econometric model:

**The value of the tractors and agricultural machines = 7751.69 + 3.43-05 \* Funds (R2 = 0.06)**

In Figure 1 is the regression line. Points to consider that a position above it indicates an above average performance, and those that are positioned below the regression line indicates poor performance.

Figure 1. Graphical representation of the value of the tractors and main agricultural machines and payments made by the NPRD in 2011

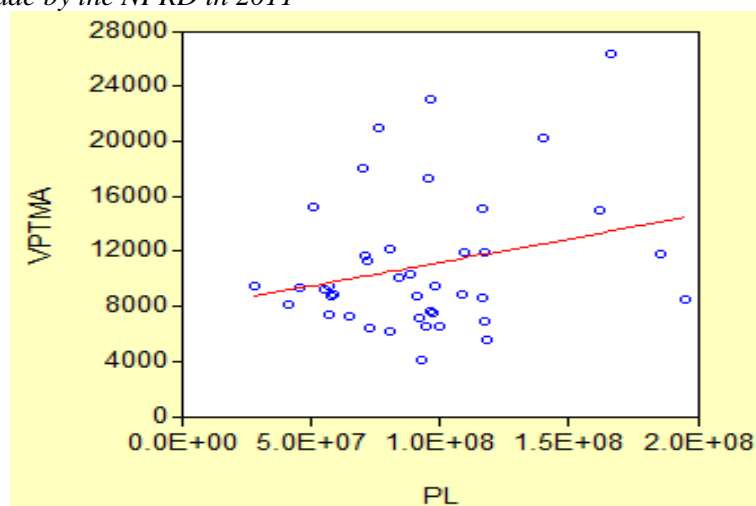

Source: own after data extracted from National Institute of Statistic (NIS) [5] and NPRD [6] databases

Note: OX axis is the amount of payments attracted NPRD beneficiaries;

OY axis is the value of the tractors and main agricultural machinery

In 2012, in the model, the influence of the independent variable on the dependent variable diminishes considerably, being close to 0. Moreover, the influence of European funds on the value of the tractors and main agricultural machinery decreases compared with 2011, from 0.0000254 to 0.0000343, and rejected the coefficient is statistically. On the other hand, the coefficient does not reveal

an improvement of the validity of the model.

Figure 2 show a greater heterogeneity of how counties are placed against the regression line, indicating a different degree of efficiency. Points to consider that an above position it indicates an above average performance, and those that are positioned below the regression line indicates poor performance.

Table 2. Results of linear regression 2012

Variable	Coefficient	Std. Error	t-Statistic	Prob.
C	8770.455	1866.253	4.699500	0.0000
PL	2.54E-05	1.87E-05	1.358255	0.1822
R-squared	0.045167	Mean dependent var		11068.83
Adjusted R-squared	0.020684	S.D. dependent var		5092.810
S.E. of regression	5039.864	Akaike info criterion		19.93570
Sum squared resid	9.91E+08	Schwarz criterion		20.01929
Log likelihood	-406.6818	F-statistic		1.844855
Durbin-Watson stat	1.839377	Prob(F-statistic)		0.182189

Source: own calculations

Note: "VPTMA" is the park's main agricultural tractors and agriculture machinery;  
„PL" is payments made to beneficiaries in the agricultural sector NPRD.

Figure 2. Graphical representation of the value of the tractors and main agricultural machines and payments via NPRD 2012

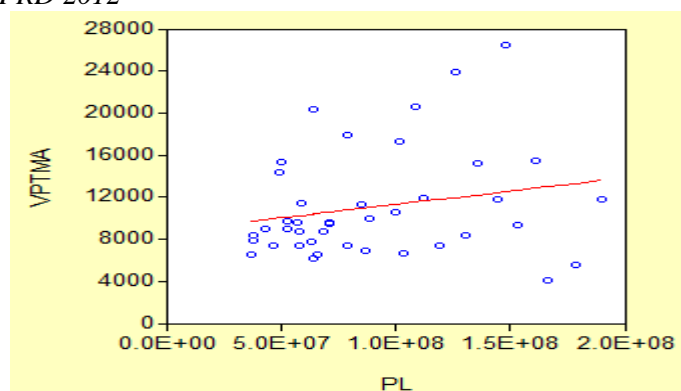

Source: own after data extracted from NIS and NPRD databases

Note: OX axis is the amount of payments attracted NPRD beneficiaries;  
OY axis is the value of the tractors and main agricultural machinery

In 2013, the model, the influence of European funds on the value of the tractors and main agricultural machinery is positive, but, again, the coefficient is statistically insignificant. Moreover, the change in value of the tractors and main agricultural

machines is explained only in proportion of 10.21% of the estimated model. In this case, we see an improvement in results, so even if the coefficient associated with EU funds is positive it is insignificant statistically.

Table 3. The results of linear regression 2013

Variable	Coefficient	Std. Error	t-Statistic	Prob.
C	7904.718	1830.641	4.318005	0.0001
PL	4.10E-05	1.95E-05	2.106016	0.0417
R-squared	0.102113	Mean dependent var		11420.90
Adjusted R-squared	0.079090	S.D. dependent var		5009.722
S.E. of regression	4807.532	Akaike info criterion		19.84131
Sum squared resid	9.01E+08	Schwarz criterion		19.92489
Log likelihood	-404.7468	F-statistic		4.435305
Durbin-Watson stat	1.938274	Prob(F-statistic)		0.041691

Source: own calculations

Note: „VPTMA" is the park's main agricultural tractors and agriculture machinery;  
„PL" is payments made to beneficiaries in the agricultural sector NPRD

Figure 3. Graphical representation of the value of the tractors and main agricultural machines and payments via NPRD 2013

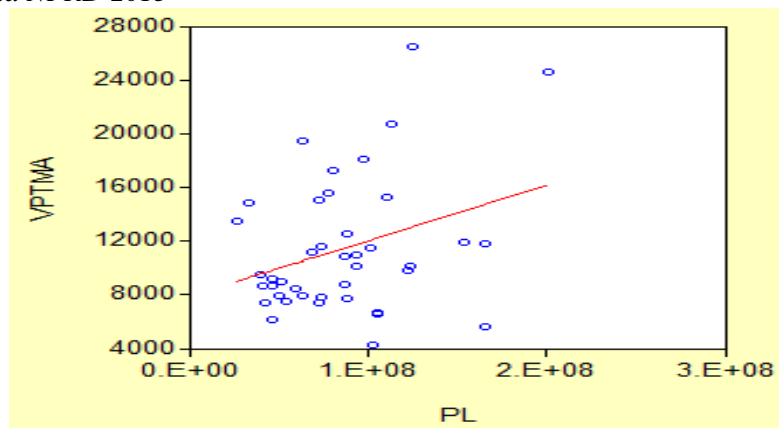

Source: own after data extracted from NIS and NPRD databases

Note: OX axis is the amount of payments attracted NPRD beneficiaries;

OY axis is the value of the tractors and main agricultural machinery

Given these results and the foregoing, we conclude that European funds have no significant influence on the value of the tractors and main agricultural machinery. In these circumstances hypothesis H2 is invalidated. Consequently, the allocation of funds for Agriculture and Rural Development has not led to an increase in the value of the tractors and man agricultural machines.

After verifying the four hypotheses resulting econometric model:

**The value of the tractors and agricultural machines = 7904.72 + 4.10-05 \* Funds (R2 = 0.102)**

#### 4. Conclusions

In conclusion, we can state firmly that the variables analyzed there is no correlation. The results confirmed the model and estimated using linear regression. Both assumptions made available in the initial stage of the study were invalidated by empirical models. The European funds allocated through NPRD

or have an influence very low on the value of the tractors and main agricultural machinery or the coefficient associated with this variable is not significant in statistical terms, leading to the rejection of the hypothesis H1, ie between the Structural Funds allocated to the agricultural sector and the value of tractors and main agricultural machinery park's there is not a strong correlation.

#### 5. References

- [1] Bărgăoanu, A., *European funds. Strategies to promote and use*, Publisher Tritonic, Bucharest, 2009;
- [2] Stanef, M.R., *Romanian agriculture to the demands of the European Union*, Publisher ASE, Bucharest, 2010;
- [3] Andrei, T., *Statistics and Econometrics*, E Economic Publishing House, Bucharest, 2003;
- [4] \* \* \* EViews, User Guide, Version 6.0, QMS Quantitative, Micro Software, Irvine, California;
- [5] \* \* \* www.insse.ro;
- [6] \* \* \* www.pndr.ro.

# A Region of Welfare and a New Path for Europe

**Constantin Schipor**

*University "Alexandru Ioan Cuza"*

*Doctoral School of Economics and Business Administration*

[constantin.schipor@ymail.com](mailto:constantin.schipor@ymail.com)

## Abstract

*By 2020, the European Union, prefigures an economic and social system based on social and economic policy coordination in order to generate the growth for a sustainable development, for the level of employment and social cohesion. The challenges faced by the European Union are greater than before the recession and have a much broader area, starting with fundamental economic issues to social instability.*

*This paper provides an overview of how the European social model should revive the economic system. The main hypothesis of the paper assumes that social market economy with valence in social responsibility can be a viable solution for the future of the European Union.*

**Keywords:** welfare state, social market economy, economic crisis, austerity.

**Clasificare J.E.L.:** F20

## 1. Introduction

What has been found when a country's economy is weak, its social system suffers more than anything else, whereas a stable currency safeguards the beneficial social effects of a competitive system. Social regulation needs as much attention as financial regulation as it is only in this way that states can guarantee that their citizens will profit from the economic system.[1]

In early 2010, the European Commission proposed the Europe 2020 strategy and was launched the European Union strategy for smart and sustainable growth.

The objective was to increase European Union competitiveness, while preserving its model of social economy market and significantly improving its resource

efficiency.

Europe 2020 strategy promoted a model of development that requires more than GDP growth. Currently, many organizations focus on smart, sustainable and inclusive growth for economic development.

Europe 2020 is the European Union growth strategy for the coming years. In a world constantly changing, the European Union wants to have a smart and sustainable economy. These three priorities are mutually supportive and are able to help the European Union and Member States to achieve a high level of labor employment, productivity and social cohesion. In this regard, the European Union has set five major goals to be met by 2020.

- a) Employment rate of the population aged between 20 and 64 years to grow to at least 75%;
- b) Invest 3% of EU GDP in research and development;
- c) Achieve the objective "20/20/20" climate / energy:
  - reduce greenhouse gas emissions by at least 20% compared to 1990;
  - increasing to 20% the share of renewable energy in final energy consumption;
  - 20% increase in energy efficiency.
- d) Reducing the dropout rate from the current 15% to 10% and increasing the share of people aged between 30 and 34 years with higher education from 31% to at least 40% in 2020.
- e) The number of Europeans living below national poverty lines should be reduced by 25%, which would mean lifting over 20 million people out of poverty.

## 2. European Union Member States between aspirations and achievements

In 2009, the European economy suffered a contraction without precedent, namely a decrease of 4.5% of GDP. The economic

decline has stopped temporarily for a short period in 2010, but negative trends resumed in 2011 and 2012. From 2013 there is a gradual recovery and it is estimated that it will continue. As predicted, the gross domestic product per capita will grow again by 1.5% in 2014 and 2.0% in 2015.

Since the launch in 2010 of the Europe 2020 strategy, the scale and duration of the crisis were still largely unknown. There have been considered several scenarios for the next decade, including: a return to a "strong" growth, "slow" recovery or the risk of a "lost decade". Many things depend on the ability of the EU to quickly and decisively solve the issues.

An essential first step for the development of an EU strategy for the post-crisis growth is full understanding of the impact of the crisis and the agreement on a common diagnosis situation of where Europe is.

In this regard, it is also important to remember that trying to return to a "model" of growth from the past decade would not be only illusory but also harmful: fiscal imbalances, housing bubbles, social inequalities, lack of entrepreneurship and innovation, financial dysfunctional systems, energy dependency pressure increasing on resources, increase of unemployment, weaknesses in education and training systems, poor public administrations performance - all these phenomena could be observed, but not solved in the past.

*Table 1 Employment rate of the population aged between 20 and 64*

No.	Country	2012 [%]	2013 [%]	2014 [%]
1.	<b>Austria</b>	74.2	74.4	74.2
2.	<b>Belgium</b>	67.2	67.2	67.3
3.	<b>Bulgaria</b>	62.9	63	63.5
4.	<b>Croatia</b>	57.1	58.2	59.2
5.	<b>Cyprus</b>	70.2	67.2	67.6
6.	<b>Czech Republic</b>	71.5	72.5	73.5
7.	<b>Denmark</b>	75.4	75.6	75.9
8.	<b>Estonia</b>	72.2	73.3	74.3
9.	<b>Finland</b>	74	73.3	73.1
10.	<b>France</b>	69.4	69.5	69.9
11.	<b>Germany</b>	76.9	77.3	77.7
12.	<b>Greece</b>	55	52.9	53.3
13.	<b>Hungary</b>	61.6	63	66.7
14.	<b>Ireland</b>	63.7	65.5	67

No.	Country	2012 [%]	2013 [%]	2014 [%]
15.	<b>Italy</b>	60.9	59.7	59.9
16.	<b>Latvia</b>	68.1	69.7	70.7
17.	<b>Lithuania</b>	68.5	69.7	70.7
18.	<b>Luxembourg</b>	71.4	71.1	72.1
19.	<b>Malta</b>	63.1	64.8	66.3
20.	<b>Netherlands</b>	76.6	75.9	75.4
21.	<b>Poland</b>	64.7	64.9	66.5
22.	<b>Portugal</b>	66.3	65.4	67.6
23.	<b>Romania</b>	64.8	64.7	65.7
24.	<b>Slovakia</b>	65.1	65	65.9
25.	<b>Slovenia</b>	68.3	67.2	67.8
26.	<b>Spain</b>	59.6	58.6	59.9
27.	<b>Sweden</b>	79.4	79.8	80
28.	<b>U.K.</b>	74.1	74.8	76.2
29.	<b>UE 28 average</b>	<b>68.4</b>	<b>68.4</b>	<b>69.2</b>

Source: Eurostat

As can be seen in Table 1, the average of employment rate of the population aged between 20 and 64 years slightly increased, but 75% target is far from being reached. Economic and social problems faced by Greece, Spain, Portugal and the eastern european states will not allow achieving this goal by 2020.

Unemployment increased rapidly in Europe due to the global crisis, from a rate of 7.1% in 2008, to a peak of 10.9% in 2013. The situation became chronic in time. Long-term unemployment, namely the percentage of the active population unemployed for over a year - increased by 2.1 percentage points between 2008 and 2012 (from 2.6% to 4.7%). This could indicate an increase in structural unemployment, severely affecting employment and the potential growth of the economy, but also the risk of increasing poverty and social exclusion.

During the twentieth century, global consumption of fossil fuels increased 12 times, and the extraction of material resources by 34 times. Currently, in the European Union, each person consumes 15 tonnes of materials and produce 5 tons of waste, of which half is going to landfill. Businesses face increasing costs of higher critical raw materials, energy and minerals, the lack of security of supply and price volatility have negative effects on the economy. Sources of minerals, metals and energy, stocks of fish, timber, water, fertile soils, clean air, biomass and biodiversity are

under pressure, as well as the stability of the climate system. Demand for food, feed and fiber may increase by 70% by 2050 and 60% of major ecosystems in the world that produce resources have already been degraded or are used unsustainably.

Due to the measures taken by Member States so far the greenhouse gas emissions have reduced by almost 20%. The policies implemented currently, on climate and energy, contributed to this positive result.

Thanks to new technologies, as well as vastly increased responsibility in environmental protection, is expected by 2020 to have more visible results.

Given the level of 2.06% achieved in 2012 and the limited progress achieved in time, reaching the 3% target set for 2020 is unlikely. According to the forecasts, investments in research and development will increase to 2.2% by 2020. If Member States meet their national targets, this percentage may rise to 2.6%.

Regarding dropout rate there have been made major progress. Regionally, between 2005 and 2015 there was a reduction of about 4%. In this segment the question remains, as this improvement is not due entirely to a deep structural change, but because of difficult conditions in the labor market.

### **3. Problems faced by the European Union's economic system**

The economic and social system of the European Union is successful. But its new challenges are mostly global: the rise of Asia, climate change, the end of the industrial age, the information revolution and an aging population. To address these effectively, the European Union should draw strength from its values of human rights, freedom, democracy, equality and care for people and the environment. In the years to come, it will need to rely increasingly upon three key resources: the people, the sun as an energy source, and the Union itself.[3]

Analyzing the situation in the European Union, the population has increased every year between 1960 and until today, with an overall increase of 98.9 million, equivalent to an annual growth rate of 0.4%. Population growth in the EU largely reflected developments in the natural growth rate, unlike migration trends. Closer analysis

shows that the natural population growth for the entire region peaked in 1964, when there were 3.6 million more births than deaths.

Birth rate declined progressively and gradually increased life expectancy, resulting in a slowdown in the natural growth rate. In 2003, natural population growth in the 28 EU Member States was almost balanced. Subsequently, the birth rate and natural population growth increased again to some extent in several Member States, although the general trend was reversed when the financial and economic crisis hit.

Across the European Union, younger people, aged between 0 and 14 years old represented 15.6% of the total population on 1 January 2013, while people of working age 15-64 accounted for about two-thirds (66, 2%) of the total, which means that the elderly (older than 65 years) accounted for about 18.2% of the population.

The aging population has a profound impact on society and the economy of Europe. Net migration is and will be necessary due to demographic trends. Net migration since 1992 has exceeded natural increase (the difference between births and deaths) and now represents two thirds of the growth of Europe population. It is estimated that economic dependency - the ratio of people without the number of persons in employment - will increase from 1.32 in 2010 to 1.47 in 2030 and dependency of older people will create unprecedented challenges to financial sustainability and social protection systems.

Another barrier is the issue of equity goals, namely the distribution of income in the economy. While GDP and wealth continued to grow significantly, inequality began to widen in Europe.

Currently there are profound inequalities in income distribution in the EU: in 2014, on average, the richest 20% had incomes 6.3 times higher than the poorest 20%. This ratio varies significantly across the EU, from 3.6 in Slovenia and 3.9 in the Czech Republic, to over 7.0 in Greece, Romania, Latvia and Bulgaria, reaching a peak of 7.4 in Spain.

The current economic crisis has led to an increase of inequality and put pressure on redistribution systems. The issue of equity distribution increases the difficulties in meeting the challenges facing European economies.

Freedom of religion is under threat and cultural diversity needs legal protection. Meanwhile, religious institutions can play a substantial role in mitigating the crisis by offering solidarity and reinforcing human dignity. It is important that politics provide answers for the future regarding democracy, values, the social market economy and sustainable growth. As the party of values, the European People's Party (EPP) should play a central role in ensuring solidarity, freedom of religion, pluralism and universal values.[4]

Expenditure on education is an investment for the future, perhaps the most important investment for each individual, but also for the state. Through education the ethics and morality of individuals is reinforced.

Figure 1 Total public expenditure on education as % GDP

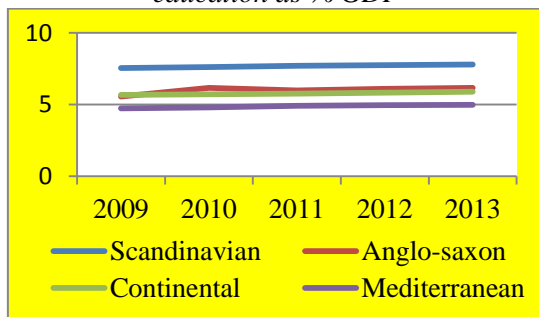

Source: Eurostat

The data in Figure 1 highlights the differences between the amounts allocated for education in each of the four regions representing the European Union. Nordic States allocate significant funding to this area, and the results are embodied in the high living standards.

#### 4. Conclusios

The current financial crisis has questioned the efficiency of the economic and social system of the European Union. In this time of great trials, namely financial crisis and the current issue of immigrants, it's tested the viability of the largest integrated area. Even if in recent years economic and social system of the European Union has been siege by various problems, it will remain feasible because the policies adopted from the beginning until currently improved the living standards and supported a sustainable

development.

Regional problems rooted in ethics and morality of individuals that govern economic and social activity. If certain aspects of financial mechanisms may be solved soon by stimulus measures, like reducing the interest rate and credit facilitation or reducing taxes to encourage entrepreneurs, those related to moral and ethical values require decades. In another view, the issue of birth has strong roots in the individual perception about the family.

In recent decades raising living standards and the multitude of possibilities for a successful career, the desire to have children has decreased dramatically. Reversing the birth-death ratio can only be done through a change of moral values of the individual. Financial incentives in this regard is only a short term measure without echo in the distant future. In terms of reducing greenhouse gas emissions the solution is based on the same measures.

This work was co-funded by the European Social Fund through Sectoral Operational Programme Human Resources Develepment 2007 – 2013, project number POSDRU/187/1.5/S/155397, project title „Towards a New Generation of Elite Researches through Doctoral Scholarships”.

#### 5. References

- [1] Borchard M, „*The social market economy as a bridge in times of crisis: 'Human dignity shall be inviolable'*”, *European view*, Vol. 8, Issue 1, 2009, pp. 13-20.
- [2] Martens W., „*Europe 2020 and Beyond*”, *European view*, Vol. 9, Issue 1, 2010, pp.1-3.
- [3] Turk Z., „*Europe 2030: The citizens, the sun and the Union*”, *European view*, Vol. 9, Issue 1, 2010, pp. 79-92.
- [4] Mauro M., „*Religious aspects of politics*”, *European view*, Vol. 11, Issue 2, 2012, pp. 157-161.



**Section II**  
**Business Economy and Administration**

\*\*\*

**Subsection 1**  
**Economic and Social Studies**

## The Principle of Non-interference in Internal Affairs

Florica Braşoveanu

*The Faculty of Law and Administrative Sciences, Ovidius University of Constanta*

[floriordache@yahoo.com](mailto:floriordache@yahoo.com)

Constantin Anechitoae

*The Faculty of Law and Administrative Sciences, Ovidius University of Constanta*

[anechitoae@yahoo.com](mailto:anechitoae@yahoo.com)

### Abstract

*The principle of non-intervention has been known for a while as it was even stated by the founder of international law science, Hugo Grotius.*

*In terms of content, the principle entails the obligation of states not to interfere in affairs which fall within national competence of a State (belonging to the reserved area).*

*This principle excludes any form of intervention, not only the military (any form of interference or threats against the personality of the State or against its political elements, economic, cultural).*

**Key words:** peace, international disputes.

**J.E.L. classification:** K33 - International Law

### 1. Introduction

If, for centuries, intervention was considered as a means Legality of international conduct, the French Revolution is one that will stipulate non-intervention of the French people in the internal affairs of other nations and inadmissible intrusion by foreign powers in the internal affairs of France (art. 119 Constitution of 1793) [1].

In response, the legitimacy of intervention is ruled at the Congress of Vienna in 1815. In other news, the Monroe Doctrine (1823) establishes the inadmissibility of intervention of European countries on the American continent [2].

Doctrines of Calvo and Drago (1868 and 1902), aimed to substantiate the inadmissibility of intervention in any form, on the South American continent, under the pretext of the existence of public debts or

causing of damage to foreign citizens following coups or civil wars.

### 2. The principle of non-interference in internal affairs as a fundamental principle of public international law

The general principles of law recognized by the State means the principles as such (without any particular connotation).

The Principles of Public International Law are a basis for the development of international law, they allow, if necessary, an adaptation of international law to new demands imposed by the international society and sometimes even cover certain gaps [3].

More problems considered as belonging exclusively, in the past, to the domestic jurisdiction of states go outside the reserved area today. An example of this is the current trend of legalization of so-called humanitarian or democratic intervention rights.

The principle of non-interference in the internal affairs of a State was affirmed by Hugo Grotius in the 17th century, it was affirmed in some international documents in the interwar period, such as the League of Nations Covenant.

It finds its full consecration only after the II World War, as enshrined in the UN Charter (art. 2, § 7); Bogota Pact Constitution of the Organisation of American States (OAS) - art. 15; Covenant of the League of Arab States; Charter of the African Union (OAU); UNESCO Constitution [4]. Also, it has found special attention with the rules of the Vienna Convention 1961 and 1963 on Diplomatic and Consular Relations.

*So his consecration as a fundamental principle of public international law is carried out by the UN Charter, art. 2 pt. 7:*

*"Nothing in the present Charter shall authorize the United Nations to intervene in matters which are essentially within the domestic jurisdiction of any state or shall require the Members to submit such matters to settlement under the present Charter".*

The principle of non-intervention can not be understood only in the context of all the fundamental principles of international law and thus it is the obligation of states not to interfere in the internal affairs of other countries and not to undertake any action that would impede the right to self-determination whatever means used, be it by military force, be it about any other form of interference, economic or political, directly or indirectly [5].

Trebuie menționat că acest principiu nu afectează posibilitatea de intervenție de către Consiliul de Securitate în cadrul Cap. VII al Cartei ONU, dar numai în cazul în care acesta găsește existența unei amenințări la pace, încălcare a păcii sau act de agresiune.

### **2.1. Interference in internal affairs – means of international illicit conduct**

Pentru secole, intervenția a fost considerată un mijloc legitim de conduită internațională.

Datoria de a nu interfera în probleme care aparțin competenței naționale a unui stat este un principiu fundamental al dreptului internațional, deoarece numai în acest fel relațiile dintre state se dezvoltă, încrederea dintre oameni se întărește și se construiește, relațiile de respect reciproc se dezvoltă [6].

În începutul secolului al XX-lea, non-intervenția a fost unul din principiile de bază ale dreptului internațional, devenind din ce în ce dominant în gândirea noilor state și actorilor internaționali [7]. Astfel, de la începutul secolului, principiul non-intervenției a câștigat în importanță în sfera internațională, perioadă în care Conferința de la Haga din 1907 a fost marcată de un interes sporit în procedurile pentru soluționarea pașnică a controverselor dintre state, devenind astfel metoda principală folosită de comunitatea internațională pentru evitarea războiului [8].

Conform Cartei ONU din 1970, niciun stat sau grup de state nu are dreptul să intervină, direct sau

indirect, în problemele interne sau externe ale altor state.

Principiul non-intervenției în problemele interne ale altor țări este inclus în:

- ✓ prohibiția intervenției armate sau a altor forme de interferență, amenințare;
- ✓ să nu se folosească sau să nu se încurajeze utilizarea măsurilor economice, politice sau a altor opinii în scopul de a constrânge alt stat;
- ✓ să nu se susțină, să nu se instige, să nu se finanțeze, să nu se încurajeze, să nu se tolereze activități subversive sau teroriste armate;
- ✓ să nu se intervină în conflictele interne ale altor state;
- ✓ să nu se aplice forța în scopul de a priva popoarele de dreptul la identitate națională;
- ✓ dreptul fiecărui stat să aleagă sistemul său politic, economic, social, cultural.

Acest principiu este crucial în promovarea și menținerea păcii.

Este cunoscut faptul că puterile majore - folosind superioritatea economică, militară, politică, tehnică și științifică - încearcă să intervină în problemele interne sau externe ale altor state [9].

### **3. Noninterference in internal affairs and nonaggression**

Non-intervenția în altă țară este în strânsă legătură cu non-agresiunea și cu neutilizarea amenințării cu forța, precum și cu alte norme și principii fundamentale ale dreptului internațional [10].

Istoria arată că intervenția în problemele altor state a fost comisă, de obicei, de cele mai mari și mai puternice țări ca o expresie a unei politici de dictare a subordinației și a opresiunii. Victimele unor astfel de politici au fost în cele mai multe cazuri statele mai mici și mai slabe.

Interferența în problemele interne este de obicei realizată prin mijlocul presiunii directe sau indirecte asupra altor țări.

De aceea, în ultimele decenii, și mai ales în anii care au urmat celui de-al Doilea Război Mondial, s-a preocupat de dezvoltarea unor texte normative care să interzică intervenția în problemele altor țări. Astfel, pentru exemplu, art. 1 al Convenției Internaționale privind Drepturile Civile și Politice, un text identic cu art. 1 al

International Covenant of Economic, Social and Cultural Rights, adopted by General Assembly Resolution no. 2200 / XXI of 16 December 1966 reads:

„1. All peoples have the right to decide their own destiny. By virtue of that right they freely determine their political status in and pursue freely their economic, social and cultural

2. All peoples may view their own ends, freely dispose of their natural wealth and resources without prejudice to any obligations arising out of international economic cooperation based on the principle of mutual benefit, on international law. in any case, a people be deprived of its own means of subsistence [11].

3. States Parties to the present Covenant, including those having responsibility for the administration of territories and territories under trusteeship, will promote the realization of the right to self-determination, and shall respect that right, in conformity with the Charter of the United Nations.

Although the noninterference in another state principle and fundamental norm of international law faces difficulties and obstacles in practice, it gradually continued to make his way and in a short time will be recognized [12], ie become mandatory for all states, not only *de jure* but also *de facto*.

#### **4. Noninterference in internal affairs of other states**

Under public international law the principle of sovereignty, States have a reserved area of competence [13].

International jurisprudence considers the exclusive competence of States as the capacity that they have to decide in a sovereign manner in areas of interest that do not belong to the Public International Law [14].

Thus, by the concept of sovereignty, it is considered that no State has the right to interfere in the internal affairs of another State competent to resolve their own problems occurring in its own territory and in relation to its nationals.

The right of peoples to dispose of themselves refer to peoples and not national minorities and other minority groups - through their very nature, they live in an area with a different ethnically, linguistically or

religiously majority[15]. For these minority or groups this is not a question of self-determination, but of the exercise of human rights, including the rights of specific language, culture, religion and preserve their own identity.

#### **4.1. Noninterference in internal affairs of other states on humanitarian grounds**

Protection of human rights has its roots in the distant ancient Greek institutions [16].

The vast process of affirming the human rights of minorities and that more active involvement of the international community aimed at compliance issues worldwide represent a development most distinctive and notable in the contemporary world [17].

Politically, the country which would violate those rights is virtually isolated from the international community, which nowadays increasingly rejects more practices of arbitrary despotism, use of force against opponents.

However, use of force to interference in internal affairs of a state for humanitarian reasons, is not the lawful solution of these problems. Humanitarian problems can only be solved by concerted action of the international community, through coercive measures against the state that violates international law but, in any case, not through measures that would directly affect the independence and sovereignty of the State.

International recognition of human rights meant the assumption of international obligations for the member States of organizations of this scale - mechanisms and specialized agencies of the United Nations and regional intergovernmental organizations [18].

With the entry into force of the European Convention on Human Rights and Fundamental Freedoms, the individual becomes the subject of international law and can be equal to the state in international relations [19]. Also, from now on states can not easily prevail on the principle of non-interference in internal affairs, to treat their citizens discretionary. This position of the individual was strengthened by the International Covenant on Civil and Political Rights.

## 5. Conclusions

Formal treaties, binding and declarations, resolutions and international conferences, have shown that both traditional view of noninterference, where intervention based on the use of force or the threat of this kind, and broad vision of non-interference, characterized by the use of mechanisms without the use of force are prohibited. Conventional together with customary law of the twentieth century highlights the importance and need for the principle of non-interference in the internal affairs of other states in order to ensure sustainable development of international society .

The principle of noninterference in internal and external affairs, prohibition of all interference with the internal affairs of states and peoples without exception are enshrined in treaties of friendship and solemn declarations signed by Romania at the highest level

## 6. References

- [1] Anechitoae C. *Elements of international law I*. București, Bren, 2010, pp. 83-85; Anechitoae C. *Geopolitics of maritime systems* . București, Ed. Militară & Top Form; Anechitoae C. *Introduction to international maritime law*. București, Bren, 2011.
- [2] Năstase, A.; Aurescu, B.; Jura, C. *Public International Law . Ediția 4*. București, C. H. Beck, 2006, p. 64.
- [3] Dominique, C. *Droit international*, Pedone, Paris, 2004.
- [4] Chirtoacă, N. *Strengthening the international principle of non-interference in the twentieth century conventional and customary law* . Revista Moldovenească de Drept Internațional și Relații Internaționale, Nr. 1(27)/2013, pp. 5-17.
- [5] Scăunaș, S. *Public International Law. Ediția 2*. București: C.H. Beck, 2007, p. 54.
- [6] Mazilu, D. *Peace law. Treaty* All Beck, București, 1998, pp. 169-173.
- [7] League of Nations, *Convention of the League of Nations*, Paris, 1919, Articolul 15 (8).
- [8] Sumner Welles, *Intervention and Interventions*, Foreign Affairs, Vol. 26, No. 1, 1947-1948, p. 120.
- [9] Fawcett, J. *Intervention in International Law*, în R.C., 1961, vol. II, 103, p. 353-354.
- [10] Mazilu, D. *Public International Law Vol. 1*. Lumina Lez, București, 2001, pp. 205-208.
- [11] *Economic and technical cooperation among developing countries*, A52/630 of 18 December 1997.
- [12] Geamnu, G. *Contemporary international law , ediția a II-a, vol. 1*. Editura Didactică și Pedagogică, București, 1975, pp. 209-210.
- [13] Floriu, M. *Concepts of public international law* Editura Didactică și Pedagogică, R.A., București, 2013, p. 43.
- [14] Dupuy, P. M. *Droit international public*. Dalooz, Paris, 2004.
- [15] Diaconu, I. *Course of International Law* Casa de cultură și presă Șansa SRL, București, 1993, pp. 281-283.
- [16] Ţenekides, G. L'action des Nations Unies contre la discrimination raciale. Recueil des cours de l'Academie de droit international de la Haye, t. 168, 1980 – III, p. 303.
- [17] Ecobescu, N.; Duculescu, V. *Drept internațional public*. Hyperion XXI, București, 1993, p. 168.
- [18] Zlătescu Moroianu, I. *Human rights - an evolving system*. I.R.D.O., 2008, P. 35.
- [19] Balahur, D. *European protection of human rights. Course support* . Universitatea „Alexandru Ioan Cuza – Iași. Centru de Studii Europene, p. 4. [http://www.cse.uaic.ro/\\_fisiere/Documentare/Suporturi\\_curs/III\\_Protectia\\_europeana\\_a\\_dr\\_omului.pdf](http://www.cse.uaic.ro/_fisiere/Documentare/Suporturi_curs/III_Protectia_europeana_a_dr_omului.pdf)
- [20] Căzinel, M. *Comparative Analysis between the Exception otu ysn-performance of the Contract and the Lien - Similarities*, Analele Universitdlii Ovidius, Seria Știinie Economice, volumul XV, issue 1, Year 2015.

# The Structure-Performance Relationship In Romanian Banking System

Claudia Dobre  
*Universitatea Ovidius Constanta)*  
[dobre\\_claudia@yahoo.com](mailto:dobre_claudia@yahoo.com)

## Abstract

*First, in this study we try to highlight the evolution of the banking system concentration in Romania for 2001 – 2011, taking into account the values of market share of the top five (CR5) and Herfindahl-Hirschman Index (HHI). Novelty of this study is that it aims to test whether the Structure-Conduct-Performance Paradigm holds by investigating the relationship between concentration and banking system performance in Romania. We observed that the competition in the Romanian banking system increases continuously in the last years, but the Romanian banking sector remain relatively concentrated, according to the value of CR5. We find that is a positive correlation between market concentration and performance in Romanian banking, according to the Pearson's correlation coefficient.*

**Keywords:** concentration, bank competition, the SCP Paradigm

**JEL Classification:** G21, L11

## 1. Introduction

The financial sector is special. Banks perform intermediation functions that are critical to the real economy and that facilitate and contribute to the growth of the economy. Linkages between banks through inter-bank markets and payment systems are vital to the functioning of financial markets [1]. As in most sectors of the economy, the benefits of full, effective competition in the financial sector are enhanced efficiency, the provision of better products to final consumers, greater innovation, lower prices and improved international competitiveness. Theoretical results demonstrate that monopolistic market power of banks increase the opportunity costs of capital and thus, tends to make financing

more expensive. Lack of adequate competition in banking could thus, adversely affect economic development. The implication for competition policy is that higher market concentration is associated with lower socio-economic welfare and, therefore, higher concentration is undesirable.

The present analysis is based on panel data collected from NBR, BCE and BSCEE for Romania banking system between 2001 and 2011. Novelty of this research is that we apply the Structure-Conduct-Performance (SCP) hypothesis from the Industrial Organization literature to examine whether market concentration has an impact on Romanian banking performance. Should be said from the beginning that we do not take explicit account of the conduct of banks and the analysis undertaken focus on the structure – performance (S-P) relationship. Our empirical approach integrates a panel data analysis regarding indicators of banking sector concentration (CR5 and HHI) and of banking performance (ROE) from Romania banking system during 2001-2011 and calculation of Pearson's correlation coefficient between structure indicators and performance indicator for the period mentioned.

## 2. Literature Review

Gilbert surveyed 56 studies on market structure and competition and find that most of the studies used concentration in local market areas as a relevant measure of the banking market structure [2].

As a matter of public policy, the measurement of market concentration is important and lies at the heart of decisions about whether to approve mergers and acquisitions that might pose a potentially harmful impact on consumers in terms of both prices and the availability of goods and services. These issues have been addressed

by antitrust laws in the U.S. dating to the Sherman Antitrust Act in 1890. Unlike, it was not until 1989 that EU Policy makers realized the usefulness and the necessity of a common merger regulatory framework, and responded with the European Council Merger Regulation (ECMR) on the control of concentrations, forced by the increased cross-border activities of European firms in the second half of the '80.

The research on bank competition has evolved mainly in two directions: the structural and nonstructural approaches (in Europe structural factors appeared to be more important and the SCP hypothesis seemed to hold). The SCP paradigm investigates whether a highly concentrated market causes collusive behavior among larger banks resulting in superior market performance. Continuing the same idea, SCP paradigm suggests that higher concentration leads to higher prices which lead to higher financial returns.

In the context of banking, the studies generally examined concentration issues in the context of overall Structure-Conduct-Performance relationship (SCP). It is only since about 1960 that we have seen a growing body of empirical work dealing with market structure and its impact on bank performances. Further a number of studies (Berger and Hannan (1989), Hannan (1992), Neumark and Sharpe (1992), Okeahalam (1998) Prager and Hannan (1998) support the SCP framework. They find positive relationships between market structure and bank performance measures. This foundation has been supported over 20 empirical works.

Recent research has however indicated that the relationship between competition and banking system performance is more complex and that the view that competition is unambiguously good is more naive in banking than in other industries.

Corvoisier and Gropp show that for demand deposits and loans, increasing bank concentration in Euro area countries during the years 1993-1999 has resulted in less competitive pricing by banks [3]. This finding supports the SCP hypothesis. However, for time deposits and savings, the more concentrated the market, the lower the bank margins. This result contradicts the SCP model.

However a number of other empirical studies, for example Shaffer (1989) cast doubt on the SCP findings. James Nguyen suggests that concentration plays an unimportant role in bank profitability [4]. This result does not support the SCP hypothesis which implies a positive relationship between concentration and profit.

Many other works have found insignificant relationships between the measures of market structure and of bank performance. This achievement has been advocated by over 15 empirical works, such as Flechsig (1965), Murphy (1971), Osborne and Wendel (1981) and Smirlock (1983 and 1985).

### 3. Data Base And Methodology

Since we are interested in the behaviour of banks, it is natural to adopt a panel approach. In this study, we examine bank performance through market structure. Our empirical approach integrates a panel data analysis regarding indicators of banking sector concentration (CR5 and HHI) and of banking performance (ROE) from Romania banking system during 2001-2011. In order to capture the evolution of market concentration and performance, we used data provided by BSCEE [5] NBR [6] Stability Reports, and BCE. The Group of Banking Supervisors from Central and Eastern Europe (BSCEE) was established in 1991 and his publication gives an overview of the macroeconomic circumstances in the twenty one member states, and it describes the banking sector as well as the supervisory activities.

Using the data obtained, we plotted the evolution of CR5, HHI and ROE, analyzing the correlation between these indicators and further calculating the Pearson correlation coefficient.

#### *Indicators of market structure*

The concept of market concentration has been comprehensively treated and debatable in the economic literature. Despite the several various approaches related to its measurement, the principal elements of concentration measures are number of banks and the distribution of bank size in a given market. Structure – Conduct – Performance

(SCP) paradigm can be based on any concentration ratio.

The structure indicators used in the present study are:

a) Concentration Ratio (CR5): Five-Bank concentration ratio equals to the sum of the assets, or deposits, of the largest five banks in a given market divided by the total assets of that market, as in equation:

$$CR5 = \frac{\text{The Largest Five Banks' Assets}}{\text{Market's Assets}}$$

Above review of literature gives us the empirical substance to one of the theoretical advantages which is claimed for concentration ratios as a measure of market structure. Since the importance of concentration ratios arises from their ability to capture structural features of a market, these are therefore often used in structural models explaining competitive performance in the banking industry as the result of market structure. Concentration ratios are also able to reflect changes in concentration as a result of the bank's entry into the market or its exit from it, or caused by a merger.

b) Herfindahl-Hirschman index (HHI)

It consists of the sum of squares of firm sizes, all measured as percentages of total industry size.

$$HHI = \sum(S)_i^2$$

where S is the proportion of market share for the *i*th firm. Scale goes from zero to 10.000, with 10.000 indicating that a single company controls 100% of the market share in a given industry.

A market share is the fraction or percentage of a relevant market controlled by a specific market participant. Market shares can be calculated based on: sales revenues; capacity and units. Therefore, market share calculations permit courts and agencies to determine how many sales the defendant will lose if it raises prices. The greater the firm's market share, the less likely that other firms will be able to enlarge production to defeat the unilateral price increase.

The HHI index was originally proposed and used in the field of industrial economics by Herfindahl (1950) and Hirschman (1964) independently of each other. For the first time, in 1982, the Department of Justice in US replaced the standard four firm concentration index (C4) with the Herfindahl-Hirschman index (HHI). Since then, the HHI has been used in the analysis of

horizontal mergers in which parties combine their productive capacities in a relevant market to operate as a single firm. Whereas C4 adds up the market shares of the top four firms to calculate industry concentration, HHI is more complete and elaborate in that it uses a weighted average of market shares of all firms.

Unlike the concentration ratio: HHI reflects the degree of market share inequality across the spectrum of firms that participate in a market. The influence of smaller firms is lessened. The influence of larger firms is emphasized. Thus, higher values of the HHI reflect the combined influences of both unequal firm sizes and the concentration of activity among a few large firms.

Although it is best to include all firms in the calculation, lack of information about very small firms may not be important because such firms do not affect the HHI significantly.

The HHI-Index provided some useful insights into market concentration in Irish banking. The Index summarizes, inter alia, the effects on market structure of changes both in the number as well as the size distribution (deviation from average bank size) of all banks. The inverse of the Index gives the number of equal-sized banks equivalent to a particular value for the Index, which enables policy-makers to see at a glance the direction in which market structure is changing.

#### *Performance indicator*

a) Return on Equity (ROE)

Bank performance may be measured by Returns on Assets (ROA), or Return on Equity (ROE), or interest rate charged on loans or that paid on deposits. Indicator of profitability, ROE is determined by dividing net income for the past 12 months by common stockholder equity (adjusted for stock splits). Result is shown as a percentage. Investors use ROE as a measure of how a company is using its money.

ROE is an internal performance measure of shareholder value, and it is by far the most popular measure of performance [7], since: it proposes a direct assessment of the financial return of a shareholder's investment; is easily available for analysts, only relying upon public information; it allows for comparison between different countries.



*The Correlation Coefficient (Pearson's r)*

It measures the linear relationship between two interval/ratio level variables.

$$r_{yx} = \frac{\text{cov}(y,x)}{\sqrt{\text{var}(y) * \text{var}(x)}} = \frac{\sum(X_i - \bar{X})(Y_i - \bar{Y}) / N}{\sqrt{\sum(X_i - \bar{X})^2 \sum(Y_i - \bar{Y})^2 / N * N}} = \frac{\sum(X_i - \bar{X})(Y_i - \bar{Y})}{\sqrt{\sum(X_i - \bar{X})^2 \sum(Y_i - \bar{Y})^2}}$$

where: Cov(y,x) = the covariance of y and x, Var(x)= the variance of x, Var(y)= the variance of y

Pearson's r coefficient of correlation can have a value anywhere between -1 and 1. The larger is the coefficient, ignoring sign, the stronger the association between the two variables. At its extreme, a correlation of 1 or -1 means that the two variables are perfectly correlated, meaning that you can predict the values of one variable from the values of the other variable with perfect accuracy. At the other extreme, zero implies an absence of a correlation - there is no relationship between the two variables. This implies that knowledge of one variable gives you absolutely no information about what the value of the other variable is likely to be. The

sign of the correlation implies the "direction" of the association. A positive correlation means that relatively high scores on one variable are paired with relatively high scores on the other variable, and low scores are paired with relatively low scores. On the other hand, a negative correlation means that relatively high scores on one variable are paired with relatively low scores on the other variable. The Pearson correlation cannot determine a cause-and-effect relationship. It can only establish the strength of the association between two variables.

Further for the purpose of study, we have centralized in a table the data on the structure indicators: the share of top 5 banks and HHI and on the performance indicator: ROE for the period 2001-2010 for the Romanian banking system:

**Bank concentration and performance in Romania**

	2001	2002	2003	2004	2005	2006	2007	2008	2009	2010
Market share of the top five banks in total assets (%) - CR5	66,1	62,8	63,9	59,2	58,8	60,3	56,3	54,3	52,4	52,7
Herfindahl-Hirschmann index - HHI	1.427	1.381	1.264	1.120	1.124	1.171	1.046	926	857	871
Return on Equity - ROE	21,38	18,27	17,72	16,79	12,64	10,41	9,4	17,04	3	-2,4

Source: NBR 2011, BSCEE Review 2001-2010

**4. Results**

As we can see in the Table 1, the concentration of the Romanian banking system has been decreasing continuously from 2001 to 2010. Both indicators of market concentration have declined: CR5 from 66,1 in 2001 to 52,7 in 2010 and HHI from 1427 in 2001 to 871 in 2010. The Romanian banking sector remain relatively concentrated. Top-five banks (in terms of assets) held in 2010 52,7 percent of aggregate assets on the credit institutions' balance sheets. Herfindahl-Hirschmann index was in

decline since 2006, indicating a moderate degree of concentration (value of 895 points recorded in June 2011 places the Romania under 1102 points recorded average EU).

This means that the competition in the Romanian banking system has increased yearly, especially due to diminishing of the state capital and entering of foreign capital. The main factors which have influenced this process were: the privatization of the majority of state capital banks and the perspective of accession of our country in the EU. In the first period of transition of Romanian economy banks have had very

good performances due to their market share in a low competitive banking environment.

Also the performances indicator declined, being closer to the average value of this indicator. As we can see in table 1, at end-2008, the key profitability indicator ROE showed a significantly higher level 17,04% due mainly to the sale of participating interests held by four banks in the equity capital of an insurance company, on the one hand, and to the higher net interest income, on the other hand.

After a solid financial performance during the boom years, mainly due to large profits generated by intense credit activity, the Romanian banking sector was put under stress in 2009. Although the banking sector has been resilient to the crisis so far, the financial results are significant lower comparing with the similar period of the previous year. The banking system ended 2009 with profit (net profit of 816 million lei) and despite the unfavourable context on the global and local market, the Romanian banking system succeeded to preserve the positive trend in terms of profitability even in the first quarter of 2010 (net profit of 440 million lei) [8].

As of 31 December 2010, the Romanian banking sector consisted of 33 local

incorporated credit institutions and 9 branches of EU foreign credit institutions. Among the local credit institutions 26 entities have majority foreign capital, while other 7 credit institutions have majority domestic capital (2 state-owned credit institutions and 5 private-owned credit institutions). Consequently, foreign owned credit institutions held the largest share in the total banking system assets (85.1%, including foreign banks branches) followed by the domestic private-owned credit institutions with 7.5% and domestic state-owned credit institutions with 7.4% [7]. Profitability of Romanian banking system went into negative territory since May 2010. For the first time since 1999, the banking system ended the year with loss, mainly influenced by the high cost of provisioning, but also because the damage in the operating result. In the case of ROE, it continued the downward trajectory in 2010 for the second consecutive year.

In the graph below, comparing the indicators of market concentration (CR5 and HHI) with the performance indicators (ROE) we see that there is a positive correlation between market concentration and performance in Romanian banking system until 2007. The closest correlation is recorded between CR5 and ROE.

**Figure 1: Evolution of CR5, HHI and ROE for Romanian banking system**

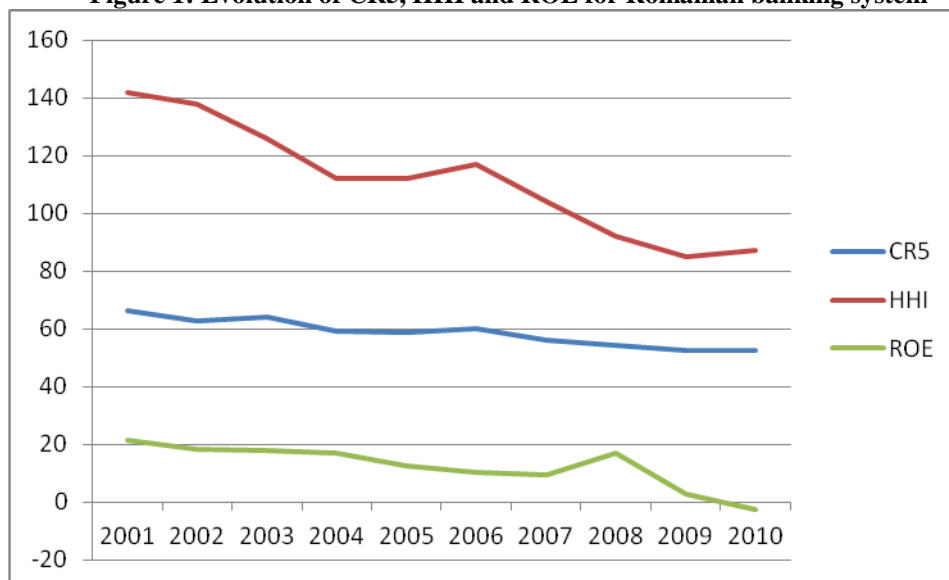

Source: author, data provided by NBR 2011, BSCEE (2001-2010)

Further, applying the Pearson's coefficient of correlation to the indicator of market structure CR5 and the indicator of performance ROE for the period 2001-2010 we obtained the following value:

$$r = 0,788930386$$

Using the same calculation, but comparing the evolution of HHI and ROE, the result is:

$$r = 0,774157776$$

These values, relatively close, suggest a positive correlation between market

concentration and performance in Romanian banking system (the same conclusion as graphical analysis). Therefore, the SCP paradigm holds when we analyze the impact of market structure (through HHI and CR5 indicators) on Romanian banking system performance (expressed in our study by ROE indicator).

As we see from the chart above, since 2007 the correlation between the indicator of market concentration and the indicator of performance is not so close. Therefore, we calculate the Pearson coefficient separately

**Tabel 2: The Pearson`s coefficient of correlation**

Indicators	2001-2010	2007-2011
CR5 - ROE	$r = 0,788930386$	$r = 0,601894348$
HHI - ROE	$r = 0,774157776$	$r = 0,499592939$

We can conclude that there is a medium positive correlation between market concentration and performance of Romanian banking system between 2007-2010, compared with the strongest positive correlation for the period 2001-2010.

This weakening of the correlation is due to the sale of participating interests held by four banks in the equity capital of an insurance company and to the higher net interest income in 2008 and due to the high cost of provisioning and the damage in the operating result after 2008, under the influence of financial crisis.

## 5. Conclusions

The competition in the Romanian banking system increases continuously in the last years. This conclusion is supported by decreasing evolution of the two indicators of market concentration: CR5 and HHI, during 2001-2011, but the Romanian banking sector remain relatively concentrated, according to the value of CR5. Since the market structure in Romanian banking system is still relatively concentrated, public policy should focus on increasing competition such as discouraging mergers and acquisitions.

An important finding from this study is that bank concentration has a significant impact on bank performance in Romanian banking sector.

The structural measures are only a first step in analysing whether concentration will

for the period 2007-2011. It takes the following value when we compare CR5 with ROE:

$$r = 0,601894348$$

and for the correlation between HHI and ROE, the Pearson`s coefficient for the period 2007-2011 is:

$$r = 0,499592939$$

Further, in order to draw conclusions about the evolution of the three indicators that we have study, we centralized in a table the Pearson`s correlation coefficient values recorded:

create or enhance the exercise of market power. Market contestability is therefore important for evaluating competition in financial markets. Furthermore, factors such as switching costs, geographic constraints on customers or supplies, competition from non financial firms, and the size of competitors and customers need to be considered.

## 6. References

- [1] OECD, 2009. Competition and Financial Markets, Series Roundtables on Competition Policy, No. 92. OECD, Paris
- [2] Gilbert A, 1984. Bank Market Structure and Competition: A Survey, Journal of Money, Credit and Banking, vol. 16, No. 4, Part 2: Bank Market Studies
- [3] Corvoisier S. & Gropp R., 2002. Bank concentration and retail interest rates, Journal of Banking & Finance, Elsevier, vol. 26 (11)
- [4] Nguyen J., 2011. Market Concentration and other Determinants of Bank Profitability: Evidence from Panel Data, International Research Journal of Finance and Economics, Issue 70
- [5] BSCEE, 2010. BSCEE Review
- [6] NBR, 2011. Report on financial stability
- [7] European Central Bank, 2010. Beyond ROE – how to measure bank performance, 2010
- [8] BSCEE, 2009. BSCEE Review
- [9] Majid M.-Z.A. & Sufian F., 2007. Market structure and competition in emerging market: evidence from Malaysian islamic banking industry, Journal of Economic Cooperation, 28, 2

## IT&C - A Job-Creating Industry during Crisis

Ilie Constantin Florea

*The Bucharest University of Economic Studies*  
[costi.florea@gmail.com](mailto:costi.florea@gmail.com)

### Abstract

*The IT&C industry (Information Technology and Communications) makes Romania one of the main attractions among European countries, and this industry is considered by the authorities as strategic for the development of the national economy because of its potential to generate economic growth, modernize the society and create new jobs each year.*

*The global financial crisis may have hit the Romanian economy hard, but one sector has managed to recover after the shock before all the others. Many casualties appeared in the real economy during recession (not just in the financial sector), but the IT&C sector continued to employ a larger number of professionals year after year. It was truly the golden sector of the economy.*

*This paper analyzes the local IT&C industry (in particular the software and services sector) and compares it with the global perspectives in order to better paint the picture of a job-creating industry during crisis.*

**Key words:** Information Technology, Job Creation, Innovation

**J.E.L. classification:** L86

### 1. Introduction

The management of information has become today one of the hottest and most difficult to master things in people's lives. We have had many discoveries contributing to the evolution of the humanity (like written language, the arithmetic operations or the invention of printing), but nothing can be compared with the last 50 years in which media and electronic communications have become commonplace and have changed the way we live and do business. [1]

With the abundance of information surrounding us comes the necessity to better manage it in organizations and in the society as a whole. From 1990s, the connection between science, technology and economic performance seems to have changed and innovation has become more critical to the success of companies all over the world. And one sector which facilitated innovation more than others is the IT&C one. [2]

In the Oxford Dictionary, Information Technology (IT) refers to the study or use of systems (especially computers and telecommunications) for storing, retrieving, and sending information. [3]

In the following sections, we will analyze the Romanian IT&C industry, as well as the international market, in order to better understand their evolution during the recent global crisis. The analysis will show that this industry has continued to create jobs during difficult times of the economy, contributing to the evolution of the society in all aspects.

### 2. Overview of the Romanian IT&C industry

Historically, the IT&C sector has been the best student of the Romanian economy over the decade starting in 2001 and ending in 2010, with annual growth rates of over 20% in eight consecutive years according to the Romanian Institute for Computers. These average growth rates have made the Romanian market attractive for multinational corporations, who have invested massively.

Among the criteria chosen when deciding to do business in the Romanian IT&C sector, we can enumerate: reduced costs of the labor force, technology expertise, previous sector experience, language proficiency, seriousness in implementing new projects and procedures, solid control on all aspects of the business (financial, coordination, information systems), mentality and cultural characteristics (close to the Western

mentality in achieving results, good communication and easiness in building relationships).

Even though Romania cannot challenge larger countries (like China, India, and Russia) at the volume of the IT&C activities, the proximity to Western Europe, its membership to the European Union, and the possibility to quickly learn and adapt new technologies (through well-organized methodologies) makes the local market very attractive to foreign investors.

One important advantage of the Romanian staff (in comparison with similarly specialized professionals from more developed countries) is the customer-oriented attitude – which brings quality and value to foreign companies, not to mention more customer satisfaction (independent of the culture of clients). Finally, the possibility to grow at a fast pace with limited initial investments is without doubt the main incentive for potential investors (Romania

actually tops the 2011 Deloitte Technology Fast 50 rankings, a program which recognizes the fastest growing companies in Central and Eastern Europe). [4]

Undoubtedly, the economic crisis has had an important impact on the IT&C sector (especially in what the implementation of new projects is concerned), but the companies have adapted well to the external changes, and have continued to bring considerable profits. The contribution of the IT&C industry to Romania's GDP had been at 5% in 2007 and slowly decreased to 4.4% in 2010 (with no significant change from the previous year). [5]

The revenues of the IT&C industry have shown a strong recovery in 2010 (reaching the levels before the economic crisis, at around EUR 9 billion). At the same time, the software and services sector has reached around EUR 2.6 billion (Figure 1).

Figure 1: Revenues and sold production of the software and services industry (EUR million)

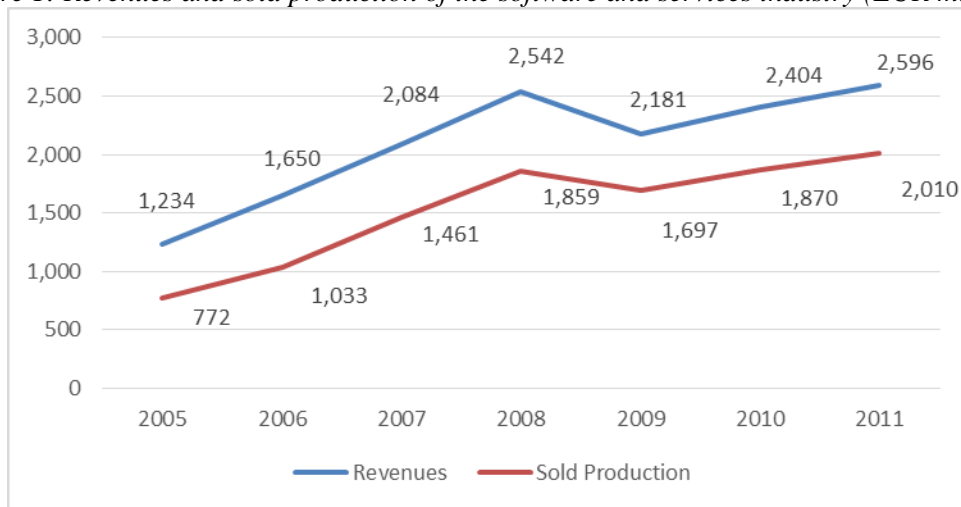

Source: Romanian Institute for Computers [6]

A clear indicator of the strong performance of the IT&C industry has been the positive trend in exports, which was not interrupted by the economic downturn (+30% in 2010 vs. 2009, hardly matched by any other sector in the economy). At the same time, the software and services sector registered steady profits throughout the hardest times of the crisis: from EUR 154 million in 2005 to EUR 177 million in 2011 (as shown in Table 1).

Table 1: Net profit of the software and services sector

Year	Net Profit (EUR mil)
2005	154
2006	198
2007	210
2008	190
2009	162
2010	167
2011	177

Source: Romanian Institute for Computers [6]

The total personnel employed in IT&C activities has increased from 101,191 in 2005 to 119,105 in 2011 (+17.7%), and this industry is expected to create around 7% of new jobs each year from 2011 to 2013 – thus becoming the most active market in what the labor force is concerned. The software-related businesses are the only ones which

have managed to increase their staff during the economic downturn and will continue to do so in the years to come.

After a decrease of 5% in 2009, the average salary in the industry has had a positive trend in 2010, reaching a value of around EUR 800 per month (+10% with respect to the previous year, which is again a good indicator of the resilience of this sector in front of the economic crisis). [5]

Figure 2: Number of companies and personnel in the Romanian software and services sector

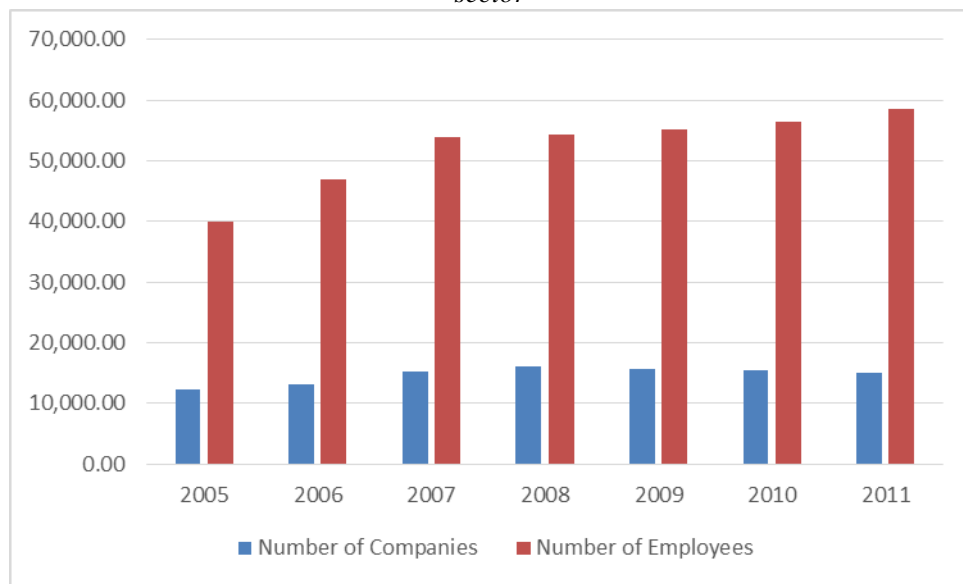

Source: Romanian Institute for Computers [6]

An imminent consequence of the international economic climate has been a temporary decrease of the stocks of Foreign Direct Investments (FDIs) in the Romanian IT&C industry. Even though the total of FDIs has increased year after year during crisis (showing that Romania remained an important country in the region), the IT&C sector suffered in terms of new projects and saw its investments reduced by 8.85% in 2008 compared to 2007 and by 4.76% in 2010 with respect to the previous year (Figure 2). The lack of liquidity on the market, the increased perception of risk regarding the emerging countries, and the overall turmoil have brought also a strongly reduced value of green field investments in Romania (less than 1% of the total FDIs). This indicator is very important for the IT&C industry, since the startups are the most important sources for growth and creation of jobs in this sector.

In what the hardware activities are concerned, the FDI stock has remained constant over the recent years of crisis, at around EUR 690 million. [7]

### 3. Issues and opportunities in the Romanian IT&C industry

One of the main issues of the local IT&C market is that the internal demand is still insufficient to support its growth, and the recent years of crisis have shown us that the society is not fully prepared to absorb the majority of the products and services developed in Romania. The IT&C industry has managed to escape important losses due to exports and the production made for multinational corporations.

The level of using e-commerce is still low in Romania, compared to the European average; according to several studies, e-buyers represent less than 30% of the online

population. The main concern of the potential clients is the risk taken when making payments on the Internet, and the lack of information on the real products comes in second; however, since the population has a positive attitude towards shopping, this sector is expected to make progress in the years to come (if the overall state of the economy ameliorates). The success marked by the biggest online store in Romania (www.eMag.ro) is promising for the future of this market.

Another issue is represented by the fact that the net inflow of FDIs in Romania has decreased considerably in the past years, and this puts in danger a lot of new projects and the creation of new startups (which could, in turn, help the economy by creating jobs and registering high growth rates). Some of the new investments have been put on hold in major technological centers, and this could have an impact on the long run (in what the business climate is concerned).

Figure 2: FDIs in Romania (EUR million)

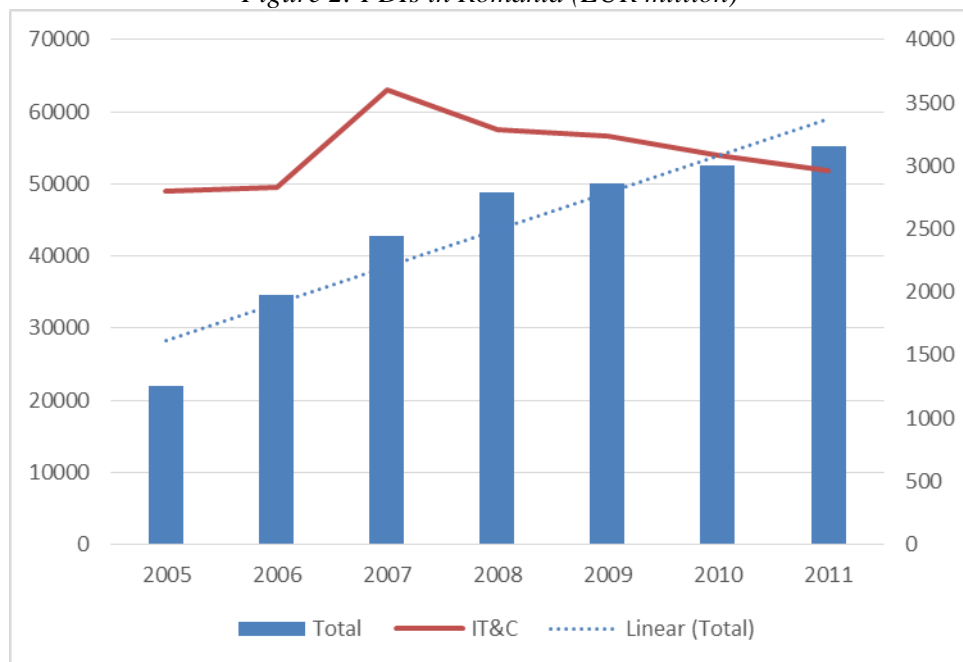

Source: National Bank of Romania [7]

However, there are plenty of opportunities. As one of the youngest members of the European Union and representing a traditional form of society, there is an important potential for growth in the Romanian IT&C industry. The interest given by the Romanian authorities to modernize their institutions and facilitate the access to information through technology is very high, and there are a number of projects that could be developed with the state or other local institutions. The Romanian consumers are also very opened to new products and innovations for the IT&C sector; the use of smart phones, pads, laptops, e-book readers or ultraportable computers is still limited in Romania, but the potential for low cost versions of these products is very high.

Mass technology is an important objective for the global companies working in this field of activity, and the Romanian companies will adopt the same trend in the years to come (we will see in the next 5 to 10 years a continuous process of integration of the new technologies in the Romanian society, but the speed of this process will be highly dependent on the overall evolution of the economy).

The presence of important international actors and brands in the local market makes possible the creation of an appropriate ecosystem in which the activity can ensure its continuation (e.g. the General Manager of Microsoft Romania estimates that for every RON made by its company in Romania, other firms from the local ecosystem make six times as much).

A niche segment for the IT&C sector could be represented by the education system (namely academic institutions – which are integrating new technologies at a relatively high pace), and cultural institutions. The Ministry of Communications and Information Society also intends to develop a national Computer Emergency Response Team in order to prevent and manage natural and technological disasters.

#### 4. International market

The global software & services industry had total revenues between USD 2,000 billion and USD 2,600 billion during the period 2008 – 2012, representing a compound annual growth rate (CAGR) of 4.8% between these years. The two most important segments of this industry were the IT one (48.3% of total in 2012) and the Internet Software and Services (40.3% of total in 2012). The overall industry is expected to grow as well in the years to come, reaching a high of USD 3.2 trillion in 2017. [8]

The international IT market has grown considerably during the last decade, with few adverse movements. Not only have the IT corporations changed the way corporations do business (in terms of productivity through automatic systems), but they have also transformed the way we access and manage information as individuals. IT is considered by some researchers to contribute to around 25% of the European Union's growth in GDP. At the same time, despite the unfavorable global economic climate, digitization (which can be defined as the mass adoption of connected digital services by economic agents) provided a US\$193 billion boost to world economic output and created 6 million jobs globally in 2011. [9]

So not only in Romania, but also all over the world, the IT industry facilitated innovation and the creation of new jobs.

#### 5. Conclusions

Information Technology has become a very important part of the global economy in the context of globalization and standardization of markets. We need to control information just like we need to control everything in our lives, and IT has

become the driving force of innovation and transformation in Europe and all over the world. In the era of hyper-connectivity, every organization is in the hunt for new technologies and systems.

In Romania, the software and services industry is probably the only sector of the economy which constantly created new jobs during crisis. Year after year, even though new projects were blocked and green field investments were diminished, the software and services sector managed to increase the number of people employed in its organizations. This shows that the industry not only serves the society by changing it through innovation but also helps increase the living standard of its people by employing new personnel.

If other sectors (like the financial one) have socialized their losses during crisis, the IT sector continued to grow with the society. This gains trust on the market and increases the popularity of IT corporations among their consumers and among their business partners. These corporations focus on people, as the human factor is very important in the design and application of information technology; this way, the future, shaped by people, belongs to IT evolution.

#### 6. References

- [1] Charlton, M., *A Handbook of Information Technology*, Global Media, Delhi, 2009.
- [2] OECD, *A New Economy? The Changing Role of Innovation and Information Technology in Growth*, Organization for Economic Cooperation & Development, Paris, 2000.
- [3] Oxford Dictionary, <http://www.oxforddictionaries.com/definition/english/information-technology?q=information+technology> [Accessed on November 5, 2015]
- [4] Deloitte Technology Fast50 Central Europe 2011, [http://www2.deloitte.com/content/dam/Deloitte/global/Documents/About-Deloitte/2011\\_CE\\_Technology\\_Fast\\_50.pdf](http://www2.deloitte.com/content/dam/Deloitte/global/Documents/About-Deloitte/2011_CE_Technology_Fast_50.pdf) [Accessed on November 5, 2015]
- [5] INSSE, <http://www.insse.ro/cms/ro/content/produsul-intern-brut> [Accessed on November 5, 2015]
- [6] ITC, Romanian Institute for Computers <http://www.itc.ro/index.php?lang=2> [Accessed on November 5, 2015]
- [7] National Bank of Romania, <http://www.bnr.ro/Home.aspx> [Accessed on



November 5, 2015]

- [8] Rangarajan, K., Tiwari, S. K., *Evolution of Global IT Services Industry: Impact of Technological advancements and Business needs*, IOSR Journal of Business and Management, Vol. 16, Nr. 5. Ver. I, pp. 33-40, 2014
- [9] Sabbagh, K, Friedrich, R, El-Darwiche, B, Singh, M, Koster, A, *Digitization for Economic Growth and Job Creation: Regional and Industry Perspectives*, Booz & Company, 2013

## When Companies Become Too Socially Innovative to Fail

Ilie Constantin Florea

*The Bucharest University of Economic Studies*

[costi.florea@gmail.com](mailto:costi.florea@gmail.com)

Marc Sommer

*The Bucharest University of Economic Studies*

[m.sommer@outlook.com](mailto:m.sommer@outlook.com)

### Abstract

*If there was still a doubt, the recent global crisis proved to everyone how well interconnected the components of the financial system are. What started as a financial crisis soon became a problem for the entire economy. The snowball effect caught many sectors of the real economy and authorities had to intervene to save companies from bankruptcy.*

*Not only the financial sector benefited from the government's support, but also the auto industry. This led analysts to ask themselves why multinational corporations (MNCs) are bailed out when individuals receive no support in case of financial difficulties. Should companies be allowed to grow so big that they cannot fail? If market competition is left untouched, companies should be more concerned to become not too big but too socially innovative to fail.*

*The recent global crisis is an opportunity for companies to change their way of doing business and refocus on people.*

**Key words:** Global Crisis, Banking, Social Innovation

**J.E.L. classification:** G01, G21

### Introduction

After the recent crisis, we have gained new words in our everyday vocabulary, like 'subprime lending', 'toxic assets' and 'credit crunch'. These words come from finance and if we have learned anything from the recent events is that finance has become one of the most important sectors in the economy and in our lives. Unfortunately, these new words

have bad connotation; but not everyone had a rough time during the crisis. Some companies succeeded in maintaining healthy levels of profits during 2008 and 2009, and continued on a positive trend afterwards.

These companies have managed to innovate beyond the maximization of profits and focus on the people and the communities in which they operate.

### It all started with the subprime

At the very beginning of the crisis there was the subprime lending activity. Subprime loans meant that money was given to people with a credit quality which was less than perfect, to say the least. These loans were supported after the mid-1990s by rising prices for properties and houses acting as collateral, by excessive liquidity on the market (low interest rates) and relaxed regulation. Also, the advances in technology helped to simplify the financial procedures by using generally-accepted calculations for credit scores. [1]

The US mortgage market is the largest in the world, and its development was supported by institutions like the Government National Mortgage Association ('Ginnie Mae'), or the Federal National Mortgage Association ('Fannie Mae') and the Federal Home Loan Mortgage Corporation ('Freddie Mac') – agencies which were not guaranteed by the government but benefited from the market's confidence that the state will intervene in case of problems.

From 1970, the year of the first mortgage-backed security (MBS) issued by Ginnie Mae, the MBS market had grown to become the most important sector of the US bond market. This development was sustained by non-agency MBS, meaning instruments

where the collateral was not of a high quality (did not conform to the most demanding requirements). The outstanding volume of mortgage-related securities in the US continually grew between 2002 and 2012,

reaching a peak in 2006, just before the global financial crisis, in what the percentage of non-agency securities is concerned (Figure 1).

Figure 1: U.S. mortgage-related securities outstanding (USD billion)

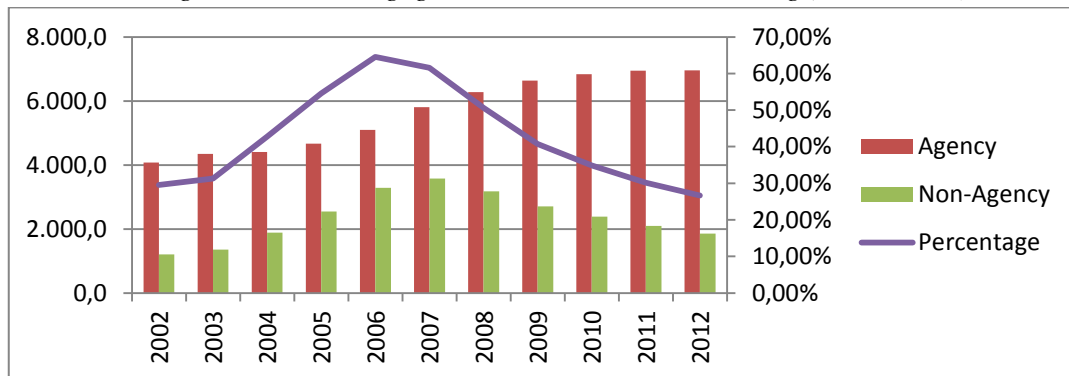

Source: SIFMA (<http://www.sifma.org/research/statistics.aspx>)

The subprime lending activity reached around 20% of the residential mortgage originations just before the crisis and its quality deteriorated (Figure 2). Defaults and delinquencies increased a lot and this started to pose problems to lending institutions that roughened their requirements. This was the point where the spiral began: house prices fell, loans got more difficult to obtain, house stocks increased and house prices fell further. Banks who have invested in instruments having subprime mortgages as underlying (like mortgage-backed securities or collateralized debt obligations) soon found themselves with toxic assets in their

portfolios and facing huge losses. Since nobody knew exactly who were the actors badly hit by this turnaround, banks started to resist lending to each other and this led to liquidity problems in the interbank market [1].

All over the world, central banks had to cut interest rates in order to make sure there is sufficient liquidity on the market. Since the US was the first economy to go into recession, the Federal Reserve was also the first central bank to reduce its rates down to almost zero in 2008. But the effects of the crisis soon appeared.

Figure 2: Quality of prime and subprime mortgages deteriorates

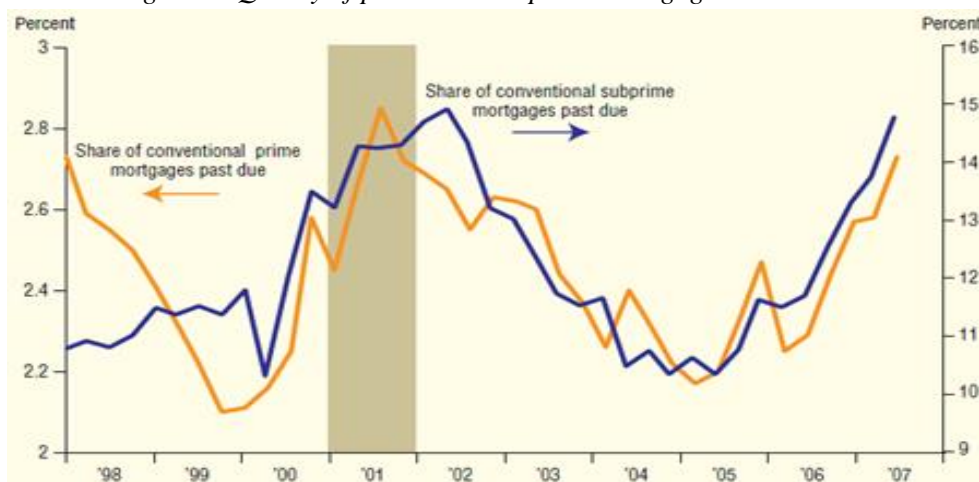

Source : Federal Reserve Bank of Dallas

## **Victims of the crisis in the financial sector**

As expected, the first casualties were from the financial sector, with the biggest of them all being the bankruptcy of Lehman Brothers in September 2008. This was the largest bankruptcy in US history, with USD 639 billion in assets as of its Chapter 11 filing. It was largely due to the percentage of subprime positions in its portfolio. This actor was an icon in investment banking, and many questioned the reasons why the authorities let it to go bankrupt. [1] Maybe the effects of such an event were underestimated, but the authorities soon came to the rescue of other banks, like Bear Stearns, Bank of America, Citigroup, Goldman Sachs and Morgan Stanley.

Bear Stearns received an emergency loan from the Federal Reserve in March 2008 in order to avoid the bankruptcy of this risk-loving bank, but the situation didn't improve and the institution had to be sold to J.P. Morgan Chase. The transaction was closed at USD 10 per share, a price far below its pre-crisis values. Merrill Lynch, another icon of the investment banking industry, was sold to Bank of America for USD 29 per share in September 2008. With almost USD 328 billion in assets, Washington Mutual stopped its activity in the same month of September 2008 and was later sold to J.P. Morgan Chase for around USD 1.9 billion.

American International Group also received a bailout package of USD 85 billion from the Federal Reserve, needed after the largest insurer in the US had to pay a lot of money on its CDS (credit default swap) portfolio.

Two other victims of the crisis in US were the mortgage agencies Fannie Mae and Freddie Mac, whose bailout occurred on September 17, 2008. The Federal Housing Finance Agency (FHFA) put them into conservatorship later on. With around USD 187 billion taxpayer support, this was the largest bailout in US history.

But the casualties were not only in the United States, they were all over the world. The biggest name in UK to suffer from the financial crisis was Royal Bank of Scotland (RBS) who made a bad choice in acquiring ABN AMRO (Netherlands) and reported huge losses in 2008. The UK government now owns the majority of the institution.

Also in UK, the largest home loans provider (HBOS) encountered difficulties after the events in America and ended up being bought by Lloyds TSB; the newly merged entity, Lloyds Banking Group, is owned by the state in a proportion of 43.4%.

Another resounding bailout in Europe was given to UBS, the Swiss bank receiving USD 59.2 billion from the Swiss National Bank after reporting the biggest losses from the credit crisis for a European actor. However, the bank soon regained its composure – with the state selling its stake in less than a year.

In October 2008, Hypo Real Estate became the biggest German company to suffer from the credit crisis. This was the country's second biggest commercial property lender, and after a USD 50 billion bailout by the Bundesbank and other local banks it was soon nationalized.

## **Companies are growing bigger than ever**

All these examples show us that companies are becoming too big to fail, so government intervention becomes mandatory in times of crisis. As the population grows more numerous than ever, companies are growing bigger than ever and reach the power of certain states. The economy depends on them, especially if we talk about the financial sector. 2008 was a year of great changes: we had the oil price spike, the world food shortage, the subprime problem, the global financial crisis, and then the Great Recession. [2] The technological changes are more rapid than ever and influence the way we live and do business. But all the evolution in the capitalism era has mixed results, since many countries struggle to benefit from the progress, while the wealthiest part of the population is getting richer and richer. The anti-charity Oxfam published a report ahead of the World Economic Forum in Davos saying that 1% of the world's population will own more than half of the global wealth by 2016. The international institutions following the Bretton Woods Agreement are actively criticized by many people for failing to assure international development. And the global financial crisis brought all these negative feelings back into our everyday debate. Why should companies be bailed out when normal people are not protected when they run into difficulties? This is an

emotional question which assumes only logical answers. Such companies seem to socialize losses, while during good times the profits go to a limited number of people.

The stability is the first thing on the governments' action plans, but the speculative side of the financial sector is still far away from being controlled.

Problems appear in the real economy as well. Multinational corporations (MNCs) are now more than 60,000 in number and are totaling up to a quarter of world economic output while employing only 1% of the world's labor force. [3] The 10 largest MNCs have annual sales of more than the GNPs of the 100 poorest countries in the world. [4] Are companies becoming more powerful than the states themselves? Are these companies exercising their activity with the same care and concern with regards to local communities as the states do? Should the states let them become so big?

The global crisis could lead us to a new way of doing business or it can continue with the same capitalist model which sums up profits only for the wealthiest of people, until a new crisis strikes in. One way to help money turn away from speculative finance to real economy is by putting tax on financial activity; this is actually a very sensitive area that important governments are tentative to approach. Other measures which have started to be put in place regard the control and regulation activity of the central authorities. Can companies service the good of the society without being controlled and their activity strongly regulated? The most recent scandal of Volkswagen cheating pollution emission tests shows us that one more industry apart from the financial one should be put under intense scrutiny. The auto industry was one of the hardest hit by the financial crisis. General Motors, one of the most important players in the US industry, declared bankruptcy in June 2009 and received a bailout of USD 49 billion. Chrysler was another player who had to be bailed out by the government. This same industry is now under the critical eye of the public opinion.

We all talk about total quality and corporate social responsibility. Are these actually put in place by MNCs and to what extent? It is only through continuous development of skills and capabilities,

creativity, and innovation that firms can optimize financial, social, and environmental performance. [2] In contrast to MNCs, we have other phenomena, like social entrepreneurship or impact investing initiatives.

MNCs must learn to get to know local communities in which they do their business, adapt and create new business models which can serve both the profit targets and the social needs of the population. States and companies are faced with the difficult task of creating new jobs through new technologies, increasing the purchasing power of the population, and solve environmental problems.

### **Socially innovating examples**

The first and most important impact of the Great Recession was on the financial industry's image. The ethics of the banks' activity were questioned by many. But there are banks that managed the crisis better than others. [5]

J.P. Morgan had a net income of USD 5.6 billion in 2008 and USD 11.7 billion in 2009, continuing to serve their 90 million customers and operating with care and consideration toward the communities in which they exercise their activity. The bank didn't have subprime exposure on its portfolios and that is because this type of instruments was not conforming to the risk/return policy of the corporation.

Other banks that didn't have much subprime exposure were the Canadian banks Toronto Dominion, RBC, and CIBC. In a market which had subprime mortgage at only 5% of the total (compared to United States' 20%), RBC had profits of USD 4.45 billion in 2008 and USD 3.39 billion in 2009, CIBC registered a profit of USD 1.2 billion in 2009, while Toronto Dominion had profits of USD 3.7 billion in 2008 and USD 2.7 billion in 2009. [8]

In Western Europe and not only, Banco Santander is one of the banks that have escaped unhurt from the financial crisis. It had become in 2008 the third-largest bank in the world by profit (USD 54.3 billion) and the first by market capitalization in the Eurozone (EUR 88.9 billion) according to the company's reports.

BNP Paribas, the third largest capitalization in Europe with EUR 63.9 billion (2008), is a French bank that knows how to mitigate risks. It has made profits in both 2008 (EUR 3.45 billion) and 2009 (EUR 6.47 billion). The key to its success was again the reduced exposure to derivatives having subprime mortgages as underlying (reduced exposure brought by its conservatism and principles to not enter into a business that they do not fully understand). This strong position allowed the bank to acquire Fortis and open up new markets in Belgium and Luxembourg during the financial crisis. [5]

All these banks have very solid business models and long-term strategies well followed by their employees. They may not have gained as much as other similar counterparts did before the financial crisis, but surely made up for the lost time when the credit crunch struck. The speculative activity in investment banking may change after the global crisis and may return to the basic values of respect and care for the customer and the business. Those who resisted the wave were in the end on the winning side.

Regulation is often looked at by financial institutions as an obstacle in the way of profits, instead of regarding it as the basis for sound business models. Business people's behavior (which is modeled in school) tends to concentrate on maximizing the profit and on short-term results. There is very little learning on why regulation is needed and is healthy for an economic system. Also, too little debate and too few discussions about this...

Banks should look to be at the benefit of the society as a whole and not to just make money out of money. Some of the missions of the banks prove, at least at a declarative level, that they have understood this. Banca Prossima, part of the Italian Intesa Sanpaolo group, has the following mission: "The company's purpose shall be the creation of social value." American bank BB&T has the mission to make the world a better place by helping our clients achieve economic success and security creating a place where our employees can learn, grow and be fulfilled in their work making the communities in which we work better places to be." J.P. Morgan has stated that its plan is to "support and serve our 90 million customers and the

communities in which we operate." While for GLS, the first German bank to found its activity on an ethical philosophy: "The aim of the bank is to contribute to the sustainable development of society. GLS Bank sees money as a means to make things happen in society." [5]

## Conclusions

All the examples provided here, of banks making profits during crisis or adopting a different style of doing business, show us that it is possible to resist the opportunistic behavior and to focus on creating value in the society rather than just making money. Such socially innovative companies distribute their income to a larger population, and with them the human cost of the crisis has been a bit lower. Also, by not being exposed to the subprime lending activity, these banks created trust among their partners, be it regular people (who weren't evacuated from their homes) or institutional counterparts (who knew they could do business with the banks without much credit risk).

You cannot be successful, as a MNC, without the success of the community in which you operate. And instead of innovating by maximizing profits, the banks could innovate by regaining the trust of their customers and investing in the development of the communities they represent. Using corporate social responsibility to bring an impact to the society could be the next winning strategy of MNCs all over the world, especially if they want to continue to expand and reach new markets (with a lower degree of development).

Being ethical in everything they do (without exception) and associating sound business principles with the everyday activity can become the centre of the organizations' sustainable development. And in the end, being socially innovative will be the most secure safety net for the next crisis, which all professionals hope to be less extended and with less human costs.

## References

- [1] <http://www.intuition.com/content-libraries/>, The Financial Crisis eLearning course from the Intuition Know-How eLearning library [Accessed on October 30, 2015]

- [2] Hart, L. S., *Capitalism at the Crossroads: Next Generation Business Strategies for a Post-Crisis World*, Pearson, New Jersey, 2010
- [3] Rajan, R., Zingales, L., *Saving Capitalism from the Capitalists: Unleashing the Power of Financial Markets to Create Wealth and Spread Opportunity*, Crown Publishing Group, 2003
- [4] Bhagwati, J., *In Defense of Globalization*, Oxford University Press, New York, 2004
- [5] Spitzeck, H., Pirson M., Dierksmeier, C., *Banking with Integrity: The Winners of the Financial Crisis?*, Palgrave Macmillan, 2012
- [6] SIFMA, Available at <http://www.sifma.org/research/statistics.aspx> [Accessed on October 30, 2015]
- [7] Federal Reserve Bank of Dallas, Available at <https://www.dallasfed.org/assets/documents/research/ecllett/2007/el0711.pdf> [Accessed on October 30, 2015]
- [8] Company financial results mentioned in this paper are taken from: <https://ycharts.com> [Accessed on October 30, 2015]

## Effects of the Global Financial Crisis on the Resources of Health System in Romania

Simona Ghita

*Academy of Economic Studies in Bucharest - Department of Statistics and Econometrics*  
[simona.ghita@csie.ase.ro](mailto:simona.ghita@csie.ase.ro)

Emilia Titan

*Academy of Economic Studies in Bucharest - Department of Statistics and Econometrics*  
[emilia.titan@csie.ase.ro](mailto:emilia.titan@csie.ase.ro)

Cristina Boboc

*Academy of Economic Studies in Bucharest - Department of Statistics and Econometrics*  
[cristina.boboc@csie.ase.ro](mailto:cristina.boboc@csie.ase.ro)

### Abstract

*In the last 20 years, the health system in Romania faces a lot of deficiencies, which have worsened during the global financial crisis. Some of the statistical indicators characterizing the human, material and financial resources of health system experienced a positive evolution (number of private hospitals, total medical staff, health expenditures per capita), although – compared to other European countries – Romania has still a lot of problems to solve. The analysis aimed at characterizing the correlation between the evolutions of the above-mentioned indicators of health system resources, testing the existence of a significant difference between the pre-crisis and the post-crisis indicators level.*

**Key words:** health system, resources, correlation analysis, non-parametric test

**J.E.L. classification:** C12, C14, I10, I18.

### 1. Introduction. Specifics of the Romanian health system in specialty studies.

Specialists show that Romanian health system is far from being an efficient one. On contrary, it has a lot of gaps and deficiencies, deficiencies that may deepen during the global financial crisis, as it comes with a resource-diminishing process. It is not necessarily a specific problem of Romania, but one facing all former socialist countries, which are struggling with the difficulties of the transition process from a centralized

socialist economy to a free market, competitive economy. Romania has, however, the advantage of a highly qualified workforce in the medical-health, but also the disadvantage of poor financing. Cicea C., Busu C. and Armeanu E. (2011) reveal that there are five main financing-methods for medical systems: state budget financing, social health insurance financing, private health insurance financing; direct payments financing, and community financing. But none of them can miraculously cure our health care system wounds, deepen for so many years. The key to effective financing – according to the authors - is the resources allocation - according to six key elements: the ability to generate the required revenue; equity; risk pooling; efficiency; medical services quality and sustainability [1].

The health system in Romania is marked by a series of disparities manifested in access to healthcare: ethnical or racial disparities, economical, regional and quality disparities. Currently, the health system in Romania is mainly a social insurance – type, and it aims at providing a balanced and non-discriminatory access to basic services package for policyholders.

Feraru P.D. (2013) identifies a few solutions for solving one of the biggest problems of Romanian medical-care system: migration of the physicians. This can be diminished by adopting new regulations referring to work-time conditions and family situation, by adopting relocation strategies (especially in rural areas), by adopting new strategies regarding the praxis activity [2].

In a survey performed on two samples (a



sample of physicians and a sample of patients), in 2012, Suciuc M.C., Stan C.A., Piciorus L. and Imbrisca C.I. identify similar opinions for both samples regarding the causes of the crisis facing the Romanian medical system: insufficient amounts allocated annually from the state budget, inefficient management, lack of high-performance medical equipment. Lack of jobs, working conditions and inadequate wages are the main causes of migration of physicians. Only 21% of the respondents have a good or very good opinion about the public health system in Romania, compared to 79% - who share such an opinion about private health system [3].

Pirvu D. and Didea I. argue the need for decentralization of health services in Romania, in order to improve the quality of medical services offered to the population [4].

## 2. Particularities of health system in Romania. Characterization of health system resources.

The characterization of health system resources in Romania goes from three components: human resources, material resources and financial resources.

**Human resources:** The number of physicians per 1000 inhabitants in Romania reached in 2008 the lowest level in European Union (of only 2.2 physicians per 1000 inhabitants), while Greece had the highest number of physicians per 1000 inhabitants (6 physicians per 1000 inhabitants), followed by Austria and Italy (with over 4 physicians per 1000 inhabitants). After four years (in 2012) the situation remained practically unchanged, the ranking of European countries was led by Greece (with 6.2 physicians per 1000 inhabitants), followed by Austria, while Romania was ending the ranking (with only 2.5 physicians per 1000 inhabitants) [5]. Analyzing the evolution of total medical-sanitary personnel by staff categories (medical staff with tertiary education level, auxiliary medical staff and ancillary medical staff) (Figure 1) we may observe that the first category registered the highest increase during 2000-2014 period, according to the data provided by the National Institute of Statistics, an increase by 41.8% in 2014 compared to 2000; the other two categories

of medical personnel experienced increases between 5% and 8%. Also, the number of auxiliary and ancillary medical staff increased between 2000 and 2008 (before the global financial crisis), experiencing after that a sensible decrease. On contrary, the upward trend of the number of health professionals with higher education was not interrupted by any crisis, continuing until 2014.

Figure 1. The evolution of medical-sanitary staff in Romania, 2000-2014 (persons)

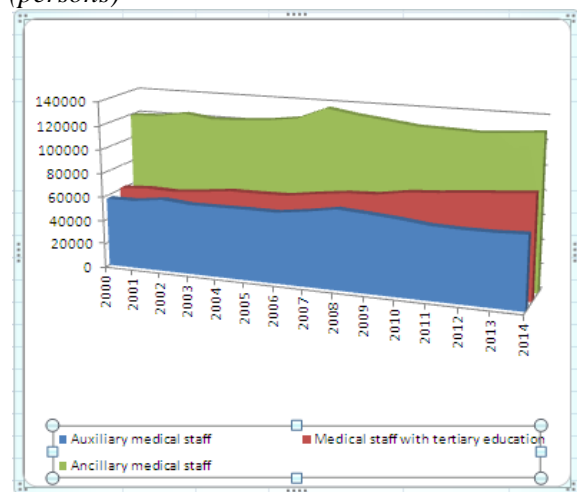

Source: authors' processing, based on National Institute of Statistics, Tempo-online [6]

**Material resources:** The number of hospitals in Romania increased by 19% in 2014 compared to 2000, based on an exponential growth of the share of private hospitals (from 0.67% in 2000 to 30.55% in 2014) (Figure 2). The number of hospitals in public property has decreased by 17% in 2014 compared to 2000. The number of beds in hospitals and health centers experienced a decrease by 21.65% in the analyzed period.

Figure 2. The evolution of number of hospitals in Romania, by property, 2000-2014

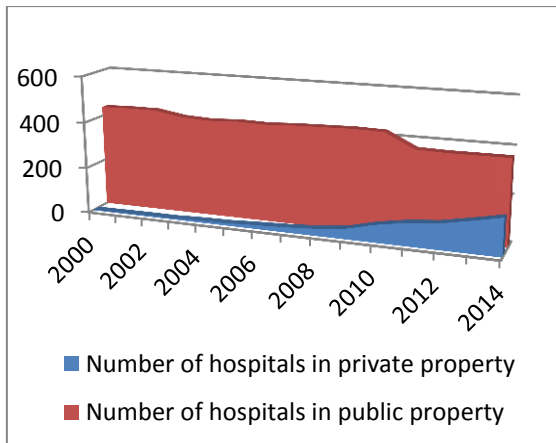

Source: authors' processing, based on National Institute of Statistics, Tempo-online [6].

**Financial resources:** The level and the evolution of health expenditures in Romania were influenced by many economic and social variables, studies indicating a strong correlation between them and GDP level. In 2012, the top countries in an European ranking by health expenditure per capita are Norway and Switzerland (with 4500 Euro per inhabitant), followed by the Netherlands (3829 Euro per person), Austria (3676 Euro per person) and Germany (3613 Euro per person), with values above the European average. At the opposite end of the scale were located: Romania (with 753 Euro / person) and Bulgaria (900 Euro / person). Romania is among the countries where the health sector financing comes in a very high proportion from public sector (80%). The 2008 crisis had among its consequences a dramatic reduction in health expenditure in some countries. In Romania the average annual growth rate of health expenditure per capita fell from 9.1% in the pre-crisis period (2000-2009) to 0.4% in the post-crisis period (2009-2012) [7]. Looking at the proportion of health expenditure in GDP, in 2012 Romania was ranked last among European countries (only 5.6%), preceded by the Baltic countries: Latvia (5.7%), Estonia (5.9%) and Lithuania (6.7%) [7] (Figure 3).

Figure 3. The evolution of health care expenditures in Romania (% of GDP)

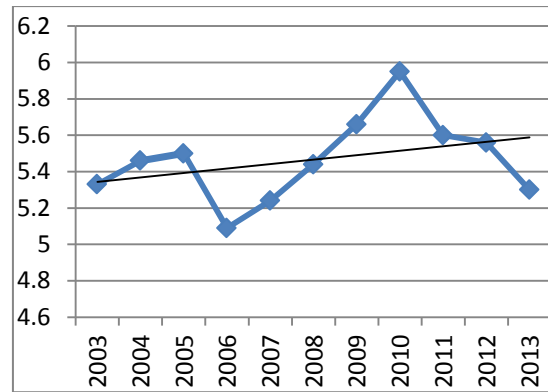

Source: EUROSTAT, Health database [8], World Bank (World Development Indicators: Health systems) [9]

The Netherlands ranked first (11.8%), followed by France (11.6%), Germany (11.3%) and Austria (11.1%). In the 2002-2013 period, in Romania, the share of health expenditure in GDP has fluctuated, reaching a minimum level in 2006 (5.09%) and a maximum level in 2010 (5.95%). It is, however, worth mentioning that after 2010 the indicator registered a downward trend, reaching 5.3% in 2013.

### 3. Data & Methodology. Main results of the analysis.

In order to quantify the three categories of health system resources, there were used the following statistical indicators:

**Human resources:** *Medical staff* – including medical staff with tertiary education (general physicians, specialists, dentists, pharmacists), auxiliary medical staff and ancillary medical staff.

**Material resources:** *Hospital beds* related to certain medical specialties (including in the health centers), at the end of the year; *Number of hospitals* (in public and private property).

**Financial resources:** *Health expenditure* (as a percent of GDP) and *per capita health expenditures* (Euro/capita).

The values of human resources indicators and material resources indicators were provided by the National Institute of Statistics, Romania (Tempo-online database), while the values of financial indicators were provided by the EUROSTAT (Health database).

The analysis aimed at characterizing the correlation between the evolutions of the

above-mentioned indicators of health system resources, between 2003 and 2012. Correlation analysis was performed based on graphical method (scatter-plot) and correlation matrix, obtained based on Spearman rank correlation coefficient, with significance testing for all pairs of variables analyzed. The processing was performed using IBM SPSS Statistics software package 20. In the analyzed period, there were some negative strong correlations between the following pairs of variables: number of hospital beds and health expenditures per capita (-0.782), number of hospital beds and number of hospitals (-0.709), and some positive strong correlations between the following pairs of variables: number of hospitals and health expenditures per capita (+0.782), medical staff and health expenditures per capita (+0.770). All the above-mentioned Spearman coefficients are statistically significant, for 5% significance level (Table 1).

Table 1. Correlation Matrix – Resource Indicators in Health Sector, Romania, 2003-2012.

Spearman's rho		Beds	No. hospitals	Medical staff	Health exp. (% of GDP)	Health exp. per cap
Beds	Correlation Coefficient	1,000	-,709*	-,552	-,467	-,782**
	Sig. (2-tailed)	.	,022	,098	,174	,008
	N	10	10	10	10	10
No. hospitals	Correlation Coefficient	-,709*	1,000	,685*	,697*	,782**
	Sig. (2-tailed)	,022	.	,029	,025	,008
	N	10	10	10	10	10
Medical staff	Correlation Coefficient	-,552	,685*	1,000	,176	,770**
	Sig. (2-tailed)	,098	,029	.	,627	,009
	N	10	10	10	10	10
Health exp. (% of GDP)	Correlation Coefficient	-,467	,697*	,176	1,000	,455
	Sig. (2-tailed)	,174	,025	,627	.	,187
	N	10	10	10	10	10
Health exp. per cap.	Correlation Coefficient	-,782**	,782**	,770**	,455	1,000
	Sig. (2-tailed)	,008	,008	,009	,187	.
	N	10	10	10	10	10

\*. Correlation is significant at the 0.05 level (2-tailed).

\*\* . Correlation is significant at the 0.01 level (2-tailed).

Source: Authors' processing in SPSS 20.0, based on EUROSTAT data – Health Database [8] and National Institute of Statistics – Tempo-online database [6].

Figure 4. Scatter plot – Number of beds in hospitals and health-expenditures (EUR/inhabitant), Romania, 2003-2012

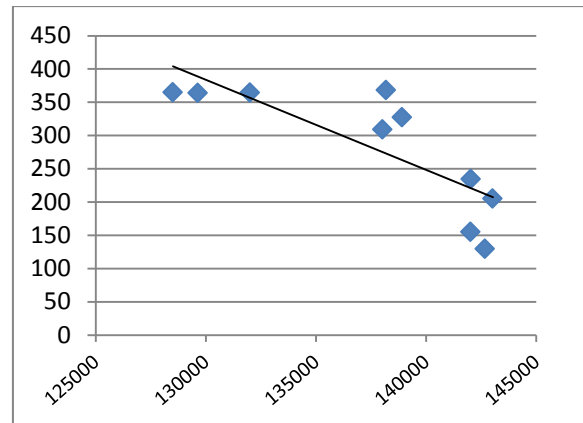

Source: Authors' processing in SPSS 20.0, based on EUROSTAT data – Health Database [8] and National Institute of Statistics – Tempo-online database [6].

Figure 5. Scatter plot – Medical-sanitary staff (persons) and health-expenditures (EUR/inhabitant), Romania, 2003-2012

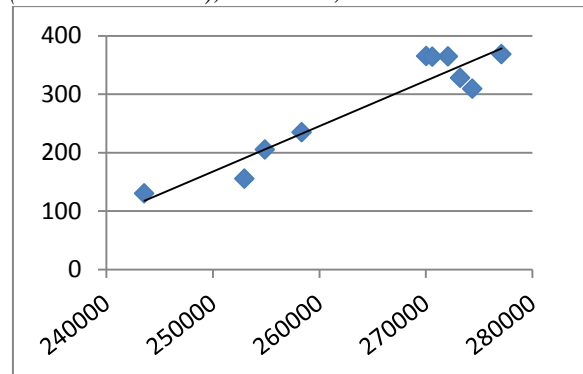

Source: Authors' processing in SPSS 20.0, based on EUROSTAT data – Health Database [8] and National Institute of Statistics – Tempo-online database [6].

Further, the analysis focused on testing the existing of significant differences between average health spending per capita in the period prior to the financial crisis and the one after the crisis. For this it was used the Mann-Whitney test for two independent samples. Test results are shown in Tables 2 and 3.

Tables 2 and 3. Mann-Whitney Test for Health Expenditure (EUR/inhabitant)

Ranks				
	Period	N	Mean Rank	Sum of Ranks
EUR/inhabitant	Before crisis	5	3,00	15,00
	After crisis	5	8,00	40,00
	Total	10		

**Test Statistics<sup>a</sup>**

	EUR/inhabitant
Mann-Whitney U	,000
Wilcoxon W	15,000
Z	-2,611
Asymp. Sig. (2-tailed)	,009
Exact Sig. [2*(1-tailed Sig.)]	,008 <sup>b</sup>

a. Grouping Variable: Period

b. Not corrected for ties.

Source: performed by the authors, based on IBM SPSS Statistics 20.

The analysis revealed that in post-crisis period the average health-care expenditure per capita were significantly higher compared to the pre-crisis period, which can be explained by the fact that - although Romania holds the last place in the European countries ranking regarding health spending per capita – the indicator level followed an upward trend in both periods: before and after the crisis. This conclusion has a high confidence level (over 99%). Unfortunately, the conclusion doesn't stand if we consider the relative level of health expenditures – as a percent of GDP, the test showing that there is no significant difference between the two periods of time, from this point of view.

#### 4. Conclusions

Romanian health system deals with many problems, most of them coming from the lack of financial resources and from the resource-allocation problems. Specialist identified six main key elements for resources allocation management : the ability to generate the required revenue; equity; risk pooling; efficiency; medical services quality and sustainability. But we can rely on one advantage: a highly qualified workforce in the medical-health, which, unfortunately, in recent years, contributes to a widened brain-drain phenomenon.

The paper analyzes the level and the evolution of health system resources: human, material and financial resources in Romania, before and after the economical-financial crisis. Romania needs a higher number of physicians, as it has ranked last of the European countries, in 2012 (with only 2.5

physicians per 1000 inhabitants). The number of hospitals in Romania increased by 19% in 2014 compared to 2000, based on an exponential growth of the share of private hospitals; but the number of beds in hospitals decreased by 21.65% in 2014 compared to 2000. Romania ranked last among European countries by health expenditure per capita, with 753 Euro/person; only 5.6% of the GDP represented the health expenditures in 2012.

The analysis revealed some negative strong correlations between the number of hospital beds and health expenditures per capita (Spearman's rank coefficient: -0.782), on one hand, and the number of hospital beds and number of hospitals (Spearman's rank coefficient: -0.709) on the other hand; it also revealed some positive strong correlations between: the number of hospitals and health expenditures per capita (Spearman's rank coefficient: +0.782) on one hand, and the medical staff and health expenditures per capita (Spearman's rank coefficient: +0.770) on the other hand.

The application of non-parametric significance tests for comparing two independent samples revealed that in post-crisis period the average health-care expenditure per capita were significantly higher compared to the pre-crisis period, which can be explained by the fact that - although Romania holds the last place in the European countries ranking, regarding health spending per capita – the indicator level followed an upward trend in both periods: before and after the crisis (over 99% confidence level).

#### 5. References

- [1] Cicea, C., Busu, C., Armeanu, E., „The SWOT analysis of the Romanian health care system and the key elements for resources allocation management research and practice”, *Management Research and Practice*, Vol. 3 Issue 3, 2011, pp. 32-41.
- [2] Feraru, P.D., „Romania and the Crisis in the Health System. Migration of doctors”, *Global Journal of Medical Research Interdisciplinary*, Volume 13, Issue 5, Year 2013, Publisher: Global Journals Inc. (USA).
- [3] Suci, M.C., Stan, C.A., Piciurus, L., Imbrisca, C.I.,” The Post-Crisis Healthcare System: Effects of the Economic Crisis in Romania”, *Theoretical and Applied Economics*, Volume XIX (2012), No. 5(570),

- pp. 157-168.
- [4] Pirvu, D., Didea, I., „Decentralization of Health Services in Romania”, *Scientific Bulletin – Economic Sciences*, Volume 12/ Issue 2, Pitesti, 2013.
  - [5] EUROSTAT: Statistics Explained: Healthcare expenditure statistics – May 2015, [http://ec.europa.eu/eurostat/statistics-explained/index.php/Healthcare\\_expenditure\\_statistics](http://ec.europa.eu/eurostat/statistics-explained/index.php/Healthcare_expenditure_statistics).
  - [6] National Institute of Statistics, Tempo-online, <http://statistici.insse.ro/shop/>.
  - [7] OECD (2014), Health at a Glance: Europe 2014, OECD Publishing. [http://dx.doi.org/10.1787/health\\_glance\\_eur-2014-en](http://dx.doi.org/10.1787/health_glance_eur-2014-en)).
  - [8] EUROSTAT, Health database, <http://ec.europa.eu/eurostat/web/health/health-care/data/database>.
  - [9] World Bank (World Development Indicators: Health systems) <http://wdi.worldbank.org/table/2.15>

# Negotiating T-TIP – Key Issues and Potential Implications for the Third Countries

Ioana Gutu

Alexandru Ioan Cuza University of Iasi

[gutu.ioana@yahoo.com](mailto:gutu.ioana@yahoo.com)

## Abstract

*T-TIP is a currently negotiated bilateral agreement between the European Union and the United States of America. In the eventuality of concluding the agreement, there are expected considerable gains for both of the involved economies, but also for the current trade partners of both negotiators i.e. third countries. Literature and also studies performed in the name of the European Commission try to quantify these effects on a global scale, by taking into consideration the consequences of the largest bilateral agreement ever concluded, on the multilateral system. Unanimously, authors agree that among third countries, the most unaffected will be the producers of raw materials and industrial supplies, since they are very hard or impossible to replace with similar feedstocks. In a globalized economy, by choosing regionalism in the detriment of multilateralism through not accepting the accession of other parties into the T-TIP negotiations, both EU and US risk to be marginalized from the world trade system by the multilateral agreements that the main emerging economies will be forced to accede to.*

**Key words:** T-TIP, third countries, multilateralization

**J.E.L. classification:** F15

## 1. Introduction

Starting with the year of 2013, the European Union (EU) and the United States of America (USA) are negotiating on what is expected to become the largest free trade and investment agreement ever agreed, namely the Transatlantic Trade and Investment Partnership (abbreviated as T-TIP). Under this light, there would be created the largest

free market on the world, fact that would be considerably experienced by the world trade system, including the third countries. In the literature there are numerous debates that focus on the potential positive or negative effects, assumptions that are backed up with arguments based on findings that resulted from using different algorithms and measurements. The positivists foresee a significant gain for all the main and collateral involved economies, while the opponents predict grave disruptions within the world trade system. Due to the fact that T-TIP is a bilateral agreement, the attention is concentrating on the not involved third economies, which represent a concern for the economists.

## 2. Trade and social well-being of the third countries

The predictions in regard with the benefits resulting from the enforcement of T-TIP release additional growth of Euro 119 billion/year for the EU and Euro 95 billion/year for the US; according to European Commission (EC), the involvement of third countries within this process would bring them an additional growth of Euro 100 billion in GDP. As a remark, not only the countries that actively negotiated the provisions of T-TIP would benefit from it, but also the existing trade partners of both EU and US. Felbermayr et al. in a study for Bertelsmann Stiftung [1] describe the effect of agreeing over T-TIP for the third countries by considering two main cases: the direct effect over the trade barriers, by maintaining the existing tariff and non-tariff barriers with the countries that are not part of the agreement, and the second scenario, supposing that rules, standards and other procedures will uniformise and create a deeper liberalization.

In the tariff scenario, it result as the main beneficiaries from agreeing over the transatlantic joint economies, the two main actors – EU and US; in regard with the third countries, disproportionate gains will have countries that export raw materials for which there are no and/or few substitutes. As a surprise, countries like Kazakhstan or Brazil would gain more than even the two main targeted economies. According to this study, the loses of the process are the developing countries from N and W Africa, whose exports will compete with the ones of the USA which will be treated as preferable by the EU; the logic behind this process states that the relative existing barriers in relation with the market entrance of these developing countries will become higher, giving no alternative to the most weak economies.

On the second possible course of events, the one that supposes a deep liberalization, it is foreseen an even more obscure scenario, determining the trade diversion to become more intense; in the case of non-tariff barriers, countries that already trade with EU and/or USA are indirectly taken into account within the T-TIP negotiations, so that it is more likely for these partners to adopt the same standards and regulations. The traditional trading partners of EU and US are the most affected parties by the agreement, fact that will determine some parallel actions: imitate the already existing barriers between EU and USA or create or improve the bilateral agreements that they have with the two main negotiation parties.

Another study that dealt with the effects of T-TIP over the developing countries was made by CARIS for the UK's Department for International Development (DFID) [2], being one of the first studies that specifically take into consideration the impact of T-TIP over the third countries. The presented scenario accounts for 43 developing countries that were selected by DFID or that are a part of the World Bank's list of low-income countries (LIC), taking into consideration tariff removal and an increasing compatibility of the non-tariff measures between EU and USA. By referring to a comprehensive tariff liberalization, Rollo et al. [3] use three approaches of elaborating a potential impact of T-TIP. The first two methods imply quantitative analysis, followed by a third qualitative method that

links the most likely standards and measures that could have an impact on precise labor outcomes and producing countries. The results of the quantitative methods showed that neither EU nor USA compete in a significant way with the LICs, on the EU-US market or outside it. Also, another result is that, despite the fact that tariffs with the products that are imported from the developing countries are low, there are tariff peaks in regard with certain sphere of products exported from the Low Income Countries (LIC) in areas where replaceable trading goods are hard or impossible to obtain from other sources. The key aspect of such an analysis also supported by Ulgen (2014) [4a] and Berger and Brandi (2015) [4b] says that if a developing country's products meet the standards of one of the partners (EU or US), they should be treated as meeting the rules of the other. This is one of the desirable effects of T-TIP, the agreement's text having one entire chapter dedicated to the rules and regulations uniformisation.

A third and more recent study that takes into account the possible impact of agreeing over T-TIP on the third countries and emerging economies was implemented by IFO Institute for Economic Research (Munich) and the Institute for Applied Economic Research at the University of Tübingen [5]. This study approaches a theoretical description of the T-TIP impact over the third countries, based on a vast literature review and relevant interviews with representatives of relevant interested parties.

The main recommendations include non-discriminatory treatment in the area of future regulatory procedures, regulatory harmonization and non-tariff barriers. As previously described in regard with protecting and enhancing the emerging economies in the new transatlantic game, the literature offers specific actions and measures to be taken, the positive and negative opinions meeting somewhere on the middle of the curve, and none of them prevails in the process.

### **3. The advantages and disadvantages of the effects of TTIP on the multilateral system**

When about the multilateral system and its change as a consequence of implementing T-TIP, literature reveals numerous contradictory views. According to Aichele et al. [6] the bilateral agreements have a deeper effect over the sectors of manufacturing and services, but the potential effect of T-TIP on the non-members is more prominent; the biggest losers according to this study are the ASEAN region and China, rallying in this way with the majority of the positions of the specialists.

In the opinion of Draper et al. [7] when about the effects of a mega regional agreement, the discussion takes into consideration the discriminatory effects over two categories of countries: WTO-plus and WTO-extra. Given these conditions, the multilateralization effects derive from the intrinsic chapters provisions and their effect for the third countries; for this reason, the recommendations maintain the idea of globally encouraging EU and US to multilateralize the negotiations, so to reduce the negative impact over the non-involved economies.

Uri Dadush [8] talks about the potential actions that the excluded countries could have in order to minimize the negative effects of T-TIP over their economies. For this concern, the author offers the solution of undertaking the agreement within the WTO framework, as a plurilateral approach; as a shadow of the idea of adopting the agreement's provisions, the options include trade reforms on a country level as well as bilateral agreements on trade and investments with one of the two partners – EU and US. A dangerous approach on this subject is given by Berger et al. [9] which states that the interested states that are not involved in negotiations over T-TIP could join together and form opposing trade blocks; in this case, the solution they offer is to consider the large economic potential of these economies and to focus within negotiations on cooperating rather than excluding the third economies.

Agreements like T-TIP throw light over the global inequality and try to find solutions for shaping the globalization process in a fair and equitable way for all the actors involved. Berger et al. [10] insist on the indirect consequences of T-TIP on the "geometry of the world trade system", because it covers areas that were not yet negotiated under the

WTO framework, establishing by these means a benchmark in regard with general rules of global trade. They raise a question mark when about the fairness of the world trade and the validity of the provisions of mega regional agreements as T-TIP over the excluded economies.

Joseph Francois [11] opines that an increased flow of goods and services on the trans-atlantic market would benefit for most of the countries from the rest of the world, due to lowering tariffs and trade creation and diversion that result in spill-over effects. According to the performed study, there will be registered a significant increase in GDP value for both of the selected spheres of interest: EU and US on one side and the rest of the trading partners, on the other side.

A notably sphere of interest is represented by the concluding of TPP agreement, between US and 11 other states. As Freitag et al. [12] conclude, in a geostrategic area where there is a rise of great powers like China and India on the horizon, a multilateral agreement under the shape of a trans-pacific cooperation may have more significant long term effects than the bilateral cooperation between Europe and North America. In the eventuality of establishing an Asia-Pacific Economic Cooperation (APEC) agreement, incorporating emerging Asian and Pacific countries, together with Japan, China and US, will be interpreted as an building block of multilateralism, from where EU will be for sure excluded. The new geopolitical order that has an increased chance to be established, will have an incomensurable effect over the multilateral economic and trade cooperation among the world, the effects over the excluded economies, commencing with the EU being presumed as devastating, since such a multilateral arrangement would be self-sufficient and would practically destroy any cooperation relation based on imports and exports of raw materials and services between the third countries and the members of the multilateral block.

#### **4. The vulnerability of third countries – the EU and US current trading partners?**

When talking about T-TIP and its effects on the third parties, there are three main categories that can be referred to: (i) the



existing EU and US trading partners that are not taking part within the negotiations; (ii) the sub-regional trade blocks that group economies mainly according to their geostrategic position in the world and (iii) states that have a great economic potential, that do not currently have any trade relation with one of the two main economies, but that have the intention of entering on the transatlantic market.

As Freytag et al. [13] the ambiguity in regard with trade with the third countries is not the tariffs, but how the non-tariff barriers will be treated; the same author emphasises, new T-TIP regulations "might not (but could) be formulated to explicitly and deliberately discriminate". The main problem with this idea is that one of the main goals of T-TIP is to set a path for the global standards, that will mainly backup the provisions in regard with trade from the newly negotiated TPP; the main problem here, will still be the reaction and possible implications for the third countries economies.

T-TIP will mostly affect the economies that mainly depend on export to the two involved economies, this making them vulnerable to trade diversion. In order to prove these sayings, in the Figure , on the Y axis will be presented countries that already export to the EU and US markets, and on the X axis are shown the 10 most frequently exported products that are affected by tariffs higher than 4% in EU and US.

Figure 1. Trade diversion effects over the main EU and US exporters, developing countries

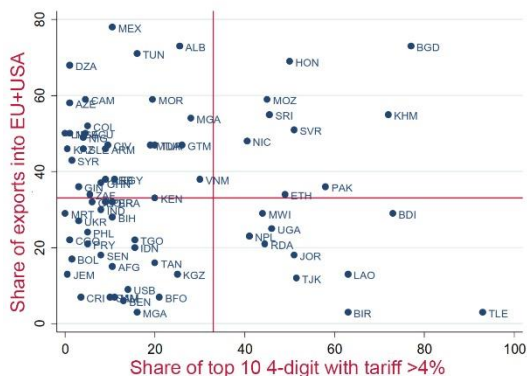

Source: M. Sait Akman, Simon J. Evenett, Patrick Low, Catalyst? TTIP's impact on the rest, Economic Policy Research Foundation of Turkey, CEPR Press, 2015

Countries located in the upper right corner are the most exposed to trade diversion, meaning that if now they comply with the greater EU and US tariffs on import (in accordance with the nature of the good imported), in case of agreeing over T-TIP, these tariffs will disappear, determining the eastern Europe producers to become more competitive and gain market share, fact that will be a negative effect for countries like Bangladesh (BGD) or Cambodia (KHM).

Countries from the top left are less affected by the trade diversion that T-TIP may cause, due to the fact that these countries are the main exporters to EU and US of raw materials or industrial supplies that are hard to be replaced or found in relation with another country.

T-TIP was under its 11th round of negotiations in the mid October 2015. It is unlikely that EU and US would accept new members unconditionally. Under this light, for the interested parties, one secure escape would be to conclude bilateral agreements with one of the two economies and to accept the regulations provided by the bilateral treaty. It seems probable that T-TIP members will accept other economies to join, after the agreement has been concluded, but not without complying with a vigorous set of conditions that the others must accept, before joining.

Multilateralization will be strongly affected by T-TIP measurements, rules and regulations in relation with trade. After the effort from the Doha Round, it was certified that mega-trade deals are hard to be achieved and that in certain cases the WTO framework may be stuck so that multilateralization may be brought through the back-door, as Akman et al. [11] show. The big risk of this case is the ability of T-TIP to be translated into WTO norms that would reflect the practice of the other members.

It is crucial for the third countries to understand that T-TIP is not an agreement designed to action against their economies. Both EU and US should make efforts on developing accession mechanisms by using soft power and by creating a secure and desirable transatlantic market for all the other economies. If this perspective will not be embraced by the two main T-TIP negotiators, the risk will be that the trans-atlantic

economy to be captured into a glass bubble, while all the other economies will continue to develop through other healthy and easy to access trade alliances, where multilateralism is the central piece of resistance.

## 5. Final remarks

WTO will soon reach its 20th anniversary; US as its founder, together with its predecessor – the General Agreement of Tariffs and Trade (GATT) started negotiations outside this framework. With joining the negotiations of TPP and initiating alongside with the EU the ones on T-TIP, it is noticeable the US trend of being a part of a regional approach, manifesting a preference for mega-regionalism, instead of multilateralism.

Recently, the rise of the new emerging economies created an unprecedented effect in the world trade area, by manifesting a significant economic and political influence over the old order. Meanwhile, the EU and US economies have been weakened by the Global Financial Crisis from 2008, fact that was as a takeaway gift for the small countries that took advantage of the economic and financial situation and entered to the main markets of the world.

As a response to the threatening advance of the third countries, EU and US launched in 2013 the negotiations over T-TIP, by not allowing any other economy to join the talks and setting as the main objective, reducing transatlantic trade barriers to zero. In the case of this scenario becoming true, the current trading partners of both EU and US will suffer a great disadvantage, even though the European Commission released data according to which these economies will benefit of an increase of 100 billion in GDP. The economies that will not be affected by the trade diversion will be the ones that export raw materials and industrial goods, the studies showing an increase in the GDP of these states, due to a raising demand from the joint transatlantic EU-US market.

The effect that T-TIP will have over the multilateralization is still a question mark for the economists; while the negotiators do not accept on the round table extraneous parts, the only viable supposition is focusing on the provisions of the final text of the agreement, with regard to accession from the other

interested states. If third parties will not benefit from those provisions, the responses will not be favourable for neither of the negotiation sides; but if T-TIP will result in favourable provisions in regard with third countries economies, this agreement might transform in the foundation of a further transformation of the world trade system's economic prospects.

## 6. References

- [1] Flebermayr G., Heid B., Lehwald S., "Transatlantic Trade and Investment Partnership (TTIP)", Bertelsman Stiftung, 2013, pp. 26-28.
- [2] Rollo J., Holmes P., Henson S., Mendez M., Ollerenshaw S., Gonzalez J., Cirera X., Sandi M., "Potential Effects of the Proposed Transatlantic Trade and Investment Partnership on Selected Developing Countries", CARIS – University of Sussex, pp. 15-16.
- [3] Rollo J., Holmes P., Henson S., Mendez M., Ollerenshaw S., Gonzalez J., Cirera X., Sandi M., "Potential Effects of the Proposed Transatlantic Trade and Investment Partnership on Selected Developing Countries", CARIS – University of Sussex, pp. 23.
- [4a] Ulgen S., "Locked in or left out? Transatlantic Trade Beyond Brussels and Washington", Carnegie Europe, 2014, pp. 6-8, 15-16.
- [4b] Berger A., Brandi C., "What Should Development Policy Actors do About the Transatlantic Trade and Investment Partnership (TTIP)?", DIE, 2015.
- [5] Manrique M., Lerch M., Bierbrauer E., "The TTIP's potential impact on developing countries: A review of existing literature and selected issues", European Parliament – DG for external Policies, 2015, pp. 10-11.
- [6] Aichele R., Flebermayr G., Heiland I., *Going Deep: The Trade and Welfare Effects of TTIP*, CESifo Working Papers, 2014, pp. 2-3.
- [7] Draper P., Mendez-Ortiz R., *The Trans Pacific Partnership (TPP) and the Trans-Atlantic Trade and Investment Partnership (TTIP) – Key issues and Potential Impact on Members*, World Economic Forum, 2014, pp. 14-15.
- [8] Dadush U., "Mega-regional Trade Agreements Game Changers or Costly Distractions for the World Trading System?", World Economic Forum, 2014, pp. 28-30.
- [9] Berger A., Brandi C., "What Should Development Policy Actors do About the

- Transatlantic Trade and Investment Partnership (TTIP)?", DIE, 2015.
- [10] Berger A., Brandi C., "What Should Development Policy Actors do About the Transatlantic Trade and Investment Partnership (TTIP)?", DIE, 2015.
- [11] Francois J., "Reducing the Transatlantic Barriers to Trade and Investment", Centre for Economic Policy Research, London, 2013, pp. 81.
- [12] Freytag a., Draper P., Fricke S., "The impact of TTIP", Volume 1, Konrad Adenauer Stiftung, 2014, pp. 15-18.
- [13] Freytag a., Draper P., Fricke S., "The impact of TTIP", Volume 1, Konrad Adenauer Stiftung, 2014, pp. 18.
- [14] Akman M., Evenett S., Low P., "Catalyst? TTIP's impact on the Rest, CEPR Press, 2015, pp. 27-29.

## TTIP and the Implications for the Negotiation Process

Ioana Gutu

Alexandru Ioan Cuza University of Iasi

[gutu.ioana@yahoo.com](mailto:gutu.ioana@yahoo.com)

### Abstract

*The Transatlantic Trade and Investment Partnership – TTIP is considered to become after its negotiations will be concluded, the largest bilateral trade and investments agreement ever agreed. The responsibility of talking over such a Treaty, belongs to the officials that activate within the European Commission – Directorate General for Trade and the United States Trade Representative – USTR. For its ratification and implementation, additional approvals will be needed: for the European side, it is required the approval of the European Parliament, seen as representing the opinion of the Member States, and on the American side, the agreement of both the Senate and the House of Representatives. TTIP held in October 2015 its 11<sup>th</sup> negotiation round, and according to the officials that are debating on it, is expected to be fully negotiated until the beginning of 2016. In the light of these facts, responsible for its implementation will be the negotiating structures, through the personnel formed of specialized diplomats that activate within.*

**Key words:** diplomacy, TTIP, EC, USTR

**J.E.L. classification:** F 02

### 1. Introduction

TTIP as the Transatlantic Trade and Investment Partnership is a currently negotiated agreement between the European Union (EU) and the United States of America (USA), primarily focused on investment and trade regulatory issues. The talks began in 2013, under the coordination of European Commission – EC (for the European side), that is responsible with the evolution of the negotiations, as well as with the composition and identity of the negotiating teams and additional experts that were consulted along the process. Recently, TTIP reached 11

rounds of negotiations, proposing a glowing change in the evolution of the economic diplomacy in a globalized world.

The specific of TTIP is represented by the lack of transparency and the politics kept by the negotiators, the one of representing entities on a supra-national level; the negotiators are diplomats that act within the EC or the United States Trade Representative – USTR (the responsible with TTIP negotiations for the US side), that have expertise in one of the domains relevant for the 24 chapters of the agreement.

The main objective of negotiating TTIP is creating a stronger bond between the EU and the US economies by liberalizing trade and discouraging the other states that might undermine the traditional transatlantic economy. Due to the current international relations features, the classic diplomacy has to adapt, as TTIP actions occur.

### 2. The chronology of launching the negotiations on TTIP

From a European perspective, TTIP is being negotiated on behalf of all the 28 Member States by a single authority i.e. the European Commission (EC) that acts through the help of the experts coming from Directorate General Trade (DG Trade). This fact is supported partly by the EU legislation (the Treaty on the Functioning of the European Union, abbreviated as TFEU) Art. 207, that gives to the EC the exclusive power of coordinating trade and investment policy in regard with the extra communitarian countries “only the EU, and not individual member states can legislate trade matters and conclude international trade agreements”[1]

As Novotna [2] points out in her paper, the urge of launching TTIP negotiations came from the EU Member States, even though at a European level, the Commission was somehow pushed to agree with the

Council's conclusions and launch the negotiations.

The timeline of launching the negotiations on TTIP started with the EU-US Summit in 2011, which determined the DG Trade to cover all the needs the EC might have in regard to the potential negotiations of TTIP. The Summit was the starting point in connection with the procedures to follow, because it established the High Level Working Group (HLWG) that had as leaders from the European side – EU Trade Commissioner Karel de Gucht and representing the American interests – the US Trade Representative (at that time, Ron Kirk). The issue lead and experts were grouped according to the topics discussed and the members areas of expertise, in nine clusters of issues [3] as the interim report from 2012 (High Level Working Group on Jobs and Growth, 2012) and the final report in February 2013 (High Level Working Group on Jobs and Growth, 2013) showed. The next step was the approval of the HLWG report by the EC and the European Council, and from the President of the United States.

The process continued with the procedures launched by the EC of obtaining a negotiating mandate from the EU Member States (MS) that circulated under the form of a draft mandate that was the subject of many amendments and national discussions. This mandate was signed before June 2013 by all the MS, but it was not made public before January 2015, when under the public pressure, the EC also published on its official website specific proposals in regard with the course of the negotiation rounds and TTIP negotiation chapters on the table. After the EC send the amended mandate to the Council, it approved it and gave its official permission for the TTIP talks to begin, on 14 June 2013.

The implications of the European Parliament within this process were somehow reduced to minimum, even though in the scenario when TTIP negotiations will be concluded, the members of the EP will have to assent to it. It made its voice heard firstly in May 2013, when it adopted a resolution [4] concerning TTIP, two months after the EC conceived and send to the MS the draft mandate, and one month before the Council's approval of launching the talks. The second and last action that the EP took

considering the TTIP negotiations, was publishing a review of the talks which was led by the Parliament's Committee on International Trade and 14 other parliamentary committees, where the members of the EP voted the EP position in relation with TTIP [5]. This review was followed by a set of recommendations for the negotiating team of the European Commission and a release of the Directives for the negotiation [6], stressing out that even though the MEPs do not take part actively to the negotiating sessions, they have a provisions that they would like to see at the end of the TTIP talks. [7]

The TTIP negotiations were officially launched on 17 June 2013 with the occasion of G8 Summit, where officials like EC President Jose Manuel Barroso, European Council President Herman Van Rompuy and US President Barak Obama were attending.

The first negotiation session took place in Washington DC and lasted for five days; within this time, the negotiating teams have gotten familiarized with the negotiating topics and tried to equilibrate the national power of the opposite team. The next two negotiating rounds had almost the same effect and role for the members of the teams, the meeting from December 2013, marking the end of the initial phase of the negotiations. Another important event that occurred in parallel with this round, was the consultations meeting of one Advisory Group whose aim is to provide the negotiating teams with additional expertise in the sensitive areas. This Group is chaired by the EU Chief Negotiator Ignacio Garcia Bercero, and is designed to meet every two months, in-between the negotiating rounds. The members are heads of national and international Bureaus that activate in a range of interest areas and that have expertise of the relevant subjects from the three main areas TTIP text is designed to touch. [8]

Right from the beginning of the negotiations, the Civil Society organizations were involved through a series of dialogues that occurred on the last day of negotiation rounds; it must be mentioned that the frequency of these meetings decreased once the subjects negotiated became more sensitive and technical. From December 2013 to July 2014 the Civil Society Dialogue (CSD) was evaluated by an independent

agency for the EC – DG Trade, in order to determine the relevance of the objectives, the effectiveness and to issue a series of recommendations in regard with improving and renewing the progress and the way the talks were handled by the officials and by the civil society's interested members [9]. On the conclusions, they emphasized the lack of transparency of the released documents and the fact that it represented a limitation for the talks, suggesting that the European Commission is reluctant when taking up the civil society's observations in a meaningful way, rallying in this way to the public's opinions on the matter.

Until November 2015, a number of 11 rounds of negotiations took place, the last one taking place from 19 to 23 October on US ground, where important progress has been made and text proposals presented, from the both sides. By the end of 2015, a twelfth round of negotiations should take place, so that at the beginning of 2016, the TTIP agreement shall be concluded and respect the initial plan. So far, it does not exist any official information in regard with the events that might take place until the end of the year.

### **3. The implications over the negotiating entities**

The transatlantic relations have a long and loopy history across time, but the current events are being managed under the attention of two representative structures of the two economies: the European Commission (EC) on one side, and the United States Trade Representative (USTR) on the other. The processes are different on both shores of the Atlantic, including different measures and courses of action that have to be accomplished in order to ensure legality.

The Directorate General for Trade of the EC is supported in its activities by specialists from other DG, within an so-called inter-service consultation process; the Service cannot take an official position if there are disagreements between the members co-involved within this activity, the aim being the one of reaching a consensus among the way the EC involves its services in the current agenda.

When about the intra-services that, mainly regard the decisions that involve the Member

States, the process is legally supported by the accession Treaties of all these entities, as well as the functioning EU agreements that the member states agreed on. This requires that in the case when a bilateral agreement like TTIP is being negotiated, the draft positions and all the relevant papers that result from the negotiation process are being send to MS in order to be commented and amended with individual remarks and requests. All these decisions taken on EU level are being supported by the Council's Trade Policy Committee, that has regular meetings at technical and senior level, where current issues are under debate. But this cordial process does not suppose on the official level any compulsoriness for any of the involved parties – Member States and/or the TTIP negotiators, both of them being entitled not to take into consideration each other's suggestions.

The TTIP process involves also EC officials meeting sessions with the MS representatives, this process being described as a "subtle exercise" [10]. On a great importance in negotiating trade deals is also the role of Presidencies of the European Union, that are interested in achieving under their mandates such deals, in order to offer them visibility; but in the case of TTIP, this system is not working that well, because they cannot propose negotiating agendas nor draft negotiating texts, since in this case the full competency belongs to the Commission. The only active involvement they have, consists in chair meetings with the Council and discuss TTIP trade related issues. It is important to point out that the EU Presidencies change once every six months, and that the envisaged agendas may or may not include issues related to such a long process like negotiating TTIP, that is lasting for more than two years now.

### **4. The negotiating process**

The TTIP negotiation process differs for both of the international powers involved, so that for the European Union a double consultation process is needed, while for the United States an additional third step is required. The first two steps are reciprocal: after the consultations with the Commission and reverse, the position papers are drafted and send to an inter-agency analysis, after the

draft is complete, it is being officially sent to the US Congress and or the European Council and verified by both, the House of Representatives and the Senate. Even though after the Council's approval, in EU the negotiations can be launched, in the US another third step follows: the TTIP position paper is shared in a secure and non-disclosed way to the Advisory Committee for Trade Policy and Negotiations (ACTPN) where it is examined for a maximum of ten days and a feedback is given. Only after the completion of this third layer of consultations, the TTIP position paper was presented to the European counterparts. As TTIP is an EU –US trade deal, it is obvious that it is a matter treated on a supranational level, so that the European Member States do not have the right to any interference within this process.

After the completion of explaining the procedures of negotiations of an international level, explanations may be necessary about how the actual negotiating process works. It is already widely known that the negotiators meet for about once on a two months for a week-long session, alternatively between Brussels and Washington. There are two large negotiating teams, each representing EU vs. US points of view and interests. Additional Civil Society Dialogues alternatively with meetings with a Group of Experts (starting with 2014) occur in between the negotiation rounds. The negotiation teams are formed of diplomats that act for the EC - DG Trade and for the USTR. Their areas of expertise are wide, covering the issues captured in all the 24 chapters of TTIP, grouped in three main areas of interest: market access, regulatory cooperation and rules.

Negotiations work by following a strict scale of steps to be followed: (i) initially, broad position papers are exchanged by both of the parties, with the role of presenting goals and expectancies from finalizing the talks; (ii) initial offers represent a sign of trust among the two international entities, because these offers represent the extent of which the negotiations will open their markets; they are presented under the form of textual proposals offered by one part to the other, offers that will be studied and agreed or modified until the next round of negotiations; (iii) based on the texts presented in the earlier phase, consolidated

texts are issued, mainly formed of the two positions initial offers and accepted amendments commonly joined; (iv) the last phase implied discussions on the objections and the content of the consolidated text on the specific issue under debate [11]. Regarding this process, the TTIP negotiations are now at an advanced stage, in the 11<sup>th</sup> round of talks which took place in October 2015, resulting in numerous text proposals and consolidated texts that are ready to be part on the whole TTIP agreement.

The TTIP negotiation process will continue until an agreement is reached, and will be followed by the final text's ratification and implementation by both of the entities involved. The climax of TTIP effects is expected to be reached ten years after it started to be implemented, optimistically until 2026.

## 5. Final remarks

Even though TTIP is presumed to be the largest and most advantageous bilateral treaty ever attempted, the lack of transparency of the negotiations, together with the large load of negotiation chapter that have to be agreed on, makes the process to shift from the economic benefits to the political implications that characterize the talks. The paper tried to review the process that gave birth to the negotiations, especially after the failure of the Doha Round and the threatening positions of the emerging economies that began to capitalize the world trade. Secondly, there was a description of the participation of the European structures and their homologues, in regard to the negotiation process and responsibilities; the last part of the article offered a perspective on how the TTIP negotiations work and the procedures to be followed in order to reach a consensus within the negotiation rounds.

It is important to notify that the implication of the Member States in the negotiations, as well the one of the European Parliament is reduced to minimum, these structures being satisfied with following the process from aside, given the fact that there will be no agreement without the European Parliament consent. The Member States though showed a light of dissatisfaction when about the way the European Commission manages the state of play and allows their

opinions to be considered. Therefore, the paper argues that TTIP is an agreement negotiated on a supra-national level, the European Commission through the specialists that activate within DG Trade and the other relevant Directorates General considering only the Union interests and perspectives, and leaving on a side the special interests of the individual member states.

Nevertheless, it is to be noticed that TTIP is designed to improve the MS economies, to maintain the existing bilateral relations with the United States and to encourage and facilitate openings of such relations in the near future. For these considerations, national embassies together with the European External Action Service (EEAS) will be needed to maintain and improve their diplomatic relations with the US.

Together with TTIP negotiation priorities, the European Commission enhanced a long way in its approach toward diplomacy; EC is one of the two main responsible entities for implementing and making TTIP a success, therefore, together with the USTR, they will be responsible on all the diplomatic actions that will derive from agreeing over TTIP on the transatlantic market, together with third parties accession issues that for the moment are kept aside from the negotiations, and no link towards this possibility has been made.

## 6. References

- [1] European Commission – DG Trade, What is trade policy?, 2013, available at: <http://ec.europa.eu/trade/policy/policy-making/>.
- [2] Novotna T., The European Union and the United States, A long Walk to the Transatlantic Trade and Investment Partnership (TTIP), 2015, pp. 4.
- [3] EU-US High Level Working Group on Growth and Jobs, Issue Leads and Experts, available at <http://corporateeurope.org/sites/default/files/hlwg-members.pdf>.
- [4] European Parliament, TTIP: spotlight on the sensitive issues at EP public hearing, 2015, available at: <http://www.europarl.europa.eu/news/en/news-room/content/20150126STO15022/html/TTIP-spotlight-on-the-sensitive-issues-at-EP-public-hearing>.
- [5] European Parliament Research Service, TTIP: EP reviews EU-US Trade Negotiations, 2015, available at:

- <http://epthinktank.eu/2015/02/26/ttip-ep-reviews-eu-us-trade-negotiations/>.
- [6] Council of the European Union, Directives for the negotiation on the Transatlantic Trade and Investment Partnership between the European Union and the United States of America, Brussels, 2014, available at: <http://data.consilium.europa.eu/doc/document/ST-11103-2013-DCL-1/en/pdf>.
- [7] European Parliament Research Service, TTIP: EP Recommendations For An EU-US Trade Deal, 2015, available at: <http://epthinktank.eu/2015/07/14/ttip-ep-recommendations-for-an-eu-us-trade-deal/>.
- [8] European Commission, Register of Commission Expert Groups and Other Similar Entities, 2015, available at: <http://ec.europa.eu/transparency/regexpert/index.cfm?do=groupDetail.groupDetail&groupID=2988&NewSearch=1&NewSearch=1>.
- [9] Coffey International Development, European Commission – DG Trade, Evaluation of DG Trade's Civil Society Dialogue, 2014, available at: [http://trade.ec.europa.eu/doclib/docs/2014/december/tradoc\\_152927.pdf](http://trade.ec.europa.eu/doclib/docs/2014/december/tradoc_152927.pdf).
- [10] Novotna T., The European Union and the United States, A long Walk to the Transatlantic Trade and Investment Partnership (TTIP), 2015, pp. 6.
- [11] Culture Action Europe, A little guide through TTIP negotiations, 2015, pp. 6-7.



# The Romanian Chambers of Commerce, Representative Organizations of Entrepreneurs. The Example of Constanta Chamber of Commerce

Ion Danut Juganaru

„Ovidius” University of Constanta, Faculty of Economics

[juganarudan@yahoo.com](mailto:juganarudan@yahoo.com)

Mariana Juganaru

„Ovidius” University of Constanta, Faculty of Economics

[juganaru.mariana@yahoo.com](mailto:juganaru.mariana@yahoo.com)

## Abstract

*In a market economy, the chambers of commerce represent an important component of the external environment of any company, due to their assumed role in supporting and stimulating the whole economic activity in the regional, national and international area.*

*Concerns for setting up institutions that defend the interests of merchants, of guilds, existed in the economic developed countries many centuries ago, and in 1599 was founded the world's first Chamber of Commerce, in Marseille.*

*In this article, we intend to present a brief overview of the history of the general evolution of this institution, in Romania, but we will focus our study on the example of Constanta Chamber of Commerce. We consider that, through the activities it performs (locally, nationally and internationally), this organization brings an important contribution to the development of the business environment.*

**Key words:** chamber of commerce, evolution, involvement, business environment

**J.E.L. classification:** L310

## Introduction

The economic activity takes place within companies, but the success or failure of an economic unit depends on both the management and the strategies adopted, and the influence exerted (at national and international level) by the environmental forces, of different nature: economic, social, political, cultural, demographic, natural and

technological. Companies are becoming increasingly aware that they do not act separately, but in a complex and dynamic environment. [1] The representatives of the business environment (industrialists and merchants, in particular) have realized a long time ago, the need to establish an organization that would support their interests and would represent them in relation to the state institutions. In this context, the chambers of commerce emerged and developed. Nowadays, they exist in every country with a functional market economy and, depending on the specific legal framework, they can be established at local/regional, national, bilateral or international level.

## 1. Highlights in the history of the Chambers of Commerce

The first institution of the world, known as the Chamber of Commerce, was founded in 1599 in Marseille, France. The aim of setting up this institution was "... to control and protect commercial businesses and thus, to restore and preserve their old situation and brightness, as well as to guard them from any unrighteousness (...) either from the indigenous or foreign authorities, or from individuals. [2] Later, in 1805, under the reign of Napoleon, it was founded what today is called the Chamber of Commerce and Industry of Paris. [3]

In Romania, the first Chambers of Commerce have emerged since the nineteenth century, in Transylvania. Thus, in 1850, there were established Chambers of Commerce in Brasov, Cluj, Timisoara and then appeared in Arad, Oradea and Targu Mures. [3] We can explain the appearance of

the first Chambers in Transylvania, given the higher level of economic development in this area, the influences of the Habsburg Empire domination, the presence of foreign investors. What is surprising is the aspect that, in Romania, the establishment of the Chamber of Commerce occurred in 1864, long before the appearance of the first Chamber of Commerce in London (1882).

In the Romanian Principalities, Stefan Golescu, a young man coming from the Romanian bourgeoisie of Walachia, with studies completed in Switzerland and returned in the country after 1857, during the reign of Cuza, became minister of finance and proposed to itself, among its projects, also the establishment of the Chambers of Commerce on the territory of the country. Even if his project was supported by the merchant guilds and corporations, he didn't receive support from the Legislative Assembly in Bucharest and Iasi. [4] In 1859, the merchants were preoccupied with the establishment of a chamber system, that should have had "independent action and recognized authority, in order to be able to defend more effectively the vital interests of all industrial branches" (C.A. Rosetti, prime merchants guildmaster of the Capital). [5] Then, in 1863, the Minister of Agriculture, C.A. Rosetti sent to the Legislative Assembly a new proposal for the establishment of Chambers of Commerce. [4] On September 30<sup>th</sup> 1864, Prince Alexandru Ioan Cuza signed the Law of the Chambers of Commerce in the Romanian Principalities. [4] Through this law, there were established fifteen Chambers of Commerce, in: Turnu-Severin, Craiova, Turnu Magurele, Giurgiu, Braila, Galati, Ismail, Barlad, Iasi, Piatra-Neamt, Bacau, Focsani, Botosani and Ploiesti. We have to mention that, at that time, Dobrogea was not part of the Romanian Principalities. By setting up these institutions, it was intended the connexion with the Western capitalist economic system, which became, after the second half of the XIX century, a political, economic and cultural model of the Romanian Principalities. [4] In 1925, in Romania, there were 68 counties and 32 Chambers of Commerce established and through the third Law of the Chambers of Commerce, from 1925 (promulgated by King Ferdinand), it was decided to: increase the number of

Chambers of Commerce, enhance their duties and organizing them into the Union of Chambers of Commerce and Industry, economic organization with general nature. [4], [6] The Act from 1929 for amending the Law of Chambers of Commerce and Industry, provided the establishment of 43 Chambers, and the one from the Constituency No. 18, was Constanta Chamber of Commerce and Industry. During 1925-1929, in Romania appeared 11 new Chambers of Commerce, as a recognition of the role of this institution in supporting the business environment, in a period of economic development of Romania.

For Dobrogea region, the situation was something special, because this area was under Ottoman occupation and it was attached to the Romanian Principalities only after the War of Independence (1877-1878). Shortly thereafter, in 1880, the Chamber of Commerce of XV Constituency was established. In the act of establishment it was stated: "Constanta Chamber of Commerce takes the name of the Chamber of Commerce of the XV Constituency, with its residency in Constanta, including Constanta and Tulcea counties. The purpose of founding the Chamber of Commerce of XV Constituency was to protect the interests of merchants and industrialists in the area between the Danube and the Black Sea and to stimulate their economic activity. [3] The Chamber's Constituency suffered frequent changes, over time, in terms of its structure, as follows: during 1880-1910 the Constituency included Tulcea and Constanta counties, then, during 1910-1914 it was limited only to Constanta county; during 1914-1924 it was expanded, covering Constanta, Durostor and Kaliakra; during 1924-1926 period, it included Constanta and Kaliakra, then, between 1926-1934, it returned to an older structure, which included Constanta, Durostor and Kaliakra; in the last period, between 1940-1949, it covered only Constanta. [3]

## **2. The role of the Chambers of Commerce in Romania**

In the history of this institution, several laws, issued in 1864, 1886, 1925, 1934, 1949, 1973, 1990 and 2007 have regulated its activity, depending on the economic and

political conditions. [5]

The Chambers of Commerce performed their activity under the laws adopted in different moments in time, but on the other hand, the Chambers have initiated or proposed various laws that they considered necessary for a proper course of their economic activity and needed to support the businessmen that they were representing. The Chambers of Commerce in Romania were imagined, from the very beginning of their existence, as institutions having the role of partner in the dialogue with the state bodies. Also, according to the Law from 1864, the chambers had a double mission: advisory and administrative. Regarding exercise their advisory mission, the chambers had to present to the government and to the public administration information about the interests and the activities of merchants and industrialists in their constituencies. The administrative mission of the chambers regarded the management of several economic objectives in their constituencies, as, for example: sea and river ports, free areas-in ports, shipping channels, trade stock exchange, fairs, commercial and industrial museums, commercial and industrial schools. [2] To assert these statements, regarding the chamber's mission, we mention, hereinafter, some of the most significant steps of Bucharest Chamber of Commerce: in 1868, it starts the foundation of the Register of Commerce (which solves the tabulation issue of commercial enterprises); in 1870, the Chamber is authorized to publish the average exchange rate of the key foreign currencies; in 1875, it was involved, as a co-author, in the writing of the content of the first law regarding trademarks; in 1884, the Chamber proposed the promulgation of the Law regarding the stimulation of domestic industry; in 1886, through the Second Law of Chambers of Commerce (during King Carol I) it was managed their release from the government authority; in 1895, the Chamber opens the first office of commercial information, which will enjoy fast, of outstanding trust and appreciation, from foreign companies that worked in those days, in Romania; in 1899, the Chamber makes public its position regarding cartels; in 1926, proposes to be introduced the check post, as cashless payment instrument. [4] [5]

In the Romanian Kingdom, the activity of

the Chambers of Commerce has become increasingly more important and correlated with the economic realities of the time. The Romanian Chambers of Commerce left their mark on the first commercial and industrial forms of education, have developed international relations with similar institutions in other countries, have contributed to trade liberalization, modernization of transport and communication, expanding and strengthening the internal market. [4]

Regarding the Chamber of Commerce of the Constituency XV of Constanta, starting with the main purpose of its activity, to defend the interests of merchants and industrialists of the area between the Danube and the Black Sea, the Chamber was organized into several sections, namely: Grains trading, Clothing trading, Oil, derivatives and timber trading, Various tradings, Small trading, Credit and insurance, Food industry, Various industries, Small industry. To be mentioned that all the companies in these fields were members of the Chamber. In the same time, were members of the Chamber of Commerce all the senators and deputies in the constituency. [3]

This organization of the Chamber reflected the structure of the economic activity in this area, during that period of the national economic history. When choosing these sections of the Chamber's structure, it was took into consideration also the geographical location of Dobrogea, between the Danube and the Black Sea, two very important natural resources, with the potential to develop certain economic activities, and also important means of transportation of the goods that were imported and exported, not only for Romania, but for other countries, too.

As main responsibilities of the Chamber, since its establishment, we shall remember: registration of companies (much later, in 1931, it was established the Register of Commerce in Constanta), organization of markets and fairs, fixing the custom tariffs, participation in signing the working collective contracts, compilation of statistics, the establishment and the support given for several commercial and vocational schools. [3]

Regarding the legislative steps undertook

by Constanta Chamber of Commerce (among those that were recorded over time and have been found), we shall mention, hereinafter, some of them. Thus, Constanta Chamber was consulted, in 1929, on the draft amending the Law of Chambers of Commerce and Industry (from 1925), and the observations made by the Chamber regarding the content of this project were discussed within the Union of Chambers of Commerce, but were also submitted to the parliamentarians of Constanta, in order to be presented during the debate on this law. In the same time, Constanta Chamber of Commerce proposed some necessary practical aspects, to support the business environment of that period, such as: changing the tax on luxury and turnover, requiring a significant reduction for the stamp and the registration fee, the transport (buses) fee, the consumption fee; the Chamber asked canceling the tax on luxury and the tax on turnover for artisans and small industrialists; reduction of quotas and taxes for merchants and industrialists. In 1934, after the entry into force of the fourth Law of Chambers of Commerce and Industry, in the local newspaper "Vointa Dobrogei" from March 4<sup>th</sup> 1934, it was published an article stating that at the meeting organized for the establishment of the Interim Commission of the Chamber of Commerce (on the occasion of the enforcement of the new law and the reorganization of Constanta Chamber, which was expanding, covering Durostor and Kaliakra counties, as in the period between 1914-1924), there were discussed the successes achieved in terms of simplifying the tax system, reducing the tax on luxury and turnover, reducing the local taxes of all kinds, which were levied by Constanta City Hall from merchants, obtaining tariff reductions from CFR (Romanian Railways) in order to facilitate the transport of goods through Romanian ports and to discourage the competition of foreign ports, steps to recede electricity in Constanta, as well as other actions that contributed in sustaining the interest of industry and commerce in this county.[3] Also from the press from that time (Dacia newspaper, from June 22<sup>nd</sup> 1926), we find out about other undertakings made by Constanta Chamber of Commerce, such as: interventions submitted to the City Hall, to give the Chamber the profits that came from

the stockyard, so that, in this way, to be created the revenues needed for the modernization of grain market, the construction of two roads, linking Murfatlar and Anadalchioii markets; steps to change the trains time table on Bucharest-Constanta route, according to the interests of merchants [3]. As another example, in a newsletter called "Dobrogea Economica", no.112-113 from September 1-15<sup>th</sup> 1939, there are mentioned some steps taken by Constanta Chamber, towards the City Hall, for the development and modernization of the grain market, of the cattle fair, the development of the food market, both the wholesale and the retail markets, the development (increasing the assigned area of land, expanding networks and means of transport) and modernization (setting up docks, cold air equipment, offices, etc.) of markets. It may seem surprising, but most of these concerns of the Chamber, will be met again after its re-establishment, in 1990, after an interruption of 41 years, and some of those concerns are still, currently, in the attention of the Chambers' management.

In the first period of its existence (until 1949, when it was disbanded), Constanta Chamber of Commerce has initiated various actions through which it got itself noticed, locally, regionally and nationally. Thus, in 1922, Constanta Chamber of Commerce organized the first Congress of Chambers of Commerce and Industry in Romania. On the occasion of this congress there were discussed different issues about the free trade and the limitation of state intervention in commerce and industry, the reorganization of the Chambers of Commerce, grain export regime, new taxes, the reorganization of commercial education, transport organization, enhancement and reorganization of ports, the unknown companies system. [3] Also in the press from that period (in the newsletter "Dobrogea Economica" no. 67-70 from June 1<sup>st</sup> 1937 issued by Constanta Chamber of Commerce and Industry), it is recorded that in May 1937, it was founded the Federation of Dobrogea Chambers of Commerce, with its head office in Constanta, having as members the Chambers of Constanta, Tulcea, Durostor and Kaliakra. The purpose of this federation was to protect better the specific economic interests of this region, which at that time,

aimed: sustaining the commercialization of specific Dobrogea products, such as wool, sheeps, textile industry, horses, durum wheat of Durostor; development of fishing and mining (the area being rich in deposits of granite, kaolin, stone); construction of communication/transport means between Tulcea-Babadag, Techirghiol-Mangalia and the connection with Silistra-Calarasi route; increasing the use of coast little ships between southern Bessarabia and the Danube, and between Southern Dobrogea and Constanta, for grains shipping, for the decongestion of railways, etc. The Federation of Dobrogea Chambers of Commerce represented a center of power and influence in the economic and professional life, not only in this area, but also nationwide.

Through the Decree no. 74 of November 25<sup>th</sup> 1949, all the county chambers of commerce of Romania were abolished. The Romanian Chamber of Commerce and Industry was the only one kept, but passed under the Ministry of Foreign Trade and mainly, dealt with the organization of Romania's participation in international fairs.

### **3. CCINA Constanta - representative institution of market economy**

After 1990, the multiple changes occurred in the political and economic system of our country, have generated changes, including regarding the organization and functioning of the chambers of commerce.

Through the Decree-Law no. 139 from 1990, the system of Chambers of Commerce and Industry of Romania was re-established and by the Decision no. 799 of July 23<sup>rd</sup> 1990, the Government recognizes the establishment of Constanta Chamber of Commerce, Industry and Shipping [3]. After a short time, due to a special involvement of the Romanian Chamber of Commerce and Industry, it was founded (under Law no. 26/1990) the Trade Register (having one county office attached to every county chamber). Due to its economic particularities and to better represent the interests of the member companies, of all the county Chambers, only Constanta Chamber has in its name the words Shipping and Agriculture (the current complete name of the organization is Constanta Chamber of Commerce, Industry, Shipping and

Agriculture - CCINA).

The organizational structure and the responsibilities of CCINA changed from 1990 up to now, according to the amendments of the legislative framework, and also as a result of a continuing concern for the improvement and modernization, so that, through its initiated activities, Constanta Chamber of Commerce managed to be in the public eye as a representative institution of Constanta county, but also at regional and national level.

As a result of the concerns to develop itself as a market economy institution, heavily involved in supporting the business environment, CCINA founded: The Commission of Commercial Arbitration (1993), The Centre for Business Information (in 1994), the subsidiary of The Foundation "Romanian Business School" of Romanian Chambers of Commerce and Industry (in 1994), The Foundation for Supporting Private Small and Medium Enterprises of Constanta (1994), The Assistance Office for Companies (1999), The Regional Centre for Industrial Property Protection (founded in 1999 with the support of the State Office for Inventions and Trademarks), The Office for Business Advice and Regional Development (2001), The Stock Exchange Terminal of Constanta (following the signing of the contract with the Romanian Commodities Exchange Bucharest, 2003); The Agency of the Romanian Centre for Foreign Trade (opened in 2004), The Center for Technological Information (founded in 2009 under the Ministry of Research and Innovation - National Authority for Scientific Research). [3]

Through the efforts for accessing funding from European programs, CCINA managed to create new structures, which contributed to the development of its activity. Thus, with co-financing from European funds, there were established: Euro Dobrogea – Resource Center for Business and Innovation Romania-Bulgaria (completed in 2009), The Office for Information and Entrepreneurial Support (founded in 2010, with funding from the European Social Fund, through the Sectoral Operational Programme Human Resources Development), Enterprise Europe Network Center, created in 2004, and in 2008 CCINA, as coordinator of a consortium, won the tender organized by the European

Commission to cover the EEN activities in South-East and North-East of Romania. Since its re-establishment, in 1990 and up to now, in order to support the business environment from Constanta county, CCINA founded or became a partner in a large number of organizations, associations, foundations or companies.

CCINA made itself noticed, through its activity, also internationally. In this regard, we shall remember: the establishment, in 2011, within CCINA, of the Romanian-Bulgarian Center for economic cooperation BU.RO.COOP and of the Association for Cross Border Cooperation; the foundation in 2012, of the Black Sea Tradenet Center, designed to facilitate the cross border cooperation for a sustainable development in the Black Sea basin. This center is a member of a regional network, made up of seven similar centers, in 5 countries (Romania, Bulgaria, Turkey, Armenia and Greece); in 2014, CCINA, as coordinator of ERBSN consortium, won the financing of the project, through which, this consortium will continue its activities within Enterprise Europe Network (EEN) during 2015-2020; in June 2015, CCINA Constanta became a member of the Danube Chambers of Commerce Association and, as a result, it will be involved in cross-border cooperation programs and allocation of funds which aims the development of the Danube Region. [3]

Another approach of CCINA, at international level, was signing, starting with 2005, cooperation agreements with several Chambers of Commerce from various countries, such as: Busan (South Korea), Latakia (Syria), Aegean region, Antalya and Eskisehir (Turkey), Jeddah (Saudi Arabia), Shanghai and Anhui Province (China), Brindisi (Italy), Bourgas (Bulgaria). [3]

## Conclusions

We have presented in this study, some of the most important concerns and achievements of an institution whose role and mission can have a significant impact in the economic, social and cultural development of a region or a country.

In 2015, CCINA Constanta celebrated its 135 anniversary since the establishment of the first Chamber of Commerce of Dobrogea,

with its head office in Constanta (in 1880) and 25 years since its re-establishment. Regardless of the name it had, in different periods of its history, Constanta Chamber of Commerce managed to define itself as an institution able to bring together a large number of representatives of the business environment, to understand their needs and expectations for the development of their activity, from different sectors, in order to sustain them, through the steps made along various state institutions.

After 1990, CCINA's activity experienced a continuous diversification, due to the way in which the Romanian economy evolved, due to the changes of international political and economic conjuncture, due to the growth of globalization trends, but also due to the changes occurred in the business environment.

CCINA Constanta, through its activities (especially those related to the organization of fairs, exhibitions, forums and economic missions, development of cooperation between the economic and the academic environment, accessing European funds for developing various important projects for the business environment) became, currently, an institution with national and even international recognition, and the future changes in the national and international business environment will determine new challenges for the activity of this institution.

## References

- [1] Kotler, Ph.; Armstrong, G., *Principiile marketingului*, IV edition, Teora Publishing, Bucharest, 2008
- [2] Bacau Chamber of Commerce and Industry, <http://ccibc.ro/despre-noi/scurt-istoric>
- [3] Juganaru, I.D., coord., *Monografia Camerei de Comerț Constanta*, Dobrogea Publishing, Constanta, 2015
- [4] Romanian Chamber of Commerce and Industry, <http://ccir.ro/istoric/>
- [5] Bucharest Chamber of Commerce and Industry, <http://www.ccib.ro/ro/CCIB/4/2/4/istoric>
- [6] Juganaru, I.D., coord., *Monografia Camerei de Comerț Constanta*, Dobrogea Publishing, Constanta, 2010

# The Evolution of Creativity Trend of Students of Transilvania University

Dana Adriana Lupşa-Tătaru  
Transilvania University of Braşov  
[lupsad@unitbv.ro](mailto:lupsad@unitbv.ro)

Florin Răzvan Lupşa-Tătaru  
Chamber of Commerce and Industry Braşov  
[florin.lupsa@ccibv.ro](mailto:florin.lupsa@ccibv.ro)

## Abstract

*The paper aims to present a study conducted among the students of Transilvania University of Braşov in order to establish their opinion regarding the link between creativity and entrepreneurship.*

*The study aims to focus on the differences between the results previously established and a new ones.*

**Key words:** Entrepreneurship, creativity, students

**Classification J.E.L.:** M10, M12

## 1. Introduction

Scientists who study creativity say it is essential to combine two modes of thinking, convergent and divergent, to have creative breakthroughs. Convergent thinking is highly analytical and focuses on arriving at one correct solution given the available data, whereas divergent thinking generates creative ideas by exploring many possible solutions.

"Creativity is the process of bringing something new into being...creativity requires passion and commitment. Out of the creative act is born symbols and myths. It brings to our awareness what was previously hidden and points to new life. The experience is one of heightened consciousness-ecstasy." [1] Innovation is how a firm or an individual makes money from creativity [2, 3, 4].

Organizations, their managers and other employees seek to create original ideas and concepts that will end up as innovations, such as new or enhanced products or services. Thus creativity is the process of generating something new that has value and before innovation, one must use creativity.

Entrepreneurs see "problems" as "opportunities," then take action to identify the solutions to those problems and the customers who will pay to have those problems solved. Entrepreneurial success is simply a function of the ability of an entrepreneur to see these opportunities in the marketplace, initiate change (or take advantage of change) and create value through solutions. [5, 9]"

Regarding the link between creativity and entrepreneurship – starting new businesses - most people think that to start a business you need a lot of money, but that is not necessarily true since the entrepreneur has to have many other qualities, like being creative.

"Entrepreneurship is more than simply "starting a business." The definition of entrepreneurship is a process through which individuals identify opportunities, allocate resources, and create value. This creation of value is often through the identification of unmet needs or through the identification of opportunities for change.

Creativity actually needs structure to flourish, but not so much structure that it is crushed. Creative problem-solving works best when harnessed with highly focused and disciplined thought. The trick is being rigorous, but not rigid, in your work.

A startup should build in ample time for divergent pathways of thinking to keep the proper creative tension with convergent modes of thinking [6].

Highly successful entrepreneurs can creatively look beyond the present and imagine possible futures for their company. If you are a Creative Thinker, you are driven to steer your business in new directions.

Whether introducing new products and services, entering untapped markets, or initiating innovative technologies or

production processes, you are constantly thinking of novel ways to propel your business forward [7].

Comfortable with the unknown and the unfamiliar, you always look for new ways to combine and recombine resources to create innovative solutions for your customers. Your creative action helps you renew your business' value proposition and differentiate it from your competitors'. It also enables you to disrupt markets by introducing new and unexpected products or by developing novel methods of doing business [8].

Creativity is defined as the balanced unfolding and converging of experience and entrepreneurship as the management of radical change. The entrepreneur is seen - in contrast to the view in mainstream economics - as a visionary activist, who is able to constructively handle the often conflicting demands of unplannable emerging situations [13, 14].

Visions, wholistic guiding images of future possibilities, are viewed as the main guiding forces in creativity and entrepreneurship and innovation as the creation of the future. Mainly concerned with the dynamic management of image and innovation, the successful entrepreneur excels in perceiving, opening up and exploiting new technological, marketing and organizational possibilities [10, 11, 12].

## 2. The study

There was conducted a study on a sample of 99 students of Transilvania University of Brasov, aged between 18 and 24, all of them having in mind starting a new business, between 2009 and 2014.

Every year, the hypothesis of the study was that there is a link between creativity and starting a new business, meaning that the entrepreneur must be a creative person.

The objective of the study was to establish whether all the entrepreneurs are creative, creativity meaning coming up with new ideas in order to improve products, services or to find other ways to use them.

The present paper is based on data provided by a questionnaire applied on the students of Transilvania University of Brasov.

There was used a stratified random sample, because the population – all the

students of the university – were stratified considering the faculties, and then it was applied a random proportional selection.

The results of the study revealed that the hypothesis was correct, every year, that there is a link between creativity and entrepreneurship.

The results of the first question, regarding the sources of creativity, revealed that the majority, thought that creativity is generated by brainstorming. Also, about 24% thinks that creativity is in your DNA, while few of them said that creativity comes from experience, or other places.

Figure 1. The results for the question where do you think creativity comes from

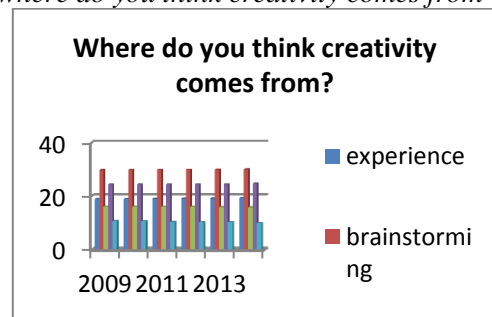

The results of the second question revealed that most of the respondents (84.8% in 2009, 86% in 2010 and 2011, 88% in 2012, 2013 and 2014) said that they have thought of unusual uses of different items.

Figure 2. The results for the second question

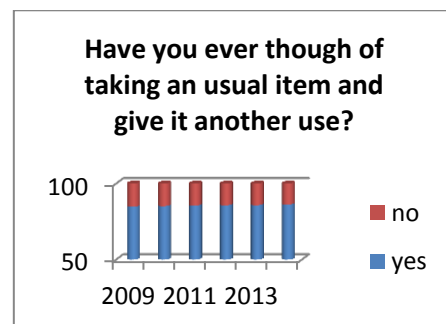

The results of the third question revealed that most of the students considered that both men and women are equally creative. The students thought that every year.



Figure 3. The results for the third question

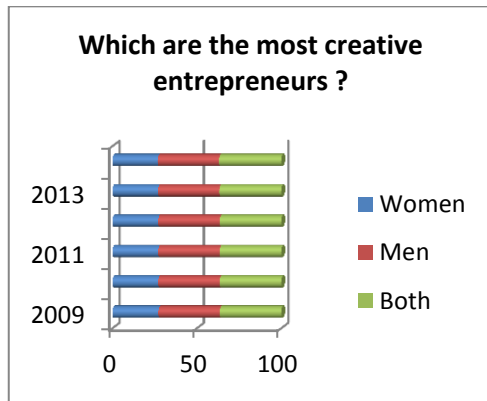

Other findings of the study included the fact that creativity is not dependent on, when starting a business, but can be an important factor in leading to success, as applying it during the evolution of the firm can only bring innovation and a constant improve.

The respondents were asked to establish whether the age was an important factor for creativity or not, and the answers revealed that the students thought that the younger they are the more creative people were.

As according to the question number four, regarding the domains that necessitate creativity, the most answered fields were "Media" and "Art", these two requiring a higher demand of creativity. These two are followed by architecture, the business environment, design, advertising, music and others.

Figure 4. The results for the fourth question

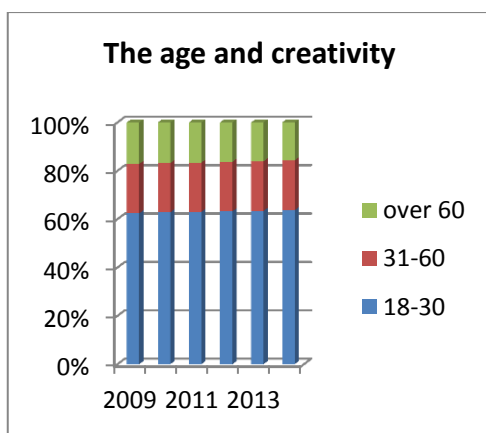

There was also used another question regarding whether creativity helps an entrepreneur in developing his firm.

Figure 5. The results for the fifth question

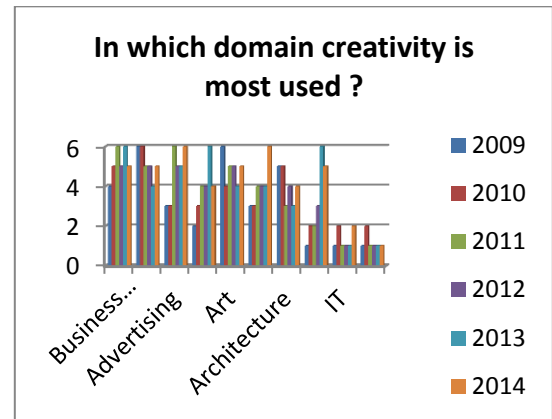

The students responded that it helps – according to figure 6, but there are also required some other qualities as an entrepreneur, not only being creative.

### 3. The conclusions

Entrepreneurship has been regarded as a major topic in the theory and practice of economic growth and development. Practitioners and politicians are well aware of the importance of entrepreneurship because a significant portion of new employment is created by new firms and often new firms bring 'productive innovation' with them.

There have been various studies on the determinants of entrepreneurship. Much of the literature on entrepreneurship has investigated the characteristics of successful entrepreneurs. These studies have attempted to explain entrepreneurship by looking into individual characteristics such as personality, educational attainment and/or ethnic origin.

The study undertaken proved that there is a strong relationship between creativity and entrepreneurship, as students consider this, according to the results. Also, the limits of the study are related to the fact that the results may not be extended to the population formed by all the students of the University, but according to theory [6, 7, 8, 9], there is also a connection between creativity and entrepreneurship, namely the entrepreneur must be a creative person in order to succeed.

#### 4. References

- [1] Baum, J.B., Frese, M., The Psychology of Entrepreneurship. Published by Routledge, New Jersey, 2007
- [2] Baron, R.A. Corbin, B. Entrepreneurial Life: Are you cut out for it?. Published by Corbin Group Publishing, 2000
- [3] Constantin, Sanda, "Gross Domestic Product and the Investment percent in Romania and in the European Union, Ovidius University Annals, Economic Sciences Series, Volume XIII, Issue 1, 2013
- [4] Gera, S., Weir, T. The Knowledge-based Economy and Economic Growth: theory and empirical evidence, New Economy Issues Paper No.3, Department of Industry, Science and Resources, Canberra, 2001, available at <http://www.industry.gov.au..> Accessed 2014-May-04
- [5] Godin, B. The State of Science and Technology Indicators in the OECD Countries, Science and Houghton, J. and Sheehan, P. 2000, A Primer on the Knowledge Economy, Centre for Strategic Economic Studies, Victoria University, Melbourne, 1996, available at <http://www.cfses.com>. Accessed 2014-May-12
- [6] May, R. The courage to create. Published by Harold Anderson, New York, 1975
- [7] Kukoc, K., Regan, D. Measuring entrepreneurship. Available at: [ww.treasury.gov.au/documents/1352/PDF/02\\_Entrepreneurship.pdf](http://www.treasury.gov.au/documents/1352/PDF/02_Entrepreneurship.pdf). Accessed: April 14, 2010
- [8] Wilson, F., Kickul, J., Marlino, D. Entrepreneurship: Theory and Practice. Published by South-Western College Pub, 2007
- [9] \*\*\* <http://www.mu.ac.in/mis.pdf>. Accessed 2014-May-02
- [10] \*\*\* <http://www.saylor.org/site/textbooks/Business%20Information%20Systems.pdf>. Accessed 2014-May-03
- [11] [http://www.mahmoudyoussef.com/aa\\_gsb/mba/mis/Lectures-2-and-3-Questions.pdf](http://www.mahmoudyoussef.com/aa_gsb/mba/mis/Lectures-2-and-3-Questions.pdf). Accessed 2014-May-08
- [12] \*\*\*<http://www.gregwatson.com/entrepreneurship-definition/>
- [13] \*\*\*<http://epp.eurostat.ec.europa.eu/portal/page/portal/statistics/themes>.
- Accessed: April 14, 2010
- [14] Journal of Small Business, Published by Canadian Council for Small Business & Entrepreneurship

# Institutional Diversity in the Post-socialist Area during Crisis

Michal Mádr

*Mendel University in Brno, Faculty of Business and Economics, Brno, Czech Republic*  
[xmadr@mendelu.cz](mailto:xmadr@mendelu.cz)

## Abstract

*The main aim of the paper is to identify the types of capitalism in the Eurasian transition economies in comparison with the other European countries and evaluate the influence of the recent global crisis on the institutional organization of these states. The paper uses cluster analysis for identifying the types of capitalism. The paper identifies 3 basic groups (core and periphery of the EEA and the other transition economies) and 10 sub-clusters in the European area. According to the results, only Estonia is at the same level as the core of the EEA, whilst the rest of the EU-8 economies and Montenegro with the Mediterranean economies comprise the periphery. In general, CEECs and EU Balkan States have higher quality institutional environment, but on the basis of the analysis of the selected indicators (economic growth, inflows of FDI and unemployment), these economies were impacted more by the recent global crisis than part of the Balkan and post-soviet countries in the clusters "2a" and "2c". For the losing economies, one can consider sub-cluster "2d" (Bosnia and Herzegovina, Russia, Serbia and Ukraine).*

**Key words:** institutional diversity, transition economies, models of capitalism, global crisis

**J.E.L. classification:** P16, P26

## 1. Introduction

Twenty five years have passed since the fall of the Berlin Wall, which enables us to undertake an evaluation of the established institutional (capitalist) settings in the European post-socialist countries. The transition countries have a high level of institutional diversity, which is provided by the diverse socialist organization heritage

(informal institutions) and the transition process. One can identify the EU-8 countries, which successfully executed the transformation process and have converged with the old EU members in most of the institutional settings. On the other hand, there are the post-soviet republics with a low quality institutional environment. Countries of the third group, the Balkan States, are at a crossroads, both relatively successful (Bulgaria, Croatia, Montenegro, Romania) and relatively unsuccessful (Albania, Bosnia and Herzegovina, Kosovo, Macedonia, Serbia).

The main aim of the paper is to identify the types of capitalism in the Eurasian transition economies in comparison with the other European countries and evaluate the influence of the recent global crisis on the institutional organization in these states. The first section comprises of a survey of the individual approaches to the varieties of capitalism, which describe the institutional diversity, the method of cluster analysis, data sources, proxies used and a sample of the studied countries. The main second section includes the results from the cluster analysis. The conclusion summarizes the major findings.

## 2. Methodology

Differences between the individual capitalist economies are given by their institutional organization. Within the research of the models of capitalism, there are two crucial works, Hall and Soskice [1] and Amable [2]. Hall and Soskice [1] provide a very general classification based on the level of coordination within market economies, which defines two basic models – *Liberal Market Economies* (LMEs) and *Coordinated Market Economies* (CMEs). Amable [2] uses five dimensions (Product market, the Wage-labour nexus, the Financial system, Social Protection and Education) and

distinguishes between five models of capitalism: *Market-based*, *Continental European*, *Social-democratic*, *Mediterranean* and *Asian*. Other important contributors are, [3], [4], [5] and [6].

If one includes the research of the transition (post-socialist) economies, one can consider [7] a pivotal contribution, which used an unusual evaluation of transition economies by putting an emphasis on integration into international trade in six parts (export-oriented FDI in complex sectors, export-oriented complex sectors without FDI, simple manufacturing subcontracting, commodity exports, dependence on remittance and aid, dependence on financialised growth), and differentiate between five models, *FDI based (second rank) market economies* (Visegrad group), *Peripheral market economies* (Balkan and Baltic States), *Oligarchic* or *Clientelistic* capitalism (Ukraine), *Order states* (Azerbaijan, Belarus), and *Remittance- and aid-based economies* (Moldova). [7]

The other papers can be divided into two main groups. The first one deals with an application of the mentioned approaches ([1], [2]), the second with a classification of institutional organization according to specific criteria. Within the first group, Farkas [8] compares old and new EU member countries on the basis of the individual dimensions set by [1]. The approach of [2] was used by [9] and [10], namely the division between *LMEc* (Bulgaria, Estonia, Latvia, Lithuania and Slovakia) and *CMEc* (Croatia, the Czech Republic, Romania and Slovenia). Within the second group, it is worth mentioning King and Szelenyi [11], who place an emphasis on the influence of political institutions (polity, bureaucracy) and after supplementing the other social-economic areas (social classes, foreign capital and income inequality), they identify three basic groups, *Capitalism from without* (Baltic States, the Visegrad Group), *Capitalism from above* (the Patrimonial system; Balkan, CIS) and *Capitalism from below* (China, Vietnam).

For the evaluation of the institutional diversity, the paper determines six proxies, which represent six dimensions of the modern capitalist economy, *Product markets*, *Labour market*, *the Financial System*, *Social Protection*, *Education* and *Political*

*environment*. The first five areas stem [2] (basic approach) and [8] (employed on the European transition countries). Unlike the above noted works, this paper adds the area of the political environment in the manner of [11] and [12]. The first three dimensions are represented by the individual pillars from the Global Competitiveness Report due to complexity (the first contains 16 indicators, the second and third 8 indicators). For proxy of social protection, the paper uses total government expenditure to GDP based on [2]. The quality of the educational system is evaluated using the Education index of UNDP, which is the arithmetic mean of the two indicators of the human capital, Mean Years of Schooling and Expected Years of Schooling. The last proxy represents the quality of the political (institutional) environment. The paper uses the concept of the Governance Matters of the World Bank, which is composed of the six parts (Voice and Accountability, Political Stability and Absence of Violence, Government Effectiveness, Regulatory Quality, Rule of Law and Control of Corruption). The last two selected proxies are ranked among the most used indicators in empirical literature.

Table 1. Proxies

Proxy	Unit	Source
Goods market efficiency	<1; 7>	[13]
Labour market efficiency	<1; 7>	
Financial market development	<1; 7>	
General government total expenditure	% GDP	[14]
Education Index	<0; 1>	[15]
Governance Matters (arithmetic mean of the six individual indicators)	<-2.5; 2.5 >	[16]

Source: author

Identification of the models of capitalism is performed using cluster analysis, specifically Ward's method. For identification, the paper uses comparative and graphical analysis. The selected proxies have a varied range; therefore, the paper uses a formula for the normalization of the index values to preserve the equal impact of all indices, in the manner of [17].

$$N_{i,t} = \frac{I_{i,t} - \text{MIN}(I_T)}{\text{MAX}(I_T) - \text{MIN}(I_T)} \quad (1)$$

Where  $I$  is the value of the index in time period  $t$ .  $\text{MAX}(I_T)$  ( $\text{MIN}(I_T)$ ) represents a maximal (minimal) value of the index during the whole time span  $T$ .  $N_{i,t}$  returns the value of each index within the range of 0-1.

One can consider 26 post-socialist countries of the Eurasian area (Albania, Armenia, Azerbaijan, Belarus, Bosnia and Herzegovina, Bulgaria, Croatia, the Czech Republic, Estonia, Georgia, Hungary, Kazakhstan, Kyrgyzstan, Latvia, Lithuania, Macedonia, Moldova, Montenegro, Poland, Romania, Russia, Serbia, Slovakia, Slovenia, Tajikistan and Ukraine). In the first part of the cluster analysis, the transition economies are compared with the advanced European states (Austria, Belgium, Cyprus, Denmark, Finland, France, Germany, Greece, Iceland, Ireland, Luxemburg, Malta, the Netherlands, Norway, Portugal, Spain, Sweden, Switzerland and the United Kingdom). The reference period is 2009 – 2014.

### 3. Results

According to the results of the dendrogram, one can divide the Eurasian area into three basic clusters; the first two groups are comprised of the countries of the European Economic Area and Montenegro (six sub-clusters in total) and the third contains the majority of the post-socialist states (four sub-clusters). To sum up, there are ten institutional diverse wholes in the Eurasian area, with the condition that each sub-cluster comprises at least three countries.

Figure 1. Clustering in the period of 2009 – 2014

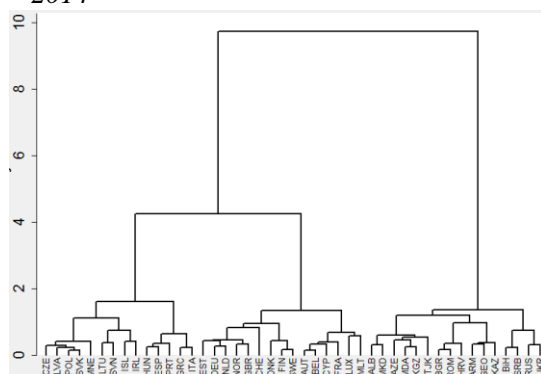

Source: [13], [14], [15], [16];

The first two clusters contain the most

successful post-socialist economies (EU-8 countries and Montenegro). Estonia can be considered the winner, as it is in the same group as continental economies (Germany, the Netherlands) or Nordic countries (Denmark, Finland, Sweden), whereas the other EU-8 states are at the level of the Mediterranean (Greece, Italy, Portugal, Spain). The third cluster includes a mixture of the remaining post-socialist economies. The following table summarises the individual sub-clusters, which are used for the subsequent analyses. The paper is aimed at transition economies, therefore omits the sub-clusters without a representative of the post-socialist countries (the fourth, fifth and sixth sub-group).

Table 2. The individual clusters

Cluster	Countries
1a	the Czech Republic, Hungary, Latvia, Lithuania, Montenegro, Poland, Slovakia, Slovenia
2a	Albania, Azerbaijan, Kyrgyzstan, Macedonia, Moldova, Tajikistan
2b	Bulgaria, Croatia, Romania
2c	Armenia, Georgia, Kazakhstan
2d	Bosnia and Herzegovina, Russia, Serbia, Ukraine

Source: author

First, the selected groups are compared based on the level of the individual dimensions of the modern capitalist economy; then, the influence of the recent global crisis is evaluated using several macroeconomics indicators (economic growth, foreign direct investment and economic performance).

The first graph shows a comparison of the sub-clusters according to the individual dimensions. Countries in the first groups (EU-8, Montenegro) reach the highest values (with some exceptions), above all in the area of education and political environment; on the other hand, there are weakness in the dimension of labour market. The labour market is more flexible in economies of sub-cluster "2c" (Armenia, Georgia and Kazakhstan), while rigidity is typical for the Balkan States (especially Croatia and Romania; cluster "2b"). For EU member states (cluster "1a" and "2a") there is a characteristically developed financial system and extended social protection in comparison with the others. Within the individual

dimensions, the largest differences are found in sub-cluster "2d", with, on the one hand, a relatively extensive public sector (relic of the former regime), and, on the other hand, rigid product market and underdeveloped financial system.

Figure 2. Individual dimensions and clusters

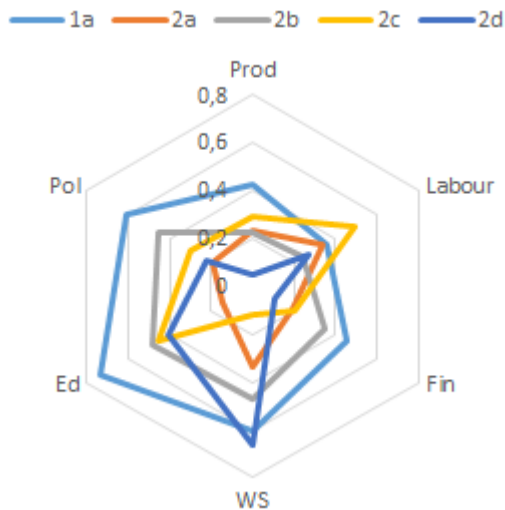

Source: [13], [14], [15], [16];

The influence of the recent global crisis is evaluated using three macroeconomic indicators, economic growth, inflows of FDI and size of unemployment, during 2006 - 2014. If one focuses on the development of economic growth (annual percentage growth rate of GDP per capita, constant 2005 prices \$), one can see a deep drop in all economies in 2009, particularly in the post-soviet area (Armenia, Georgia, Russia, Ukraine) and in the Baltic States (Estonia, Latvia, Lithuania); on the other hand, there are countries in sub-cluster "2a" (namely Albania, Kyrgyzstan, Tajikistan), which face relatively minimal consequences. The situation after 2009 shows that economies in the groups "2a" and "2c" are the most successful, meaning countries on the periphery, and in the last two years also EU-8 economies, the long-standing leaders. On the contrary, in the case of the group "2b", one can see more stagnation, and sub-cluster "2d" proceeds with recession as a consequence of the "War in Eastern Ukraine" (Russia, Ukraine) or inability to execute economic reforms (Bosnia and Herzegovina, Serbia).

Figure 3. Economic growth in 2006-2014

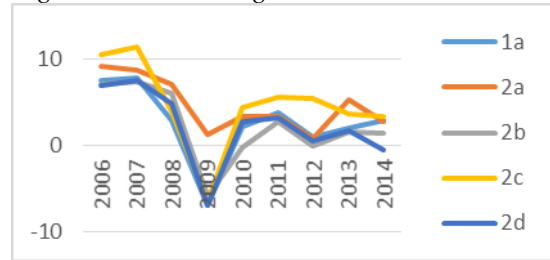

Source: [18];

Foreign direct investment (net inflows per capita, current \$, [19]) are the second indicator. Before the eruption of the recent global crisis, EU-8 countries and part of the Balkan States (sub-cluster "2b" and Montenegro) were the main focus of foreign investors in the Eurasian area, whereas after the crisis these economies were subject to the outflow of foreign investment (the highest in Bulgaria, Estonia, Lithuania, Montenegro and Slovakia) and up to now have not achieved their pre-crisis levels. Simultaneously, international investors direct FDI into the new economies, Albania, Azerbaijan and Kyrgyzstan.

Figure 4. Inflows of FDI in 2006-2014

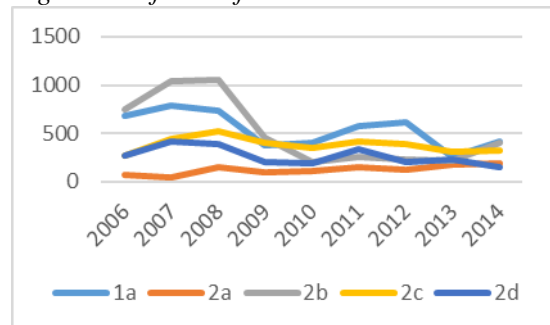

Source: [19];

The results of the third indicator, rate of unemployment of the total labour force (ILO estimate, [18]), show the individual clusters are closing in on each other. Whilst during the pre-crisis period there was considerable difference between the "1a" and "2b" clusters (on average about 10 %) and the others (in average cca 16 %), after 2009 the discrepancy was reduced, since within the first group the unemployment increased towards 13 %, whereas in the second sub-clusters the employment was decreased similarly towards 13 %. An exception can be seen in sub-cluster "2d" where there are big gaps: on one side Russia with 6 % unemployment, on the other Bosnia and Herzegovina and Serbia (unemployment over

22 %).

Figure 5. Unemployment in 2006-2014

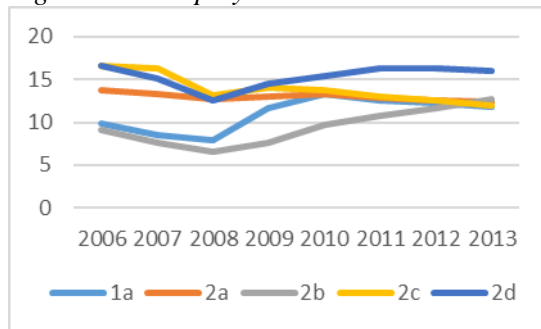

Source: [18];

#### 4. Conclusions

The European continent is still heterogeneous, particularly in institutional diversity. On the basis on Amable's approach to the models of capitalism, we executed a cluster analysis (Ward's method). We analysed the six dimensions of the modern capitalism (product and labour markets, financial system, social protection, education and the political environment) and identified three basic clusters and ten sub-clusters in the Eurasian area within the transition economies. According to the cluster analysis, only Estonia is on the same level as the EU core countries, whilst the other EU-8 countries and Montenegro are closer to the Mediterranean states. In comparison, CEECs and EU Balkan States have a higher quality institutional environment, but on the other hand, on the basis of analysis of the selected indicators, these economies were affected more by the recent global crisis than the mixture of the Balkan and post-soviet republics in the clusters "2a" and "2c" (namely Albania, Azerbaijan, Kazakhstan and Kyrgyzstan). The sub-cluster "2d" can be viewed as the group of losing economies. In the case of Russia and Ukraine, the influences of the recent global crisis are deepened by economic, political and military incidents after "Euromaidan", whereas Bosnia and Herzegovina and Serbia have long-reaching structural problems (e.g., high unemployment or relative low inflow of FDI). The paper is a basis for future research focused on the relationship between the models of capitalism, complementarity of institutions, the global crisis and the post-socialist area.

#### 5. Acknowledgements

This article was supported by IGA PEF MENDELU DP011/2015.

#### 6. References

- [1] Hall, P., Soskice, D. *Varieties of Capitalism: The Institutional Foundations of Comparative Advantage*. Oxford University Press, Oxford, 2001.
- [2] Amable, B. *The Diversity of Modern Capitalism*. Oxford University Press, Oxford, 2003.
- [3] Baumol, W.J., Litan R.E., Schramm, C.J. *Good Capitalism, Bad Capitalism, and the Economics of Growth and Prosperity*. Yale University Press, New Haven, 2007.
- [4] Becker, U. *The Changing Political Economies of Small West European Countries*. Amsterdam University Press, Amsterdam, 2011.
- [5] Esping-Andersen, G. *The Three Worlds of Welfare Capitalism*. Princeton University Press, Princeton, 1990.
- [6] Pryor, I.F. Market Economic Systems. *Journal of Comparative Economics*, 33(1), 2005, pp. 25-46.
- [7] Myant, M., Drahokoupil, J. *Transition Economies: Political Economy in Russia, Eastern Europe, and Central Asia*. Wiley-Blackwell, Hoboken, NJ, 2010.
- [8] Farkas, B. The Central and Eastern European Model of Capitalism. *Post-Communist Economies*, 23(1), 2011, pp. 15-34.
- [9] Knell, M., Srholec, M. Diverging Pathways in Central and Eastern Europe. In Lane, D., Myant, M. *Varieties of Capitalism in Post-Communist Countries*. Palgrave Macmillan, Basingstoke, 2007, pp. 40-62.
- [10] Schweickert, R., Ahlborn, M., Frank, K., et al. Large-Scale Transformation of Socio-Economic Institutions - Comparative Case Studies on CEECs. *WWWforEurope Working Paper, No. 16*, 2013.
- [11] King, L.P., Szelenyi, I. Post-Communist Economics Systems. In Smelser, N., Swedberg, R. *Handbook of Economic Sociology*. Princeton University Press, Princeton, 2005, pp. 206-232.
- [12] McMenamin, I. Varieties of Capitalist Democracy: What Difference Does East-Central Europe Make?. *Journal of Public Policy*, 21(3), 2004, pp. 259-274.
- [13] World Economic Forum. The Global Competitiveness Index Historical Dataset. <http://reports.weforum.org/global-competitiveness-report-2014-2015/>;
- [14] International Monetary Fund. World

- Economic Outlook Database.  
<https://www.imf.org/external/pubs/ft/weo/2015/02/weodata/index.aspx>;
- [15] United Nations Development Program. Education Index.  
<http://hdr.undp.org/en/content/education-index>;
- [16] World Bank Group. Worldwide Governance Indicators.  
<http://info.worldbank.org/governance/wgi/index.aspx#home>;
- [17] Rozmahel, P., Grochová, L.I., Litzman, M. The Competitiveness of the EU Countries: A Multi-dimensional Cluster Analysis Approach. In Huber, P., Nerudová, D., Rozmahel, P. *Competitiveness, Social Inclusion and Sustainability in a Diverse European Union*. Springer International Publishing AG, Cham, 2016, pp. 13-36.
- [18] World Bank Group. World Development Indicators.  
<http://databank.worldbank.org/data/reports.aspx?source=world-development-indicators>;
- [19] United Nations Conference on Trade and Development. World Investment Report.  
[http://unctad.org/en/Pages/DIAE/World%20Investment%20Report/World\\_Investment\\_Report.aspx](http://unctad.org/en/Pages/DIAE/World%20Investment%20Report/World_Investment_Report.aspx);



# The Impact of Economic Policies on Economic Growth in a Group of Arabic Countries: Empirical Verification using Non-Stationary Panel Model

Slim Mahfoudh

*Assistant Professor in the Higher Institute of Business Administration of Sfax (Tunisia) and a member of URED*

[Slim.mahfoudh@gmail.com](mailto:Slim.mahfoudh@gmail.com)

Mohamed Ben Amar

*Assistant Professor in the Faculty of Economics and Management of Sfax (Tunisia) and a member of URED*

[benamarmoha@gmail.com](mailto:benamarmoha@gmail.com)

## Abstract:

*The economic literature shows the existence of a real impact of the economic policies on economic growth. Since the 1980s, these policies in Arab countries have experienced significant reforms that sought to give them more flexibility and efficiency. This work proposes a study of the impact of monetary, fiscal and exchange rate policies on economic activity of a group of Arab countries in that to estimate a growth function on these countries using the non-stationary panel data model. From the results found, it was possible to identify the impact of the economic policies on economic activity.*

**Keywords:** monetary policy, fiscal policy, exchange rate policy, economic growth, non-stationary panel data model.

**Jel classification:** C23, E60, O40

## 1. Introduction

The question of the policy mix is now the subject of debate and discussion among economists and economic policy experts in the developed and developing countries. On the theoretical level, the problem of the policy mix, defined as the relationship between monetary policy and fiscal policy went through two different approaches, reflecting the conceptual changes that have affected the economic policies themselves. In a first approach, the policy mix is seen as a problem of optimal allocation of instruments

to goals, according to Fleming's article (1962), which are in relation to the main remarkable facts at that time, namely the opening of economies and capital mobility, recommends the allocation of monetary policy in the external balance and the allocation of fiscal policy to internal balance. Furthermore, the famous subsequent debate between monetarists and Keynesians concerning the adequate allocation results in underlying assumptions to the calculation of monetary and fiscal multipliers such the degree of openness of the economy, capital mobility, the nature of expectations and price flexibility. The second theoretical approach to the issue of the policy mix is studying the interaction between monetary and fiscal policies as a problem of coordination between the economic policy authorities. This new approach concerns strategic analysis of the policy mix, in relation to the independence of central banks and the European monetary unification. Our study will involve seven Arab countries namely; Algeria, Bahrain, Egypt, Jordan, Lebanon, Morocco and Tunisia; which do not present a problem of coordination between monetary and fiscal policies in the absence of central bank independence of these countries. That is why we will limit our research to the study of the first theoretical approach.

## 2. Literature review

In order to accurately describe the evolution of the interaction between monetary and fiscal policies in the economic literature, it is necessary to define the policy

mix and identify its characteristics through the various schools of thought starting from the classical school to the New Keynesian Economics.

For conventional, tight monetary policy is effective because of its immediate effect on the general price level. Indeed, the decrease in the money supply automatically leads to lower prices and therefore it is a purely disinflationary phenomenon. Therefore, the policy mix in favor of classical economists arises from a restrictive monetary policy and a passive fiscal policy.

For Keynesians, and according to the IS-LM model, fiscal policy is more effective than the interest rate is elastic with respect to the LM curve, and the higher the rate of interest is elastic over IS, monetary policy is more effective. A combination of both expansionary macroeconomic policies will allow us to have the optimal policy mix to simultaneously achieve the objectives of growth and price stability. Moreover, according to Mundell Fleming model that considered the opening of the economy, and a fixed exchange rate regime, in the absence of capital mobility, fiscal and monetary policies are ineffective, and, and such circumstances, the policy mix is determined by two passive monetary and fiscal policies. However, in case of perfect capital mobility, fiscal policy becomes effective while monetary policy remains ineffective, and therefore the appropriate policy mix will comprise a dominant fiscal policy and a passive accompanying monetary policy. But if the exchange rate regime is flexible, so in the absence of capital mobility, adequate policy mix consists of two expansionary monetary and fiscal policies and in case of perfect capital mobility, the policy mix consists of a dominant monetary policy and fiscal policy of passive support. Finally, from the interpretation of the Keynesian Phillips curve, it was obvious that the proposed policy mix should consist of expansionary fiscal and monetary policies to stimulate activity and achieve full employment, but at the expense of inflation.

For post-Keynesian, the policy mix consists of a dominant fiscal policy and a passive accompanying monetary policy. While for monetarists, and through the interpretation of the Phillips curve extended period, the policy mix should have a

combination of a dominant restrictive monetary policy and a passive fiscal policy.

Furthermore, and as regards to the new classical economists, we can say that they consider the absolute ineffectiveness of monetary policy is explained by the rational expectations that economic agents constantly form and therefore the policy mix in this School has passive monetary and fiscal policies.

Finally, for the New Keynesian, in case of fixed exchange rate and perfect capital mobility, the policy mix is defined as the combination of a dominant fiscal policy and a support monetary policy. However, in case of flexible exchange rate regime, and always in the presence of perfect capital mobility, the policy mix will be composed of a dominant monetary policy and fiscal policy of passive support.

The following table summarizes our analysis:

*Table 1: the policy mix across the different schools of thought*

<b>Theories</b>	<b>Policy mix</b>
<b>The classics</b>	Restrictive monetary policy + passive fiscal policy
<b>The Keynesians (Mundell &amp; Fleming)</b>	Expansionary fiscal policy + Expansionary monetary policy Ch. Fi, SM* : passive fiscal policy + passive monetary policy. Ch. Fi, PM** : dominant fiscal policy + passive monetary policy. Ch. Fl, SM*** : expansionist fiscal policy + expansionist monetary policy
<b>(Keynesian model + Philips equation)</b>	Ch. Fl, PM**** : dominant monetary policy + passive fiscal policy
<b>The post-Keynesians</b>	Expansionary fiscal policy + Expansionary monetary policy
<b>The monetarists (LT Philips curve)</b>	Dominant fiscal policy + Passive monetary policy
<b>The new classics</b>	
<b>The New Keynesians</b>	

	<p>Passive fiscal policy + Dominant and restrictive monetary policy</p> <p>Passive monetary policy + passive fiscal policy</p> <p>Ch. Fi, PM : Dominant fiscal policy + Passive monetary policy</p> <p>Ch. Fi, PM : Passive fiscal policy + Dominant monetary policy</p>
--	--

Beyond the theoretical side, Keynesian and monetarist theories have mostly fueled many empirical studies, particularly in the Federal Reserve Bank of St. Louis (Andersen and Jordan 1968; Keran, 1969 and Andersen and Carlson, 1970). In particular, Andersen and Carlson (1970) have developed and estimated a model, known as the St. Louis model, a name which expresses the change in the total current expenditure based on changes in the money supply and public spending. The objective of this model was first, to test the relative effectiveness of monetary and fiscal policies on economic activity, and secondly, to provide a forecasting tool of aggregate demand. The fundamental result that emerges is this method is that the impact of monetary policy is more important, faster and more predictable than that of fiscal policy.

In a later version of the St. Louis model, a specification in terms of growth rate was used (Carlson, 1978). Quarterly data with the United States over the period 1953-1978, the results show that the effects of public spending are close to zero while those in the money supply are significant.

Outside the United States, some authors, using mostly the St. Louis equation, reached mixed results: Keran (1970), Chowdhury (1988), Betten and Hafer (1983). The results of Keran (1970), about eight industrialized countries, have shown that the effects of fiscal policy were much more significant than those of monetary policy.

The study of Betten and Hafer (1983) for six industrialized countries (Germany, Canada, USA, France, Japan and the United Kingdom), concludes that monetary policy

had a significant effect in all the countries studied, while the budgetary influence was significant in France and the UK.

Chowdhury (1988) apply the equation St. Louis to six European countries: Austria, Belgium, Denmark, Netherlands, Norway and Sweden. The results indicate that the impact of monetary policy on economic activity was higher in three countries (Denmark, Norway and Sweden), while fiscal policy was more efficient in Belgium and Holland. The results for Austria have not been satisfactory.

Recently KomainJiranyakul (2007) used data from Thailand between 1993 and 2004, to arrive at the absence of a cointegration relationship between economic growth, public spending and the supply of money but at the existence of a unidirectional causal relationship between economic growth, public spending and supply of the currency.

Ciftcioglu and Begovic (2008) studied the relationship between economic growth and several macroeconomic indicators for a number of European countries between 1995 and 2003, and among their results, it gives off the negative effects of inflation and foreign debt on economic growth and the positive effects of domestic investment, economic openness and budget deficit on economic growth.

Finally, Ullah and Rauf (2013) analyzed the impact of certain macroeconomic variables on economic growth for a number of Asian countries for the period 1990 to 2010, they were able to identify that economic growth is positively affected by foreign direct investment and negatively by exports while the labor force and taxation have no impact on economic growth.

### 3. Presentation of the model and methodology of the estimate

In this section, we present the results and interpretations of our econometric analysis of the relationship between economic growth and economic policy.

#### Model presentation

Based on the model of Batten & Hafer (1983) increased student approaching Saint Louis as it was extended by several authors in recent years, the choice of this model is justified by the fact that it has been widely used by recent empirical studies on the

relationship between economic growth and economic policy.

The estimates that follow will be based on a function of the following reduced form:

$$GDP_{it} = \alpha + \beta_1 G_{it} + \beta_2 EXP_{it} + \beta_3 M2_{it} + \beta_4 INF_{it} + \beta_5 RER_{it} + \epsilon_{it}$$

with, i denotes countries (i = 1, 2, ..., N) and t represents time (t = 1, ..., T), GDP: the logarithm of GDP per capita calculated in constant 2005 dollars, G : the logarithm of the ratio of government consumption to GDP, EXP: the level of exports relative to GDP, M2: the logarithm of the monetary aggregate M2 as a percentage of GDP, INF: the rate of inflation, RER: the logarithm of the index of the real effective exchange rates,  $\epsilon_{it}$ : the error term and ( $\beta_1, \beta_2, \beta_3, \beta_4$  and  $\beta_5$ ) the vector of coefficients to estimate.

In what follows, we will try to advance this long-term relationship with panel data, taking into account the non-stationary series for a sample of 8 Arab countries for the period 1990-2013.

- We use GDP per capita as a variable determined for our sample.
- Exports account for changes in trade policy.
- Public spending measures fiscal policy.
- The monetary aggregate M2 shows the evolution of the money supply in circulation, it reflects the monetary policy.
- The inflation rate measures the degree of price stability which can influence the three previous policies.
- The index of the real effective exchange rate refers to the exchange rate policy.

### 3.1 Estimation methodology

A cointegration analysis on panel data provides a natural framework to examine the relationship between economic growth and its determinants.

#### Unit root tests

The study of the stationarity of all the variables is a necessary step in any study. In this study, we used the procedure of panel stationarity tests that are provided by Im& all (2003). These are the most used, when the time dimension is limited. The authors propose tests which allow the detection of the

presence of a unit root in models using ADF statistics File.

TABLE1: Unit root test results

Variables	GD P	G	EXP	M2	INF	RER
level	- 0.6 76	- 0.02 4	3.15 4	-0. 490	1.3 28	- 0.3 20
First differ ence	- 2.3 81*	- 3.15 4*	8.89 4*	- 7.236 *	- 8.372 *	- 8.484 *

\* = signification at 1 percent, \*\* = signification at 5 percentet \*\*\* signification at 10 percent.

Source: Author's calculation based IPS test results.

The IPS tests lead to the conclusion that all variables are not stationary in levels. The variables in the equation become stationary after first differentiating, so they are all integrated of order 1.

Having established that all series are integrated on the same order (1), we test the existence of a stable long-term linear relationship between these series.

#### Cointegration test

Once the integration in the first series order is verified, we can proceed to the cointegration tests. The application of the test Pedroni (2004) brings us to the following results:

TABLE2: Cointegration test results

	Statistics	Probabilities
Panel v-Statistic	6.323262	0.0000
Panel rho-Statistic	5.147879	1.0000
Panel PP-Statistic	-5.087215	0.0000
Panel ADF-Statistic	-5.316128	0.0000
Group rho-Statistic	6.391372	1.0000
Group PP-Statistic	-5.004103	0.0000
Group ADF-Statistic	-5.262592	0.0000

\* = signification at 1 percent, \*\* = signification at 5 percentet \*\*\* signification at 10 percent.

Source: Authors' calculations based on test results of Pedroni.

According to simulations of Pedroni

(1999), for small sample sizes, the most powerful of the seven test is similar to the ADF test (Group ADF-Statistic). The cointegration tests of Pedroni

(2004) presented in the table above show that there is a cointegration relationship between real GDP per capita and its determinants described by our theoretical model.

**Regression and interpretation**

The long-term relationship previously detected can be estimated using different methods, but false choose the most efficient. Pedroni (2004) concluded that the FMOLS estimator is most effective in estimating cointegration relations panel data.

*TABLE 3: Results of the regression method by FMOLS*

<b>Endogenous variable (GDP)</b>					
Variables	G	EXP	M2	INF	RER
	-0.116*	0.056*	0.152*	-0.111*	-0.084*

\* = signification at 1 percent, \*\* = signification at 5percent and \*\*\* signification at 10 percent.

Source: Authors' calculations based on the results of the regression method DOLS.

The negative sign given to public spending ratio is expected, since a large volume of non-productive expenditure reduces the growth rate for a given initial value of GDP, in other words, a significant handicap Directors growth, Barro (1990). The importance of the negative effect of government spending is about 11%.

The positive sign of the export coefficient is expected. For the policy of trade liberalization, literature indicates the existence of a possible positive causality between export growth and economic growth. A 1% increase in exports would increase 0056% of GDP per head.

Exports may be an acceleration engine for economic growth through various transmission channels to the real economy. The main channels are, firstly, a developed export sector improves the domestic and foreign investment, thus increasing capital accumulation. Moreover, the genesis of currencies, improves the balance of payments.

The results of our estimates show that each monetary policy based on the increase

of money in circulation in the economy measured by the monetary aggregate M2 (translate it appears near the phenomenon of money creation by the national financial system) improved economic growth in the countries in our sample. Each 1% increase in M2 would increase 0152% of GDP per head.

As shown Renelt& Levine (1992), the rise in inflation rates disadvantages economic development since it leads to an internal imbalance with a lack of investor confidence in government policies. This lack of confidence leads to reduced production, lower exports, the worsening of the trade balance and economic recession. In our study, the increase in inflation rates of 1% inhibits economic growth 0.111%.

Finally, we note that the appreciation of the real exchange rate adversely affects long-term economic growth. The negative and statistically significant sign of the coefficient of the TCR variable is consistent with the results predicted by the empirical work of Ghura&Grennes (1993) and Frankel & Rose (2002). By referring to our results, we can confirm the idea that undervaluation accelerates growth, whereas the overvaluation slows.

**Causality test**

In 1969, Granger led a causality test for time series then later in 2003 and for panel data. As the variables are I (1) and cointegrated, a model of error correction can be used to identify the causal direction.

*TABLE4: Causality test results*

Direction of causality	GDP	G	EXP	M2	INF	RER
→						
<b>GDP</b>	-	13.693*	42.712*	34.81*	82.44*	73.772*
<b>G</b>	0.137	-	23.017*	16.956*	6.714*	6.216*
<b>EXP</b>	8.520*	9.277*	-	97.085*	2.381***	19.335*
<b>M2</b>	2.452***	14.67*	2.679***	-	12.963*	25.32*
<b>INF</b>	37.033*	0.896	25.354*	31.431*	-	12.841*
<b>RER</b>	34.009*	10.1*	9.149*	16.092*	6.354*	-

\* = signification at 1 percent, \*\* = signification at 5percent and \*\*\* signification at 10 percent.

Source: Authors' calculations based on results of Grangers causality test .

The results in Table 4 show that there is a unidirectional causality of GDP to public spending to a level of significance of 1%. Ie an increase in GDP per head will cause an increase in government spending.

We also observe a bidirectional causality direction of other key variables GDP per

capita.

#### 4. Conclusion

Through our study, we tried; based on the model of Batten & Hafer (1983) increased student approaching Saint Louis as it was extended by several authors in recent years; to demonstrate the impact of economic policies on growth for a number of Arab countries between 1990 and 2013 using panel data. At the end of our research, we found that fiscal policy by increasing public spending has a negative effect on real activity and a commercial opening to increase exports, positively affects economic growth. We could also clear that a monetary policy aimed at increasing the money supply within the meaning of M2, could boost economic growth, although an increase in the inflation rate would have a negative impact on the economic activity. Finally, an exchange policy based on the slip of the real exchange rate aims to improve the competitiveness of local products on international markets and subsequently the progress of economic growth.

Finally, based on the Granger causality test, we showed a unidirectional causality of GDP to DPUB and a bidirectional relationship between GDP and four other determinants.

#### 5. References

- [1] Andersen, Leonall C., and Jerry L. Jordan. (1969): "Monetary and Fiscal Actions: A Test of Their Relative Importance in Economic Stabilization"; Federal Reserve Bank of St. Louis Review.
- [2] Andersen, C.L., Carlson, K.M., (1970): "A monetarist model for Economic stabilization"; Federal reserve Bank of St.-Louis review vol. 52.
- [3] Barro R. (1990): "Government Spending in a Sample Model of Endogenous Growth"; Journal of Political Economic vol. 98, n°5.
- [4] Betten, S.D., Hafer, R.W., (1983): "The relative impact of monetary and \_fiscalactions on economic activity :a cross country comparison", Federal reserve Bank of St.-Louis review vol. 65.
- [5] Carlson, K.M., (1978): Does the St.-Louis model now believe in fiscal policy ?"; Federal reserve Bank of St.-Louis review, vol.52.
- [6] Chowdhury, A.R. (1988). Expenditures and receipts in state and local government finances: Comment. Public Choice vol. 59.
- [7] Ciftcioglu and Begovic (2008): "The relationship between economic growth and selected macroeconomic indicators in a group of Central and East European countries: a panel data approach"; Problems and Perspectives in Management, Volume 6, Issue 3
- [8] Fleming Marcus J. (1962): "Domestic financial policies under floating exchange rates"; IMF Staff Papers, vol. 9, No. 3.
- [9] Frankel J. and Rose A. (2002): "An Estimate of the Effect of common Currencies on Trade and Income"; Quarterly Journal of Economics, Vol.117, n° 2.
- [10] Ghura, D. and T. Grennes (1993): "The Real Exchange Rate and Macroeconomic Performance in Sub-Saharan Africa"; Journal of Development Economics, Vol. 42.
- [11] Granger C. W. J. (1969): "Investigating Causal Relations by Econometric Models and Cross-spectral Methods"; Econometrica, vol. 37.
- [12] Granger C.W.J. (2003): "Some aspects of causal relationships"; Journal of Econometrics.
- [13] Hall R. E. and Jones C. I. (1999): "Why do some countries produce so much more output per worker than others?"; The Quarterly Journal of Economics, vol. 114, n° 1, February.
- [14] Im, K. S., Pesaran M. H., and Shin Y., (2003): "Testing for Unit Roots in Heterogeneous Panels"; Journal of Econometrics, Vol. 115.
- [15] Kao C. and Chiang M. H., (2000): "On the Estimation of a Cointegrated Regression in Panel Data"; Advances in Econometrics, Vol. 15.
- [16] Keran, M. W. (1969): "Monetary and Fiscal Influences on Economic Activity: The Historical Evidence"; Federal Reserve Bank of St. Louis Review.
- [17] Keran, M. W. (1970): "Monetary and Fiscal Influences on Economic Activity: The Foreign Experience"; Federal Reserve Bank of St. Louis Review.
- [18] Komain Jiranyakul (2007): "The relation between government expenditures and economic growth in Thailand"; National Institute of Development Administration, Thailand.
- [19] Levine R. and Renelt D. (1992): "A Sensitivity Analysis of Cross-Country Growth Regressions"; American Economic Review, vol.82.
- [20] Pedroni, P. (2004): "Asymptotic and Finite Sample Properties of Pooled Time Series Tests with an Application to the PPP

- Hypothesis"; *Econometric Theory*, vol. 20.
- [21] Pedroni, P. (1999): "Critical Values for Cointegration Tests in Heterogeneous Panels with Multiple Regressors"; *Oxford Bulletin of Economics and Statistics*, vol. 61.
- [22] Ullah and Rauf (2013): "Impacts of Macroeconomic variables on Economic Growth: A Panel Data Analysis of Selected Asian Countries", *GE-International Journal of Engineering Research*.

## Adequate Income – A (Pre)Condition for Economic Justice

Adina Moise – Titei

*Ovidius University, Constanta, Faculty of Economic Sciences*

[adinatitei@yahoo.com](mailto:adinatitei@yahoo.com)

Eleonora Baca

*Ovidius University, Constanta*

[eleonorabaca@yahoo.com](mailto:eleonorabaca@yahoo.com)

### Abstract

*In the present paper we focus on the assumption that adequate income is a condition for economic justice. Therefore, we analyse the income inequality and wealth distribution for 34 countries, EU or OECD member. We also make comparisons and we monitor the progress of these countries.*

*Our intention here is to highlight the role of the adequate income in increasing the welfare of individuals, groups and nations, in the national and international context.*

**Key words:** economic justice, adequate income, welfare, income inequality

**J.E.L. classification:** A13, E21, E25, O15

### 1. Introduction

The reduction of poverty and inequalities represents an idea discussed at almost all the meetings in which the world leaders took part in the last 50 years. Up to the mid-twentieth century, the main concerns for economic activity were limited to economic performance, as a unique measure for welfare. The recent history adds to the economic indicators a series of social indicators, aimed to emphasize some qualitative elements of life, such as aspirations or satisfactions. In this way the centre of gravity moves from quantitative to qualitative elements.

Presently, there is no consensus on „Which are the indicators for measuring economic justice?” or “Which are the economic and social conditions that can assure a high level of economic justice in a country?”. In this context, we choose to do an empirical analysis of the economic and social

elements which refer to adequate income as a condition for economic justice. Our aim is to highlight the interdependence between the new economic and social policies, on the one hand, and equity and fairness, on the other hand. Thereby, we focus on the arguments that sustain the assumption that adequate income is a condition for economic justice.

### 2. What does adequate income mean?

The recent data shows that the 80 persons richest in the world control almost half of the world's wealth. In this context, the excessive inequalities in income distribution represent one of the important problems that humanity faces, this delicate issue constitutes an obstacle against sustainable economic development and against building economic justice.

Therefore, we consider important to open a discussion on adequate income to assure economic justice. We take into consideration the idea that one of the problems we face today is the unequal access to resources for many of the countries participating in the global economy and the unequal access to resources for many of the individuals of a nation.

The words spoken by Christine Lagarde, at the last meeting of the Forum in Davos, Switzerland, come to support our statement. The President of the International Monetary Fund stated the following: "If you increase the income share of the poorest, you get a multiplying effect that you do not get if you increase the income share of the richest". She also argued that the income redistribution policies are not counterproductive for economic growth, this being an idea that slowly but surely was integrated into conventional thinking.



The Nobel Prize winner for Economics, Robert Shiller explains in his interventions the necessity to reform the economic system, "but not in a communist way". He states that it is a political issue and not just a matter of the economy's inability to more evenly distribute wealth. Unfortunately, the richest people use their resources to influence political decisions for their own benefit.

Many of the world's economies are currently under the pressure posed by globalization on the economic system; its impact on income inequality and poverty is greater as the initial resources are more limited. [2][3][5]

In his work "Human Capital: A Theoretical and Empirical Analysis, with Special Reference to Education", Gary Becker explains the income inequality in terms of cultural differences and disparate educational efforts and minimizes the role of biological differentiation, advocating for reducing these inequalities through investment in education. He debunks the myth that education has no visible and measurable benefits.[1]

By examining the relationship between income inequality and the general welfare in 23 of the richest countries in the world, Wilkinson and Pickett concluded that the social welfare is not influenced by income per capita. The main factor of influence is the income inequality. [4]

All these arguments support our choice of considering the income inequality as one of the indicators that allow us to measure the

degree to which a nation responds to requirements of economic justice.

Another indicator, the mean wealth per adult, completes the picture about ensuring adequate incomes as a condition for economic justice. As we all know, the distribution of power in a society often affects the opportunities of individuals to fully exercise their rights and live a dignified life.

### 3. The analysis of the two indicators considered

As we specified before, we include in the present study a number of 34 countries, EU or OECD member, countries with high or very high level of human development, most of these being considered the richest in the world.

To measure the income inequality we use the income quintile share ratio (also called the S80/S20 ratio). It is calculated as the ratio of total income received by the 20% of the population with the highest income (the top quintile) to that received by the 20% of the population with the lowest income (the bottom quintile).

The second indicator that we focus on is mean wealth per adult calculated in dollars at current prices and it measures the distribution among countries in the sample. Here, the net worth individual wealth is defined as the market value of financial assets plus non-financial assets such as housing or land, minus debts.

Figure 1 - Income inequality measured by S80 / S20 ratio

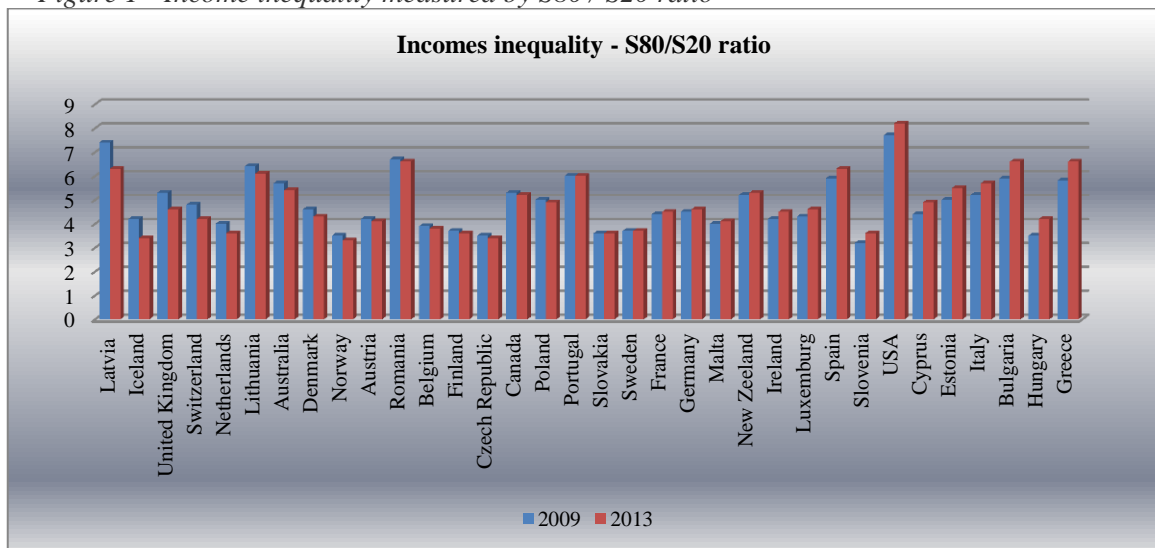

Source: For Australia, Canada, New Zealand and the USA we used the OECD source, for the other countries the source was Eurostat

For the year 2013, the highest levels of income inequality are in order in the USA, Greece, Bulgaria and Romania. For the USA, the incomes of the richest people are 8.2 times higher than the poorest. For Greece the level of inequality is 6.6, such as in Bulgaria or Romania. The country with the lowest income inequality is Norway, followed by Iceland and Czech Republic.

*Table 1 - Descriptive statistics for the series of data representing the values recorded for income inequality measured by the S80 / S20 ratio*

<i>Results for income inequality S80 / S20 ratio</i>	<i>2013</i>	<i>2009</i>
Mean	4,86	4,84
Standard Error	0,21	0,20
Median	4,60	4,55
Mode	3,60	4,20
Standard Deviation	1,20	1,14
Sample Variance	1,43	1,31
Kurtosis	0,15	0,06
Skewness	0,77	0,77
Range	4,90	4,50
Minimum	3,30	3,20
Maximum	8,20	7,70

Source: Data processing by author

At the sample level, for the year 2013 the average for the indicator S80/S20 is 4.86, by 0.02 percentage points higher than in 2009, when the value was 4.84. The number of

countries with lower values than the average was 19, in 2013, similar to 2009 (see Figure1).

For the 16 countries in the sample, the level of income inequality decreased 2013 compared to 2009, for three of these years the level remained the same, while for 15 countries the level of income inequality increased in this period, as you can see in Figure 1.

Regarding the wealth per adult in USD, in 2014, for our sample, we notice that the countries with the highest level of wealth were Switzerland and Australia. The lowest levels of wealth are in Bulgaria and Romania, under 20,000 USD per adult. Eleven of the countries in the sample had a level of wealth lower than 100 000 USD per adult in 2014, five countries register values between 100,000 and 200,000 USD per adult, other nine countries register between 200,000 and 300,000 USD per adult, and a sum over 300,000 USD per adult can be observed in other 9 countries, as you see in Figure 2.

The average level of wealth per adult was 195,817 USD for 2014 and 162,998 for 2009. It is obvious that the indicator registered a significant increase, even if the period under analysis is immediately following the 2008 economic crisis.

The wealth per adult has grown in nearly all countries in the sample; increases of over 100,000 USD per adult being recorded in Switzerland, Austria and USA.

*Figure 2 - Income inequality measured by wealth per adult in USD*

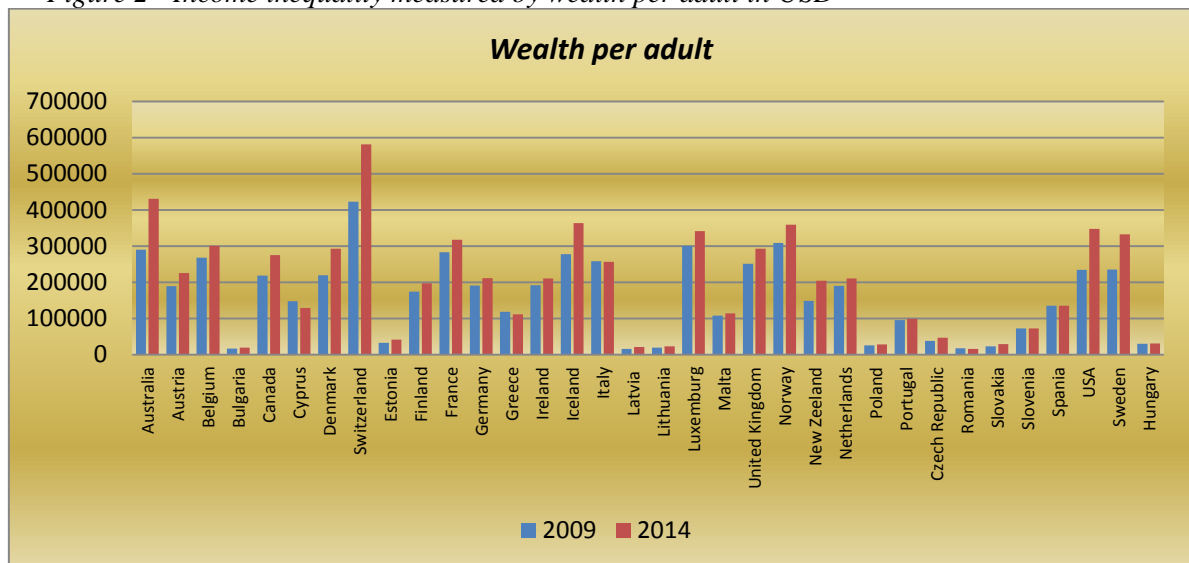

Source: Global Wealth Databook 2014 published by Credit Suisse Private Banking & Wealth Management Research Institute, Switzerland

*Table 2 - Descriptive statistics for the series of data representing the values recorded for average wealth level per adult*

<i>Results for wealth per adult</i>	<i>2014</i>	<i>2009</i>
Mean	195817,1	162998,06
Standard Error	24576,61	18673,51
Median	207188,5	181313,00
Standard Deviation	143305	108884,31
Kurtosis	-0,18	-0,75
Skewness	0,51	0,17
Range	565244	407634
Minimum	15442	15402
Maximum	580686	423036

Source: Data processed by author

#### 4. Conclusions

There is an increasing recognition that social policy can reduce inequality and poverty. As we observe in our study, there are a number of countries with positive signs in inequality reduction, countries for which the social system has been matured. Also, there are some countries in which the inequalities have widened as a result of the failure of social and economic policies.

The tax system and the government transfers have not always been able to mitigate the incomes inequality. Hence, we should be aware that the social transfer system is vulnerable. The budget cuts and the pressure of ageing population may also reduce the system efficiency.

Because in the last period the incomes for the richest segments of society in many developed countries have been in a significant increase, we support the idea that there was a greater concentration of income and wealth, which caused a new increase of

income inequality. Nevertheless, we must admit the fact that some inequalities are inevitable. In most of the above discussed cases, these reflect the level of productivity, the added value created, which is inherently unequal. The social policies can reduce these inequalities, but they can also lead to welfare losses in some situations.

Reducing income inequality will be possible if we better understand why our societies are becoming more unequal or which the consequences of income inequality are. We consider this direction a compulsory one, if we aspire for a just and more stable social structure.

#### 5. References

- [1] Becker, Gary S. *Human Capital: A Theoretical and Empirical Analysis, with Special Reference to Education*. 2d ed. New York: Columbia University Press for NBER, 1975.
- [2] Hesmati, A. 2010 – “The Relationship between Globalization, Economic Growth and Income Inequality”, *Journal of Globalization Studies*. Volume 1, Number 2 / November 2010
- [3] Verhoogen, E. 2008. – “Trade, quality upgrading and wage inequality in the Mexican manufacturing sector”, *Quarterly Journal of Economics*, Vol. 123, No. 2, p. 489–530;
- [4] Wilkinson, R.; Pickett, K. 2010 – *The Spirit Level or Why Greater Equality Makes Societies Stronger*, Bloomsbury Press, New York;
- [5] Williamson, J. 2002 - *Winners and losers over two centuries of globalization*, NBER Working Paper No. 9161 (Cambridge, MA, National Bureau of Economic Research);

## (Re)Mapping Geographies of Development- BRIC(S) Superpower Challengers?

Adina Moise – Titei

*Ovidius University, Constanta, Faculty of Economic Sciences*

[adinatitei@yahoo.com](mailto:adinatitei@yahoo.com)

Eleonora Baca

*Ovidius University, Constanta*

[eleonorabaca@yahoo.com](mailto:eleonorabaca@yahoo.com)

### Abstract

*The purpose of our present study is to investigate the concepts of power and superpower in their present day economic and political manifestation. Starting from Samuel Huntington's assumption, according to which, the current global system is a hybrid (uni-multipolar) system, in which the U.S. are a major power, we then take a close look at the way in which the BRIC(S) countries are attempting at present to challenge this dominating position.*

**Key words: power, superpower, BRIC(S)**

**J.E.L. classification: F59**

### Introduction

At the dawn of the twenty-first century, a number of economic analysts led by Goldman Sachs, observed the rapid growth of a number of market economies and labeled them, at first, as BRIC (without South Africa)-an acronym for Brazil, Russia, India and China. It was also estimated that these economies have serious prospects of continued relative growth and will have overtaken most of the current major world powers. The arguments used by Goldman Sachs included extrapolated figures predicting that China's economy would be the largest economy in the world, having overtaken that of the US, while India's economy was expected to be almost on a par with that of the US.[1]

Two years later, in 'Dreaming with BRICs: the Path to 2050', Dominic Wilson and Roopa Purushothaman, confirm and continue the above mentioned predictions by stating that within about half a century, the

BRICs would be the 'engine of new demand growth and spending power', which would offset the impact of graying populations and slower growth in the advanced economies[2]. The debate going on between academics and analysts about the future of the BRICs in the global power system was thus heightened and it remains a highly controversial topic even today.

### The Concept of Superpower

Significant academic interest is attracted by the debates on the possibility of BRICs to attain superpower status. It is obvious that these countries prospects appear promising, especially in terms of economic performance. This provided dominance in other forms of power, such as military, geo-political, social, cultural, but it does not grant a proportional influence on the global order and international relations. Especially because it is difficult to foresee whether they have real prospects of attaining the status of superpower individually or as a bloc. In order to explore this research question we consider useful the investigation of the concept of superpower as it is currently used.

Despite the fact that power is a central concept in International Relations academic discourse, a straightforward and uncontested definition of it is almost impossible to be provided. Power is seen in terms of relationships between or among actors (states), and as entailing the extent of influence exerted by one actor over the other- in this respect a major power or superpower is more influential relative to other(s).[3] Other analysts discuss power in terms of control of resources, in particular military resources- having strong military forces, means having the control of global

resources.[4] Nye describes 'hard' and 'soft' power and asserts that maintaining and maximizing soft power is fundamental to keeping the U.S. the worldwide leader. He asserts that China, Japan, India, Russia, and the European Union have the pre-conditions necessary to be superpowers.[4] In other scholars opinion power is determined by productive ability- meaning what a state is able to or deliver[5].

In Lyman Miller's opinion a superpower should be considered taking into consideration four axes of power political, military, economic and cultural

Power hierarchy has been designed according to political, economic, diplomatic and military influences of the states. On a descending scale the states are grouped in the following order, according to the amount of power exerted globally: superpowers, great powers/major powers and middle powers. In this framework, power is projected in a massive diplomatic, military, economic and political way. In 'The Lonely Superpower', Samuel Huntington considers the term superpower is inappropriate, and advances the term 'hyperpower' to refer to the US.[6] In his opinion the world is in a transitional stage, at the end of this transition the US becomes a major power. According to Huntington, the current global system is a hybrid (uni-multipolar) system, in which there is a single superpower on the one side, and many other major powers acting together, on the other side[6]. Huntington does not point to the BRICs group specifically, for the "other" side, but speculations can occur in this respect, considering its steady rise in global politics.

Considered individually or collectively, the BRICs present an important demographic advantage and not only... As of 2014, the five BRICS countries represent almost 3 billion people, or approximately 40% of the world population. The five nations have a combined nominal GDP of US\$16.039 trillion, equivalent to approximately 20% of the gross world product, and an estimated US\$4 trillion in combined foreign reserves. Considered individually- China has an estimated population of 1,393,783,836 as of July 1 2014, equivalent to 19.24% of the total world population. The median age in China is 35.7 years[7]. India's population is equivalent to 17.5% of the total world

population with a median age of 26.6. The two countries are the most populous countries in the world. Russia's population accounts for about 2.2 percent of the global population, while Brazil for 2.9 percent [7]. Geographically speaking the four countries under discussion are diverse and extensive. Inside the BRICs group, diversity is a common feature- they all enjoy diverse cultural, political and economic backgrounds. At present, analysts consider Brazil as the most promising and fastest-growing economy in its regional and international context:

Carl Meacham: In many ways what the BRICS countries share is their individual incomparability. Within its own regional or subregional context, each BRICS member clearly stands out. But unlike its fellow BRICS, Brazil is not an undisputed leader in its region—a region it shares with the United States. But it is the largest, most promising, and fastest-growing developing country in the Western Hemisphere, and that isn't to be taken lightly. In a region accustomed to U.S. leadership and dominance, Brazil is a rising star—and one that increasingly demands to be taken seriously on its own terms[8].

Inside the BRIC group, two countries tightened their trade and financial connections- Brazil and China. The diplomatic relations between China and Brazil begun in 1974 and strengthened in 2004. The inclusion of both countries in the BRIC group encouraged even stronger interaction.

Carl Meacham: China is, at this point, pivotal to the Brazilian economy—and it is this economic closeness that forms the lion's share of the Brazil-China relationship. China is, without a doubt, a strategic partner for Brazil in economic terms, though the two countries differ on many fundamental issues. But those issues aside, China is Brazil's largest trading partner. Trade flows have grown over tenfold since 2003, making the two the biggest partners within the BRICS. Brazil is among China's largest destinations for foreign direct investment, with Chinese cash fueling construction and development projects across Brazil. So, in short, Brazil's relationship with China—both within the BRICS and outside that framework—is fundamentally an economic one focused on the two countries' overlapping interests and growth trajectories [9].

2015 promises to be both an opportunistic and uncertain time. This year has begun more turbulent than expected- under the influence of the low oil price and of disruptive conflicts and changes at other various levels. In this context, analysts forecast unusual actions:

During periods like this, some countries will seek to shore up energy trade flows through the erection of new trade deals or by making infrastructure investments that tie countries together. Other countries and companies will start to question the costs and benefits of being tied to the international financial system and start to explore the feasibility and limitations of alternative systems and arrangements to underpin their energy investments. And nearly everyone, from private companies to state-owned enterprises and sovereign governments will reevaluate the political risk exposure in their portfolio and their approach to managing resource development [10].

According to statistics, Brazil slipped back into recession in 2014, and is expected to have seen zero growth as a result of weak commodity prices, low growth in major trading partners, drought, election uncertainty, and declining investment. Real GDP growth is expected to have a poor performance and to come in at just 0.5%. Inflation will remain high, private consumption subdued and unemployment will climb [11].

The Russian economy is confronted with various difficulties and, therefore, it is expected to shrink this year- due to Ukraine crisis and the weak petrol price. With 71% of exports based on mineral fuel in 2014, the Russian economy is over-reliant on the oil and gas sector. The effects of the oil price include a rising inflation, a weak currency and a collapse in business and consumer confidence. Investment level is in a continual decline, while the country is in a demographic difficulty, with a population growing slightly and aging rapidly.

The Indian economy enjoys a high business confidence, based on a real GDP growth forecast at 6.6%, one of the fastest growth rates of the country since 2011. The weak oil price is aiding the economy, as India's consumption is relying on imports. Nevertheless, structural reforms to the economy are expected in order to sustain the growth momentum [11].

The Chinese economic sector is continuing to adjust to slower growth, in 2014 its growth was at its slowest point since 1990. Its real GDP forecast for 2015 is at 7.1%. Inflation is decelerating, while the internal prices continue to fall. Industrial production is slowed down by weak domestic demand. The Chinese premier, Li Keqiang, alluded to a governmental effort to continue the implementation of policies which will place the economy on a sustainable growth path in his speech at the World Economic Forum in Davos, as a result analysts do not expect to see any large-scale stimulus in 2015 [12].

## Conclusions

In terms of their demographic realities, BRIC countries' large and varied domestic markets are expected to expand rapidly, as the growth of the middle class creates new consumers. A rapid increase in the demand for things such as automobiles, electricity and local capital markets is expected to occur. Compared to smaller emerging-market economies, the risks to investors should also be lower<sup>11</sup>. The main feature of the business and financial argument concerning the present and future economic significance of the BRICs countries, is based upon their economic size, and implicitly on the assumption that this involves economic dynamism.

A multipolar world is obviously beneficial and is expected to develop during the twenty-first century, by analysts, commentators and not only. This development is meant to neutralize the present hegemony of the world's unique superpower- the US. It has been largely speculated, and even hoped for, that this power shift will be performed by the BRICs countries. This assumption is partly supported by their rapidly developing economies, but it takes more than having an advanced economy to attain the superpower status. Other spheres of power need to be activated such as military force and increased diplomatic involvement in global affairs. A complete analysis, able to forecast the future can only be performed based on a careful consideration of the past, present and projected performance.

## References

- [1] Goldman Sachs, Building Better Global Economic BRICs, Global Economics Paper, 30 November 2001.
- [2] Dominic Wilson and Roopa Purushothaman, , Dreaming with BRICs: The Path to 2050', Goldman Sachs Global Economics Paper no. 99 (2003).
- [3] David A. Baldwin, , Power and International Relations', in Walter Carlsnaes, Thomas Risse and Beth A. Simmons (eds.), *Handbook of International Relations* (2002), pp. 177-91.
- [4] Joseph S. Nye, *The Paradox of American Power: Why the World's Only Superpower Can't Go Alone*, Oxford University Press (2002)
- [5] David A. Lake, , " Escape from the State of Nature: Authority and Hierarchy in World Politics", *International Security* 32;1 (2007), pp.47.
- [6] Samuel P. Huntington, , The Lonely Superpower', *Foreign Affairs* 78:2 (March April 1999)  
<http://www.foreignaffairs.com/articles/54797/samuel-p-huntington/the-lonely-superpower>
- [7] <http://www.worldometers.info/world-population/china-population/>
- [8] Kwang Ho Chun, *The BRICs Superpower Foreign and Security Policy Analysis*, Ashgate, 2013.
- [9] „Divergent Perspectives of the Democratic BRICS A Conversation with Carl Meacham, Jennifer G. Cooke, and Richard M. Rossow moderated by Amy Studdart”, at Global Forecats 2015,  
[http://csis.org/files/publication/141117\\_conversation\\_Studdart.pdf](http://csis.org/files/publication/141117_conversation_Studdart.pdf)
- [10] Sarah O. Ladislav, “Geopolitical Instability and Energy Markets”, in *Global Flashpoints 2015: Crisis and Opportunity*, Craig Cohen, Josiane Gabel (eds), Rowman & Littlefield, 2015 p.106
- [11] *Euromonitor International from IMF/OECD/National Statistics.*
- [12] Sarah Boumphrey, “ *Divergent Growth: The Economic Outlook for BRIC in 2015*”, at <http://blog.euromonitor.com/2015/02/divergent-growth-the-economic-outlook-for-bric-in-2015.html>

## Estimated Reaction Function of Fiscal Policy in Romania

Camelia Moraru

"Dimitrie Cantemir" Christian University, Constanta

[cami.moraru@yahoo.com](mailto:cami.moraru@yahoo.com)

Norina Popovici

„Ovidius” University, Faculty of Economic Sciences, Constanta

[norinapopovici@yahoo.com](mailto:norinapopovici@yahoo.com)

### Abstract

Romanian fiscal policy effectiveness can be assessed using fiscal policy reaction function, which follows the reaction of the structural budget balance to the recorded changes of indebtedness, output gap and to their previous values. In economic literature, the reaction function is the most relevant method of testing the sustainability of public finances. Estimated reaction function using Cyclically Adjusted Balance model showed that in the period analyzed in Romania as promoted a procyclical fiscal policy and in the decision process, the fiscal policy decision-makers do not take into account past performance of structural budget deficit indicator.

**Keywords:** fiscal policy, structural budget deficit, output gap.

**J.E.L. classification:** C32, E62, H60

### 1. Introduction

In general, a fiscal reaction function is a rule that governments use to forecast and to prepare to react against macroeconomic changes. Fiscal reaction function has become an increasingly important instrument for assessing fiscal policy.

Starting from the structural budget deficit we can estimate the fiscal policy reaction function, which tests the reaction of current or structural budget balance to the impulses manifested by the level of public debt, output gap and previous values of the current or structural budget balance [6].

This method, which examines the sustainability of public finances was proposed by Bohn in 1998 and used in 2005, enhanced by numerous other researchers

such as De Mello (2005), Gali and Perotti (2003), Fatas and Mihov (2002) [2,3]

Tax smoothing model developed by Barro in 1979 underlying fiscal policy sustainability analysis and presents the idea that the budget balance could be determined taking into account the leverage and a series of control variables that can influence the size of this indicator [1]. De Mello (2005) used to determine the reaction function values of previous periods for the following variables: budget balance, public debt, some qualitative variables meant to highlight changes in tax legislation. [4]

### 2. Data and research methodology

To estimate the reaction function, a tool for analyzing the sustainability of public finances, there can be used three models, but in this research we will use only the Cyclically Adjusted Balance model [7].

The Cyclically - Adjusted Balance model assumes that the size of the structural budget deficit can be explained by the initial position of public finances ( measured by the value of the structural budget deficit and public debt in the previous period) and cyclic conditions or situations (expressed by the value of the output gap). To estimate a fiscal policy reaction function we start from the following relationship (Gali and Perotti, 2003) [5]:

$$DBS_t = \alpha \times DBS_{t-1} + \beta \times DP_{t-1} + \gamma \times DePr_{t-1} + \varepsilon_t$$

where:

DBS = structural budget deficit;

DP = public debt, expressed as a percentage of gross domestic product;

DePr = output gap, expressed as a percentage;

$\alpha, \beta, \gamma$  = coefficients.



The structural deficit is a fundamental indicator of nominal convergence, illustrating how public finances are managed and which helps to get a clear image of an economy.

In other words, structural budget deficit is the permanent component of the budget deficit and reflects what would be the budget balance if a country's economy would follow the normal trajectory of growth (GDP equals its potential) and operates at full employment of labor, with rate unemployment between 5-6%, while inflation is stable.

Also, this indicator is used as a tool for discretionary changes conducted in fiscal policy, meaning evolutions due to fiscal policy promoted and not due to economic influences. The indicator can show how the changes in the fiscal position (transfers, taxes, charges) are justified by economic conditions and as a result of fiscal policy decisions promoted.

Regarding output gap, this tool indicates the cyclical position of a country. A negative "gap" indicates an underperforming economy while a positive "gap" indicates that an economy produces above its potential.

Structural budget deficit, the output gap and public debt are expressed as a percentage of GDP. Within the model the dependent variable is the structural budget balance and the explanatory variables include output gap considered a proxy for cyclical position and accumulated debt stock.

The analysis starts from 2000: 1 to 2013: 4, interval being chosen mainly because of data availability, but also because it presents some advantages. The outbreak of the global financial crisis is located near the middle of the range and there is a significant number of observations for each part of the event. The years 2000-2013 include the period during which a large part of the institutional framework has remained relatively stable in Europe, and European economies have not suffered other major shocks beside the crisis from 2008.

### 3. Results obtained

Long-term sustainability of fiscal policy is reflected by the negative value of the coefficient for the structural budget deficit reached in the previous period ( $\alpha$ ) and the positive value of the public debt ratio recorded in the previous period ( $\beta$ ) [9].

If the coefficient attached to the output gap,  $\gamma$  has a positive value, then the fiscal policy implemented was a counter-cyclical one and if the value is a negative one, then fiscal policy was a procyclical one [10].

Table 1. The regression results of the CAB model

Dependent Variable: DBS				
Method: Least Squares				
Variable	Coefficient	Std. Error	t-Statistic	Prob.
DBS(-1)	0,599467	0,108841	5,507716	0,0004
DP(-1)	0,103422	0,038641	2,676489	0,0254
OUTPUT GAP(-1)	-0,278772	0,115802	-2,407305	0,0394

R-squared	0,913451	Mean dependent var	-3,753846
Adjusted R-squared	0,904601	S.D. dependent var	2,561775
S.E. of regression	0,870245	Akaike info criterion	2,807575
Sum squared resid	6,815933	Schwarz criterion	2,981406
Log likelihood	-14,24924	Hannan-Quinn criter.	2,771845
F-statistic	31,66245	Durbin-Watson stat	2,395204
Prob(F-statistic)	0,000041		

Source: made by the author using EViews 7.1.

This model estimates the extent to which policy makers are considering the current cyclical conditions to draft public budget for the following year.

The results obtained by estimating fiscal policy reaction function for Romania using CAB model indicates that for the analyzed period, fiscal policy makers did not take into account the dynamics of previous structural budget deficit in the decision process (the coefficient was 0.59).

Looking at the debt coefficient (positive value, 0.10) we can say that the authorities pay some reduced attention to constraints on public debt. We can explain the reduced importance by the fact that the share of public debt to gross domestic product meet the criteria set by the Maastricht Treaty, namely public debt to GDP must not exceed 60% of GDP.

Also, in the period under review, fiscal policy was a pro-cyclical one as the output gap coefficient was negative and statistically significant for the 5% threshold. The recorded value of this ratio reinforces what we mentioned in our paper, respectively the mostly cyclical nature of fiscal policy in Romania [8].

#### 4. Conclusions

In our country the economic imbalance was reflected in the high value of the budget deficit and rising public debt. The substantial increase of public debt in recent years and the obvious difficulty of financing national deficits have led to reassessment of the degree of state intervention in the economy. It is also evident and already confirmed that a debt level above an acceptable threshold represents a vulnerability factor in achieving growth rates in the long term.

Using the same pattern it has been observed that fiscal policy has been predominantly expansionary in the range 2000-2002, 2004, 2006-2009. In these ranges structural budget deficit registered a significant increase, and to mitigate the values recorded by this indicator, and the current deficit values were necessary restrictive fiscal measures. Moreover, in 2006-2008 the output gap was positive indicating the importance of implementing a restrictive fiscal policy.

In Romania, tax reform must be linked with restructuring investments, the need for capitalization, with real convergence, with more flexible markets. Then, on the long term it is important that macroeconomic policies to pursue the realization of a general economic equilibrium, achieving sustainable economic growth in order to achieve real convergence, irrespective of modality of expression: gross domestic product per capita, proportion redistribution branches in economy regarding gross domestic product formation, reducing labor costs, changing the openness of the economy.

Romania is still trying to determine its place and role in the world economy, but also to identify those sectors and sub-branches of the national economy that could increase within global economy. This requires alignment with the EU requirements regarding the level of taxation along with

application of the other macroeconomic policies to improve the macroeconomic situation.

In Romania, the economic reality shows that the government is far from applying the appropriate economic policies. Basic characteristics of Romanian economy are the instability and unpredictability regarding reactions to changes in the budget. Fiscal interventions change over time, as scale and as tools used, depending on government policy objectives. The main measures are to mitigate the impact of the global crisis and to bring the Romanian economy to the point that will be sustainable. Fiscal instability leads primarily to discourage investment, and to remove them from other areas characterized by lower rates. Any increase in the flat tax, especially for income taxes, is considered a negative signal to investors and can lead to a liquidity crisis in business.

Currently the Romanian economy still shows negative determinations from its pre-revolutionary past and especially post-revolutionary one. I believe that to achieve a threshold of growth that allows raising the living standards of Romanian population requires a policy that specifically address three elements: encouraging domestic consumption, increased investment in production of goods and services and significant export growth.

In Romania, until now, current dynamics of macroeconomic indicators have shown that the government is far from applying adequate fiscal policies. The Romanian economy is in dire need of implementing a sustainable fiscal policy, which seeks to ban the waste of financial resources (this can be achieved by adopting a proper management of public expenditure), achieving macroeconomic balance and structural, but also the need to provide a general framework that encourages and allows growth. I believe that Romanian fiscal policy should have as main objective at present, economic growth and the consolidation of middle class.

It is preferred that the macroeconomic view of the Romanian economy to achieve sustainable growth, public debt within common sense, a low deficit level and most importantly, a prudent fiscal policy. I believe that when will be implemented measures dictated by those skilled in this area, when laws will be respected and when the public

interest will be the most important, economic growth will soon appear. But until then about economic growth we will write and talk a lot longer. Romania should re-evaluate fiscal policy in a way that includes, among its features transparency, accountability and clear operating mechanisms. Since procyclical fiscal policy reduces the effectiveness of automatic fiscal stabilizers, it is recommended to refrain from this type of policy.

## 5. References

- [1] Barro, R. (1979). On the Determination of the Public Debt, *Journal of Political Economy*, 87(6): 940-971;
- [2] Bohn, H. (1998). The Behavior of US Public Debt and Deficits, *The Quarterly Journal of Economics*, 113, 1-33;
- [3] Bohn, H. (2005), The Sustainability of Fiscal Policy in the United States, CESifo Working Paper, 1446, 1-30;
- [4] De Mello, L. (2005). Estimating a Fiscal Reaction Function: The Case of Debt Sustainability in Brazil, *OECD Economics Department Working Papers*, 423, 1-27;
- [5] Gali, J., Perotti, R. (2003). Fiscal Policy and Monetary Integration in Europe, *NBER Working Paper*, 9773, 1-43;
- [6] Giorno, C., Richardson P., Roseveare D., Noord van den P. (1995), Potential Output, Output Gaps and Structural Budget Balances, *OECD Economic Studies*, 24 (1), 167 – 209;
- [7] Dinu, Socol, A., Socol, C., Marinaş, C., (2012), Pro – Cyclical Fiscal Policies – Asymmetric Transmission Channel in Eurozone. The Romanian Case, *Revista Economic Computation and Economic Cybernetics Studies and Research*, 46 (1/2012), 85-101;
- [8] Nitu, O., Nitu, C.V., Condrea, E., Constandache, M., Duhnea, C., *Dynamics of Foreign Direct Investment Flows in Romania*, *International Journal of Management and Technology*, 1(1) : 111 – 124, 2011
- [9] Socol, A. (2009). *Macroeconomics European monetary integration. For Romania*, Economica Publishing, Bucharest;
- [10] Socol, A., Chiriacescu, B., (2008), The Estimation of the Structural Budgetary Deficit for Romania in the Context of Accession to the Euro Zone, *Theoretical and Applied Economics*, 3 (520), 13-28.

## Globalization and Next Level for Virtual Teams

Alexandru Moțățianu

*The Bucharest University of Economic Studies*

[alex.motz@gmail.com](mailto:alex.motz@gmail.com),

Oana Alexandra Vochin

*The Bucharest University of Economic Studies*

[oana.vochin@gmail.com](mailto:oana.vochin@gmail.com)

Lilian Chiachir

*The Bucharest University of Economic Studies*

[lilianchiachir@gmail.com](mailto:lilianchiachir@gmail.com)

### Abstract

*The technological advance has an important and increasing impact on today's society and economy market. Globalization and the continuous changing process, combined with competitiveness need of the organizations has as result virtual teams. This new concept is successfully applicable if its team members have a good collaboration in regards to the ongoing organizations' activities, but also for the project based activities.*

*Communication, common goals, soft skills and the power to work with colleagues that are geographically dispersed are some of the most important factors contributing to the success of the individuals, projects and organizational growth.*

*This paper presents elements of successful virtual teams and analyses the most important influenc factors of this process.*

**Key words:** globalization, virtual teams, strategic decisions, collaborative technologies.

**J.E.L. classification:** O31

### Introduction

In the present context, globalization became the principal direction of our days, generating important changes on traditional business environment [1], and information technology as one of the pillars of growth thereof has generated new strategic decisions, where the main actors are the virtual employees.

Thomas Friedman characterized

globalization as a democratisation of capital, technology and information in a way in which it begins to replace governments, as primary source for financing for the economic growth of companies and countries. [2]

Thus, in a globalized economy, all physical barriers disappear for capital, investments and strategic interests.

The organization is part of the economic, social, political, fiscal environment and all the changes from this ecosystem affect the smooth running of its projects. In this conditions, a close monitoring of external environment is necessary, respectively on the dependency factor which is coming from outside. The competition is the one having the highest influence on the power balance between organization and its external environment.

In this period, arose the concept of virtual teams, defined as a temporarily working group, with a high degree of cultural diversity, geographically dispersed and communicating using electronic means [3]. In the past, teams involved in a project the same space in the company's building, being physically collocated. Managers prefer this method of organization, because at that time it was impossible to control and resolve the strong dependences between team members and involved departments [4].

On today's market, the growing demand for coordination and integration, challenges all organizations to organize virtual employees who are linked via modern technology [5]. Even if they don't have interest in extending and developing their business to new markets or to become international, all companies have to comply with modern standards for staying

competitive on the market in this way [6].

Once with the IT evolution (high speed internet, broadband solutions, high-fidelity mobile communications etc.), the exponential increase in the number and quality of services offered, the alternative solution- the virtual team began to become increasingly widespread. Thus, we find today in different parts of the world teams working on the same project, the lack of this trend being an exception nowadays [7].

### **Virtual teams**

A virtual team is a group of talents, skills, procedures and working relationships between individuals in a group and has a hierarchical structure and a unified purpose. The most important factor for achieving successful virtual collaboration within the team is active participation and involvement, without which collaboration and learning cannot be achieved [8].

The teams involved in virtual collaborations are formed by individuals with comparable experience (engineers, economists, artists, testers etc).

The partnership and even the project itself will have a low or very low chance of success, if the members don't show coordination and partnership.

Therefore, from strategic position the company should support the creation coordination roles for people who will take a leadership role in this process. Individuals suitable for these positions have a multidisciplinary profile, very good communication skills and demonstrated leadership (soft skills). The quality of the leadership has an important influence on the team processes, motivation and outcomes [9].

These people will interact frequently with members of all teams, in order to facilitate exchange of information, to perform reviews and correct transmission of messages between the parties. They will be the ones to develop work processes during the design / development / testing of the project and will facilitate their smooth running.

Another important point that the organization has to achieve is to make the teams feel that they have a common goal. Specific instruments should be used to develop a shared understanding and commitment of the team members to achieve

the set target [10].

In this way, the virtual teams are working at the same project, have identical milestones, common budget consisting of the sum budgets which joint each involved team. Depending on the expertise of the people in the area/ field, there are taken decisions about the distribution of goals, task allocation etc.

### **Challenges met**

In the competitive global environment met today, a virtual team that works completely remotely is associated with maximum flexibility and lowest operational expenditure, since it cuts down the administrative costs, travels, plus it adds increased responsiveness and resources utilization [11].

But next to these advantages, this setup comes by default with several potential issues and barriers to be over passed or assumed.

A common topic here is the lack of structure and authority on the project team. People are allocated frequently on several different developments and have distinct objectives and interests for each of them. More they belong to different hierarchies, and in most cases their direct manager is involved in other areas, or projects.

This can generate delays, frustration and in this conditions the email applications become naturally the most extensively used tools, the quantity of messages simply flooding the team, with no real value added. Many times, this is the direct, root-cause for communication jams, cascading to escalations, more emails, meetings and calls, lots of wasted time for everybody involved.

A direct subordination hierarchy can simplify the stream, allowing the Project Manager or Team Lead, to control the progress, problems met, people performance and their level of motivation.

One of the main characteristics defining a virtual team relies on the physical distance between the team members. This comes with the corresponding time difference associated, and as it increases, the synchronous collaboration becomes more and more difficult.

For example: a team having members in Bucharest, but also on the East Coast of United States, means around 7 hours difference. In this context, the teams will

overlap as working time for only one or two hours, daily. They need to do extra efforts to come earlier, or to work later in order to maximize this interval, to facilitate the meetings and calls, and synchronous collaboration.

There are compromises to be done, regarding planning presence on meetings and working hours, that reinforce the difficulty in managing time zones difference.

Coordinating distributed teams is one of the most challenging objectives to be completed. The team needs to be correctly informed about its objectives, progress and to be able to participate in the decision making process.

From here, the communication policy is another frequent point mentioned as a failure factor when working with virtual teams, and most of the studies consider it as critical for a remote project success.

### **Next level for virtual teams**

Two main directions are recommended for succeeding with virtual teams.

First is related to the general framework allowing remote collaboration, based on the access to latest generation IT tools and applications, allowing a good level of interaction between team members during the project.

Secondly regards the core elements of collaboration and probably the most important one, that creates a bridge over the cultural differences and geographical distances.

Communication was and it always will be a key element either for classic or virtual projects. More, since working remotely effective communication is highly desired in a virtual team and heavily dependent on the communication tool [12], since is the only mean able to shrink distance between players.

The way team members interact, the trust built between them, seen as a vital component of a virtual team, clear and transparent objectives, roles and responsibilities, plus allocating extra time to make sure they are correctly understood, all represents key success factors for building a strong collaboration despite physical distance and cultural differences between partners.

It is well known, that these cultural

differences combined with language gaps might transform a written communication into a complicated and time consuming instrument, similar to sending and receiving simple instructions.

People in front of the email, or chat page became easily more aggressive in expressing their points, compared with a face to face conversation, even remotely, through webcams Visual contact is really important, since communication implies lots of non-verbal messages that are lost without using this channel. Studies show that 60 to 90% of the overall communication is non-verbal, and this is completely lost when writing [13].

In the same time, associating a name, a voice and an image become really helpful in interacting with business partners, team around the globe.

Even if working remotely implies distance, one of the recommended practices met is dedicated to methods for bringing people closely, together, and in this sense, face to face meetings through modern communication tools are crucial for project success, since every team member need to know the person behind his/her collaborator [14].

Social component, also known as social capital [15] is really important for succeeding in this context, since the social network may enhance the effectiveness of the team while apparently the remote work makes it disappear.

For example, team casual meetings are extremely limited since they cannot physically met on coffee break, plus coffee might sound reasonable for someone in Montreal at 9 AM in the morning, still in Bucharest for his/her peer is already 4 PM in the evening.

Presently, social networks helps a lot on this component, people being able to know each other better from blogs, likes and don't likes. They allow the team to get extra topics to discuss, and create a stronger communication frame between people.

Large companies developed in house social networks, in order to facilitate this need, since they understood this media as a tool for virtual team communication [16], keeping the space private, for internal use.

Other than these, the company can facilitate social interaction, to enhance team spirit creating similar events for the remote

locations, like "pancakes day", or organizing video games tournaments, allowing people can join online from their location.

Meetings related to the project life for sharing the updates to entire crew, can be held remotely from the conference room, using high-tech video tools and applications.

More, yearly meetings can be held, bringing everybody together, still this requires extra efforts from financial and logistic point of view.

Team development practice is by far the investment needed for any company to assure sustainable business.

On one hand, during our days there are plenty of internet resources focused on online training, webinars, trainings dedicated to develop expertise remote. People can join and participate on these sessions using the same communication IT infrastructure, pass exams or get certifications on their specific field of interest.

On the other hand companies organize their own remote sessions, but also their own knowledge database, using local SMEs expertise, in a continuous learning process.

These experts keep life or recorded presentation in front of the virtual team, on specific items, processes, procedures, or new technologies, facilitating the development of the team, supporting this way company strategic business decision.

Some of the most dynamic and fast growing companies on the IT industry, pushed the virtual team philosophy to new levels.

Their business model relies on fully virtual teams, distributed around the world, strongly supported by measurement tools. This allows them to monitor individual activity and performance based on specific indicators, being in essence an anti-fraud measure that solves part of the present challenges virtual teams are facing these days, and mentioned above.

The measurement tools include software solution that track mouse, keyboard activity, website visited, takes random photos through webcam, and record the effective time spent at work. This way their projects have a correct structure and proper authority levels.

Having distributed office around the world, they are able to access through mixed rates offered, top specialists globally, keeping in the same time flexibility since

their working model is project based.

Recruiting is another key for their success, automated process through their online platform, being combined with several hands-on tests, but also with phone interviews.

Evaluation after delivering a project, or personal objectives inside a project, is another important part of the puzzle, since based only on the performance and recommendations received, the candidates will have increased chances to be staffed for the next projects.

### **Pro and cons**

There are several reasons organizations worldwide should adopt this new model, and these are mostly driven by their present needs.

This way HR departments will be able to recruit only top performers, no matter if they are located near company premises, from other university-centre cities, or anywhere else, and they won't worry anymore about relocating or face an "over offered" market.

The physical link between company and employee, will simply disappear. Going forward the cost/value ratio when recruiting for specific position will go down, since the associated cost decreases going from industrialized areas, university-centres, inside highly developed countries, to remote locations, placed in under-development regions.

Working fully remotely can reshape the employment as we now it not, having the roots in project based philosophy.

Companies will contract services on a flexible manner, and they will pay fixed prices, also known as cost, to each human resource involved in a project. This way, taxes will decrease but also the pressure to allocate efficiently their employed resources goes down, being driven only by the need to create more and competitive business.

Studies [17] proved that 20-25% of daily working hours are lost in other activities, so the model proposed, having people involved 100% in projects, will significantly increase the overall efficiency of the company, either by growing the projects portfolio with the same effort, meaning extra revenue, either by saving costs, keeping the top performers, being able to pay them more competitively

etc.

Based on a research made in China, it seems that productivity is higher for people working from home, compared with the ones going to the office. More it seems the overall satisfaction was higher, and the retention rate also [18].

Another major incentive to follow this business model is related to administrative costs. Having resources located around the globe, office space required, including here all the necessary facilities goes down, impacting also the carbon footprint generated. This might generate profit for the company, or extra money to invest in innovation, research and development, the means able to push it forward while facing the competition.

Last but not least the system will make a clear segregation in terms of people performance, separating the performers from non-performers, creating a highly competitive environment, where even the last ones will make efforts to align, specialize and to provide more value added than before.

From the employee point of view there are a couple of "pros" to be mentioned.

Working from home, or anywhere else is one of them. In average [19] people spend around 1-2 hours daily in their way to work. This business model will allow them to get back traffic hours, that are mostly lost and transform them in productive time for business, or relaxation time for what matters most for each individual.

Flexible working hours will reinforce again the work-life time balance, allowing to the subject to prioritize and solve main issues in a more efficient manner.

Being highly paid, the individual will be able to set his own priorities, take longer vacations, or work harder to meet his personal objectives.

As potential drawbacks people feeling tracked is one of the major inconvenient. They might become frustrated that don't receive enough trust and this might impact their overall activity, potentially generating attrition.

Social interaction can be another weak point, still the time got back from traffic, might compensate it, people being able to spend extra few hours daily on things that really matters for them.

Another thing that might come up with

this model is the places where you don't want to be. Strict rules and staffing model will prevent reaching the situation when employees are visiting sites or having interactions beyond law, common values or morality.

## Conclusions

Virtual teams are the success key for many organizations in order to improve their efficiency and productivity by breaking all time, space and even organizational barriers.

Even if the whole process is depending on the constant advancements in technology, IT evolution cannot guarantee its success, but the ability of the team members to communicate, share information, trust each other [20] in conjunction with their skills, team spirit and leadership can.

## References

- [1] Baker G., "The Effects of Synchronous Collaborative Technologies on Decision Making: A Study of Virtual Teams", *Information Resources Management Journal*, Ica Group Publishing, USA, Oct.- Dec. 2002, pp. 79-93.
- [2] Friedman T. L. *The Lexus and the Olive Tree*, Anchor Books, Canada, 2000
- [3] Bonet Bonet D., France F., Jawadi N., "Virtual R&D Project Teams: From E-Leadership To Performance", *Journal of Business & Economics Research*, Volume 31, number 5, September/ October 2015
- [4] Silas T. S., Osho S. G., Nealy C., "The Impact Of Human Interaction On The Development Of Virtual Teams", *Journal of Business & Economics Research*, Volume 2, number 12, December 2004
- [5] Parker B., *Introduction to Globalization and Business Relationships and Responsibilities*, SAGE Publications, London, U.K., 2005, pp. 182- 221
- [6] Hebbel- Seeger A., Reiners T., Schäffer D., *Synthetic Worlds Emerging Technologies in Education and Economics*, Springer, Hamburg, Germany, 2014, pp. 103- 113
- [7] Ghilic-Micu B., Stoica M., *Echipa virtuala – forma de munca colaborativa in economia de retea*, Revista Informatica Economica n0.3(27), Bucharest, 2003
- [8] Ebrahim, A., Shamsuddin, A. & Taha, Z., "Virtual Teams: A Literature Review", *Australian Journal of Basic and Applied Science*, 2009, pp. 2653- 2669.
- [9] Hebbel- Seeger A., Reiners T., Schäffer D.,



- Synthetic Worlds Emerging Technologies in Education and Economics*, Springer, Hamburg, Germany, 2014, pp. 80-93
- [10] Betsy C., "Leading to Increase Commitment in Virtual World Collaboration", 2008, available at <http://www.leadingvirtually.com/leading-to-increase-commitment-in-virtual-world-collaboration/> [accessed at 03.11.2015]
- [11] Liu C., Liu H., "Increasing competitiveness of a firm and supply chain with web 2.0 initiatives", *International Journal of Electronic Business Management*, Vol. 7, No. 4, 2009, pp. 248-255
- [12] Gupta H., Wingreen C.S., "Understanding the Effect of Social Media Tools on Organisational Virtual Team Dynamics", University of Canterbury, New Zealand, 25th Australasian Conference on Information Systems, 10.12.2014, pp. 1-10
- [13] Harrigan J. A., Rosenthal R., Scherer K.R., *The new handbook of Methods in Nonverbal Behavior Research*, Oxford University Press, USA, 2008, pp. 339- 345
- [14] Dumitrescu D., *Incredere si capital social in organizatia virtuala multiculturala*, Doctoral Thesis, SNSPA Bucharest, 2012
- [15] Katz N., Lazer D., "Building effective intra-organizational networks: The role of teams", DSpace@MIT, Harvard University Cambridge, MA 02138, 2003, pp. 9 - 14
- [16] Gupta H., Wingreen C.S., "Understanding the Effect of Social Media Tools on Organisational Virtual Team Dynamics", University of Canterbury, New Zealand, 25th Australasian Conference on Information Systems, 10.12.2014, pp. 1-10
- [17] Pardey D., *Planning to Work Efficiently*, Elsevier Ltd. , UK, 2007.
- [18] Bloom N., Liang J., Roberts J., Ying Z. J., "Does working from home work? Evidence from a Chinese experiment", *Quarterly Journal of Economics*, Stanford University, Stanford, California, 03.03.2015, pp. 166-172
- [19] Johnson T. & Spizman F. R., *Will Work from Home. Earn the Cash Without the Commute*, Penguin Group, USA, 2008.
- [20] Bostan M., *Managementul riscului – fundamentul unei dezvoltări durabile într-o nouă societate bazată pe cunoaștere*, Research project inside Postdoctoral Economic Studies Academy, Bucharest, 2012

# The Knowledge Assessment Methodology of Countries

Dorinela Nancu  
„Ovidius” University of Constanta  
[cusudorinela@yahoo.com](mailto:cusudorinela@yahoo.com)

## Abstract

*Currently, the main resource of global economic development is represented by knowledge. Economies can experience progress in relatively short periods, to the extent that they are able to create, access, use and disseminate knowledge.*

**Key words:** the knowledge assessment methodology, the knowledge index (KI), the knowledge economic index (KEI)  
**J.E.L. classification :** D 80, D83

## 1. Introduction

In order to analyze a country's ability to compete in a knowledge-based economy, the World Bank established the Knowledge Assessment Methodology (KAM), by the Knowledge for Development Program (K4D). This methodology is based on 148 structural and qualitative variables and a group of 146 countries, which includes most OECD economies (Organization for Economic Co-operation and Development) and over 90 developing countries. These variables support the four pillars of knowledge based economy:

- a stimulating institutional and economic environment that enables the free flow of new or existing knowledge;
- an educated and skilled population in order to create, share and use knowledge.
- a network of private enterprises, research centers, universities, etc. in order to adapt to local needs, and create new technologies.
- a dynamic information infrastructure – ranging from radio to the internet – in order to facilitate the effective communication, dissemination and processing of information.

## 2. The Knowledge Index (KI)

**The Knowledge Index (KI)** is an interactive tool used in order to compare a country's position to other countries, in the shift to a knowledge-based economy. It is a tool created by the World Bank in order to measure a country's ability to generate, adopt and disseminate knowledge. From a methodological standpoint, KI is the arithmetic average of the performance score obtained by a country or a region based on three pillars:

- **education and human resources index** - represented by the arithmetic mean of the scores on three key variables: average years of schooling, secondary enrollment and tertiary enrollment;
- **innovation index** - represented by the arithmetic mean of the scores on three key variables: Royalty Payments and Receipts, patents issued by the US Patent Court and the scientific and technical journal articles;
- **information and communication technology index (ICT)** - represented by the arithmetic mean of the scores on three key variables: the use of telephones, computers and the Internet among 1,000 people.

## 3. The Knowledge Economic Index (KEI)

**The Knowledge Economic Index (KEI)** measures the general level of development of a country or region, emphasizing that the environment of the respective country or region is favorable to the use of knowledge for economic development. From the methodological standpoint, KEI is the arithmetic average of the performance score obtained by a country or region based on four pillars:

- **Economic Incentive and Institutional Regime Index**- represented by the arithmetic mean of the scores from three key variables: tariff and non-tariff barriers, regulatory

quality and the rule of law of a country or region;

□ **Education and human resources Index** - represented by the arithmetic mean of the scores from three key variables: average years of schooling, secondary enrollment and tertiary enrollment;

□ **Innovation Index** - represented by the arithmetic mean of the scores on three key variables: total Royalty Payments and Receipts, patents issued by the US Patent Court and the scientific and technical journal articles;

□ **Information and Communications Technologies (ICT) Index** - represented by the arithmetic mean of the scores on three key variables: the use of telephones, computers and the Internet among 1,000 people.

**Table no. 3.5 – The Knowledge Index and the Knowledge Economy Index (KI and KEI)**

Country	KEI	KI	Economic Incentive	Innovation	Education	ICT
Sweden	9.43	9.38	9.58	9.74	8.92	9.49
Finland	9.33	9.22	9.65	9.66	8.77	9.22
Danmark	9.16	9.00	9.63	9.49	8.63	8.88
Netherlands	9.11	9.22	8.79	9.46	8.75	9.45
Norway	9.11	8.99	9.47	9.01	9.43	8.53
Germany	8.90	8.83	9.10	9.11	8.20	9.17
Switzerland	8.87	8.65	9.54	9.86	6.90	9.20
Ireland	8.86	8.73	9.26	9.11	8.87	8.21
Great Britain	8.76	8.61	9.20	9.12	7.27	9.45
Belgium	8.71	8.68	8.79	9.06	8.57	8.42
Island	8.62	8.54	8.86	8.00	8.91	8.72
Austria	8.61	8.39	9.26	8.87	7.33	8.97
Estonia	8.40	8.26	8.81	7.75	8.60	8.44
Luxemburg	8.37	8.01	9.45	8.94	5.61	9.47
Spain	8.35	8.26	8.63	8.23	8.82	7.73
France	8.21	8.36	7.76	8.66	8.26	8.16
Czech Republic	8.14	8.00	8.53	7.90	8.15	7.96
Hungary	8.02	7.93	8.28	8.15	8.42	7.23
Slovenia	8.01	7.91	8.31	8.50	7.42	7.80
Italy	7.89	7.94	7.76	8.01	7.58	8.21
Lithuania	7.80	7.68	8.15	6.82	8.64	7.59
Slovakia	7.64	7.46	8.17	7.30	7.42	7.68
Portugal	7.61	7.34	8.42	7.62	6.99	7.41
Cyprus	7.56	7.50	7.71	7.71	7.23	7.57
Greece	7.51	7.74	6.80	7.83	8.96	6.43
Latvia	7.41	7.15	8.21	6.56	7.73	7.16
Poland	7.41	7.20	8.01	7.16	7.76	6.70

Croatia	7.29	7.27	7.35	7.66	6.15	8.00
Romania	6.82	6.63	7.39	6.14	7.55	6.19
Bulgaria	6.80	6.61	7.35	6.94	6.25	6.66
Serbia	6.02	6.61	4.23	6.47	5.98	7.39
Russia	5.78	6.96	2.23	6.93	6.79	7.16

Source: <http://info.worldbank.org/> [5]

By analyzing the **Knowledge Economy Index (KEI)** as shown in the above table, it is revealed that the top five countries benefitting from an economic environment favorable to the use of knowledge for economic development are Sweden, Finland, Denmark, the Netherlands and Norway, which got a KEI score over 9. For the above-mentioned countries, the KEI index calculation reveals that the lowest rate is held by the education pillar, except for Norway. In other words, the education system lowers the KEI level for these countries. The score obtained on innovation highlights, for the countries analyzed, the fact that the environment is conducive to innovation, harnessing knowledge for economic development.

**Romania** is situated in the second part of the classification, ahead of Bulgaria, Serbia and Russia. **Romania's KEI is 6.82.**

Romania's KEI is pulled down by the innovation index and by the ICT index. In other words, our country is poor in terms of total Royalty Payments and Receipts, patents and scientific and technical journal articles and the use of telephones, computers and the Internet among Romanians is still low, compared to other European countries.

Eurostat statistics show that, in 2012, in Romania, 8% of the population aged 16-74 years had high skills in computer use and only 5% of the analyzed segment had high skills in using the Internet. [1]

Romania's KEI is raised by the education system, with a score of 7.55, and by the economic regime, with a score of 7.39.

The conclusion that can be drawn from these figures is that Romania needs improvement across all four pillars (economic regime, education, innovation and ICT), in order to become an environment which harnesses knowledge for economic development.

#### 4. Issues regarding the relevance of knowledge based economy for Romania

The knowledge based economy is often presented as being based on advanced science and technology, on leading industries and high technology sectors, fields where Romania is still lagging behind. Current priorities focus mainly on overcoming the economic crisis, providing jobs, the survival of companies and achieving a high volume of marketable production, allowing a minimum profit. [2]

*"Romania's economy is in the early stages of development. Questions were sometimes asked about the need to promote the knowledge based economy [...]. Policy makers wonder whether Romania should be concerned about the concept of Knowledge Economy as long as it does not even have a DEVELOPPED industrial economy (almost half of the population is located in rural areas). Knowledge Economy has often been presented as being based on advanced science and technology, on leading industries and high technology. On the other hand, Romania is still lagging behind in these areas. Current priorities focus mainly on providing jobs, on the survival of companies and on achieving a volume of marketable production in order to allow a minimum profit. For some conservative specialists, it seems pointless that Romanian managers worry about the knowledge based economy. They believe that it would be better for Romania to focus on high-consuming workforce industries". [3]*

In the knowledge based economy, prosperity is conditional on the nation's ability to create and harness scientific and technological knowledge. Its implementation requires a scientific basis and a well-developed information infrastructure. This is difficult especially for the relatively small economies, such as Romania's economy. Author Radu Popescu believes that the promotion of change requires the development of a link between research producers and consumers; moreover, the increase in the concerns for ensuring a highly qualified workforce and the quality of government policy are important in this direction. In his opinion, Romania needs a systemic nurturing of the capacity to create and harness scientific and technological

knowledge; in this regard, their development requires creating a high scientific and educational level, comparable to the global one; promoting behavioral patterns toward entrepreneurship and innovation, in order to encourage lifelong learning by organizations and individuals. Looking in this direction, a number of strengths and weaknesses can be identified for Romania:

##### **Strengths:**

- development of information and telecommunications infrastructure;
- concern for the gradual assimilation of modern technologies;
- development of the online economy.

##### **Weaknesses:**

- Romanian small private enterprises have less than the number of staff necessary to be competitive internationally;
- the reorganization of large privatized enterprises was made by the reduction of staff;
- failure to attract sufficient foreign direct investment for productive capacity-building;
- a relatively large decrease of the economy, rising unemployment.

*"The task is to modernize the knowledge and competencies/ skills used especially in labor infrastructure, processing and increased productivity, in Romania. Therefore, Romania should develop its systems and structures that have proven effective in the advanced economies of the EU countries, and it should also develop its innovation systems, in these directions, in time." [4]*

Romania should take into account the contribution of knowledge and innovation in its development process. Now, more than ever, knowledge is the main renewable and sustainable resource for Romania.

The development of the knowledge based economy in Romania entails intervention measures in the following areas: investment in education, in order to develop the human capital and to boost the processes for the use and dissemination of knowledge; development of the research and innovation systems based on partnerships between companies, research centers, universities, in order to increase the global stock of

knowledge; integration and use of ICT in all economic sectors.

If we think about what can be done and what must be done in Romania, for the transition to the knowledge based economy, we should turn our attention to the need to create a strategy for this transition. Subjects related to knowledge economy, organization and management should be introduced in the curricula. Young specialists in the knowledge based economy should be trained, because this area requires the creativity, the innovation and the prospective dimension that only young people have.

Unfortunately, Romania does not have such a strategy. The achievement of such a strategy requires a team made up of domestic and international specialists covering the three dimensions of the knowledge based economy – i.e. economic, social and environmental; it should have opinion leaders; moreover, time and resources should be allocated. If this strategy is not implemented, the immense opportunity represented by the transition to the knowledge based economy is unlikely to be harnessed. It is very important to make concrete steps, to share this knowledge; otherwise, we will not progress and will lose this opportunity.

## 5. Conclusions

In order to analyze a country's ability to compete in a knowledge-based economy, the World Bank established the Knowledge Assessment Methodology (KAM). This methodology is based on structural and qualitative variables and a group of countries, which includes most OECD economies

**The Knowledge Index (KI)** is a tool created by the World Bank in order to measure a country's ability to generate, adopt and disseminate knowledge.

**The Knowledge Economic Index (KEI)** measures the general level of development of a country or region, emphasizing that the environment of the respective country or region is favorable to the use of knowledge for economic development.

In conclusion, Romania needs improvement across all four pillars of the Knowledge Index and Knowledge Economic Index (economic regime, education, innovation and ICT), in order to become an

environment which harnesses knowledge for economic development.

## 6. References

- [1] [www.epp.eurostat.ec.europa.eu](http://www.epp.eurostat.ec.europa.eu)
- [2] Radu Popescu, „Actualitatea economiei cunoașterii. Viitorul României în Economia Cunoașterii”, Tehnologie Inovativă, Construcții de Mașini- Review – New Series, Year 62, No. 3/2010, pp. 45-48
- [3] Radu Popescu, “Managementul proprietății intelectuale”, Tribuna Economică Review, no. 5, Tuesday, 6<sup>th</sup> february, 2008, pp. 88-89
- [4] Radu Popescu, „Economia cunoașterii și strategia de dezvoltare”, Tehnologie Inovativă, Construcții de Mașini Review – New Series, Year 62, No. 3/2010, p. 45
- [5] <http://info.worldbank.org/>

## Excellence in Objective Strategic Education in the Military University

Liliana Nicodim

*Faculty of Economics, "Ovidius" University, Constanta, Romania*

[nicodimlili@yahoo.com](mailto:nicodimlili@yahoo.com)

Gabriel-Iulian Tănase

*Valahia University of Târgoviște*

[tenessist@yahoo.com](mailto:tenessist@yahoo.com)

Marian Velica

*Valahia University of Târgoviște*

[velicamarian@yahoo.com](mailto:velicamarian@yahoo.com)

### Abstract

*The evolution of the Romanian Army is marked and sustained by military schools, which, over time, regardless of form, structure or organizational level, were veritable pillars of its functionality. Higher military education system has the task of initial and ongoing training, advanced training of specialists and officers according to the needs of the Ministry of Defense through undergraduate studies, master's, doctorate and postgraduate education. Teaching quality has become an issue of importance to the training process in higher education facing continuous changes: increasing national and international competition, increasing social level, geographical diversity of the student body, increasing need of quality training, introduction of information technologies, and so on.*

**Key words:** military education, quality training, excellence, European integration

**J.E.L. Classification:** M1; M10; M19

### 1. Introduction

The Army is, as shown in "The relations between the military and society in the process of European and Euro-Atlantic integration of Romania"[1], an important state institution, invested with complex missions for the defense of independence, sovereignty, integrity and territorial unity of the country and guarantee of constitutional democracy in the country. In addition,

through Romania's integration in NATO and its accession to the European Union, its responsibilities have increased in regional security and more. As a result, the army is able to fulfill both constitutional internal tasks and diverse international assignments ranging from the humanitarian to the crisis management and combating international terrorism. In this context, it is clear that the army must be compatible with the requirements of the Romania's statute of being a member of NATO, but also with the mutations produced in all the sectors of Romanian society. In this way, it is able to better serve the objectives that our country sets, as a sovereign state and, at the same time, NATO member. The military must be leaders, trainers, educators, specialists and responsible for training and education of subordinates. Liability for subordinates is considered "the center of gravity of the army in peacetime" in the opinion of Ion Cojocaru in "Military Education Bulletin". The understanding of the vital importance that is represented by the quality of the command staff has generated constant concern to provide "the military a thorough, solid specialty training" as show by first Romanian military historian, Nicolae Bălcescu, stressing at the time the need for organizing a "well thought out and structured" military education system. Inevitably, the process of formation bears the imprint of socio-historical and military characteristics specific to different periods of the tumultuous existence of the Romanian people. The continuity of the education process records, in this way, developments that incorporate the full range of specific ways, from the

simple transfer of experience between generations, to the modern systematic approach, in terms of curriculum and training.

## **2. Considerations regarding the higher military education system**

Romanian military education, an area of strategic importance, is open and receptive to the European and euro-Atlantic novelty, and the units and military institutions have accepted the challenge of playing an important role in constructing the European area of education, along with all the other educational institutions in the country.

Integration into the European Union, as well as Romania's Army missions resulted from membership with full rights and obligations of NATO assumes rallying to the value system of these organizations, including in the field of military education. Compatibility with training, specialization and improvement of the professional military personnel from the NATO armies remains one of the vital factors in the transformation process.

Higher military education is done in four institutions under the authority of the General Staff (Military Technical Academy and three academies with categories of military forces) accredited by the Romanian Agency for Quality Assurance in Higher Education (RAQAHE), one subordinated to the Medical Service (Medico –Military Institute) and two institutions subordinated to the Minister of National Defense, under the coordination of the State Secretary for relations with Parliament, public information and welfare (National Defense University "Carol I", accredited by the Romanian Agency for Quality Assurance in Higher Education and National Defense College).

Higher military education institutions are arranged in 4 garrisons and 6 locations and provide the training, improvement and specialization of officers according to the requirements of the Romanian Army. The educational proposal of higher military education institutions includes study programs for undergraduate, masters and doctorate, as well as postgraduate courses.

## **3. Excellence in the national and international education system**

The European dimension of education is given by the Bologna Process, which is based on a programmatic document "An Europe of Knowledge is now widely recognized as an irreplaceable factor for social and human development and an indispensable component to consolidate and enrich the European citizenship, capable of providing its citizens with the necessary skills to face the challenges of the new millennium, together with an awareness of shared values and belonging to a social and common cultural space"[2] ("Bologna Declaration", 1999) adopted by all ministers responsible for higher education in the member countries, as well as communiqués signed by ministers responsible of education at the meetings in Prague (2001), Berlin (2003) and Bergen (2005). The strict application of the provisions laid down at a European level depends on national quality assurance agencies, and therefore RAQAHE, in the ENQA (European Network for Quality Assurance in Higher Education). Also, by putting the universities in our country in the European Higher Education Area, the confidence in quality is ensured and through higher level the academic and/or, where appropriate, Romanian professional qualification recognition is obtained. The internal dimension of academic quality is carried out in existing legislation and depending on the specifics of each university, tradition and cultural heritage of higher education in our country. It is the full responsibility of each university and each provider of education programs. In this respect, quality assurance becomes a process according to the specific institutional framework and establishes itself as a mechanism by which the results or academic performance are always improved.

Reference principles underlying the quality of higher military education can be stated as follows[3]:

**European reference** ensures the affiliation of the system and higher education institutions in the European Higher Education Area and ensure quality levels in line with the requirements of this area and competitive on an European and international level.

**Institutional responsibility** believes that responsibility and managing the quality assurance are of accredited universities competence, conforming to the university autonomy.

**Institutional diversity** provides diversity of institutions, their mission and objectives which is respected and supported by external quality assessment.

**Cooperation with all the components of the educational system** considers addressing, applied practices and forms of technical assistance offered by RAQAHE leaning on relations of cooperation and mutual trust in relations with higher education institutions and other partners.

**The focus on learning outcomes** causes the results in education and the performance in university research to occupy the central position of reference in quality assurance and evaluation.

**Institutional Identity** believes that the results and performances in education and research can be achieved through a variety of practices, methods or structures, designed and implemented individually by each institution according to its own choices. Because of this the most important weight in RAQAHE evaluations is given especially to the results and performances, without neglecting the influence of good practices and successful structures in academic quality.

**Internal, institutional self-evaluation of quality** deems that each self-evaluation document must show the specific quality culture in higher education institutions and ensure continuity of performance improvements.

**The external evaluation** should be based on the demonstration of higher education institution results and performances in teaching and research and the verification of their relationship with the true reality of the institution, including the verification of student activity in relation to the standards acquired.

**Continuous improvement of quality** and institutional management are considered as the main objectives of the external evaluation.

Defining excellence in higher education is not a simple task, even if there are several definitions, selecting an universal sense is complicated, because it depends on the social and cultural environment (values and

principles, for example) as well as political and economic contexts. Expectations and priorities of different groups is influencing the perceptions about excellence in higher education. Therefore, excellence in higher education depends on the definition of the term and the motivation of the people participating in getting it.

Excellence can be a concrete reality, a permanent move, or only a horizon. In other words, excellence can be some combination of inputs and outputs (even measured in quantities), a culture in the use of inputs and progress in order to obtain better outputs or the fulfillment of the proposed objectives. When excellence is seen as a concrete reality, focuses on the problem of defining the limits of excellence. In many areas, the term excellence is traditionally linked to quality, namely the achievement of objectives over the normal standards and normal threshold limits. Exceeding these limits can define excellence as an exclusive state. Another approach to the definition of excellence refers to its compatibility with many global definitions within the global company's activity and its prospects in obtaining them.

A classic definition of excellence refers to achieving a certain standard, a measure of performance in accordance with a predefined set of standards. A different interpretation of excellence, based on innovation, can lead to a peculiar situation by obtaining unexpected results, above those expected.

Also, the definition of excellence should consider the use of quantitative and qualitative parameters or the use of objective and subjective indicators.

Taking into account all these points will facilitate the identification of an adequate definition of what is excellence in higher education.

Educating a large number of people to a high standard through assimilation of knowledge can be considered as one of the main objectives of today's higher education sector. Given that stakeholders (students, administrators, faculties and various public entities) are from various sectors of society, making the higher education sector, very complex, difficult and competitive. In the higher education sector to be excellent can be interpreted as "very good" or "exceptional".

Excellence is part of a process where competence is the starting point. For this



reason, it cannot be defined as a simple result. Excellency, which permanently appears in the missions of several universities, is not yet well defined in academic publications, making the assessment of excellence to be achieved less objective and often unwieldy. Unclearness of the term excellence in standardized form makes questions like "What is excellence?", "Excellence for what?" and "Excellence in what?" to have answers that vary. Excellence can be defined in general terms as having features that are exceptional. Specifically, excellence is closely linked to quality and according to the traditional view, links quality with the term exceptional. Thus quality can be considered as a special situation, not always or in terms fulfilled. Quality refers to something special and, in terms of education is linked to concepts of excellence, standards that must be met and to which many institutions or scientists aspire. If excellence can be interpreted as a concept closely linked to an individual virtue or quality, global changes have transformed it into an organization characteristic, a result of the high level of quality that distinguishes the best universities from the others. Therefore, there is a growing focus on vertical stratification, which promotes an "aura of exceptionality". Thus, the evaluation systems of higher education, excellence is equated with the term "being the best" which could mean, the fulfillment by education institutions of standards for more features, as listed by Altbach[4]:

- Excellence in research;
- High quality teachers;
- Favorable working conditions;
- Job security, benefits and a good salary;
- Adequate facilities;
- Adequate funding, including predictability each year;
- Academic autonomy.

The quality of teaching is a permanent key issue in higher education faced with constant change. Learners have diversified both socially and geographically. Thus emerged the need for new teaching methods and technologies, changing the nature of interactions between students and teachers. Specialty state institutions, students and their families, employers, fund providers

increasingly require add value to their investments and want greater efficiency through teaching. Teaching can not be unitary defined and to some extent, can not be disconnected from the debate on quality or culture quality in higher education which remain permanent terms in current times. Studies conducted primarily consider quality as a result, others as a property and in terms of teaching an endless process to reduce defects.

In this sense it can be said that "good teachers" have empathy for students, are expressive, being experienced teachers, with organizing capacity. Instead the "excellent teachers" are those that have passions: passion for learning, their field, teaching and their students. Quality teaching is student-centered, the aim being to adapt it to the needs of education. Thus, we should pay attention not only to the pedagogical skills of the teacher, but as well to the learning environment that needs to respond to students' personal needs. Financial, social, support including minority students and the existence of advisory services lead to improved learning outcomes. Learning through intellectual interaction between community groups - groups of students and/or teachers who give birth to necessary knowledge to improve the learning process by increasing student preparation and teacher satisfaction. Teaching can be enhanced with the help of teachers and on institutional or national departmental level.

Improvement of quality in this effect can be achieved by improving teaching methods and by adapting to the needs of the learning environment. The exchange of experience, teamwork, setting goals, studies, collecting information provide a better quality of teaching. Measuring the effectiveness of the teaching is done by analyzing indicators for measuring the quality of teaching in order to determine the value of graduates' satisfaction with teachers, the retention rates, etc. The use of pupil satisfaction surveys are another method of measurement, but with the perception by teachers that they are subjective, students give biased answers blaming teachers for everything that is not as expected, without taking into account the role of government.

The educational process conducted in the military education system follows a model of

excellence in teaching and learning that is characterized by[5]:

- student-centered teaching, adapted to their needs to the detriment of formal teaching;
- tailor the curriculum to the needs of the beneficiaries of the educational process, while adapting the work environment to deliver results within terms of excellence;
- use of satisfaction surveys applicable on students to achieve feedback on the work of the teacher, in order to evaluate him or to adapt teaching to the needs of learners by developing personal knowledge and by using a proper working environment;
- continued involvement of all teachers in the development and innovation of teaching and the use of effective educational leadership;
- stimulation, through various methods, of all participants in the educational process, with the purpose of influencing its position;
- excellence is used in a performance system, with the objective of increasing the efficiency of human resource in teaching and learning needed to fulfill the economic objectives set at national level.

The future of higher education could bring new and high considerations regarding the quality of teaching. One of the developments in the foreseeable future higher education is in the process of globalization. This rapid process has many consequences on higher education around the world, consisting in conducting international mobility, global comparisons, making benchmarking and rankings as well as internationalization of institutions and systems, those becoming major issues for the political system. The division between teaching and research as well as the increasing technological features may have an indirect impact in the teaching comprehensive. Permanent orientation of universities towards total quality in educational processes, creates an open space for carrying out joint projects, initiated both by them and by the stakeholders and carried out in evolutionary partnerships. Creating

valuation and attracting resources will be the potential development result of adapting to the requirements of stakeholders, with reference in research and training. In the training programs proposal rapid responses to the needs of employers will be created, students and former graduates, causing a "hard point" in the management of universities. Training initiatives undertaken in relation to the stakeholders will permanently include a research component or applied knowledge transfer.[6]

#### 4. Conclusions

It is not enough to accept that excellence is a reflection of the reputation of institutions and academic departments in order to obtain a representative position of their evaluation process. Reputation is gained over a long period of time and is strengthened by research experience, knowledge gained, social interaction and the formation of a vibrant and productive academic community. Education is seen as a socialization process where students are influenced by the values, the culture and ethos of education institutions. This, however, does not guarantee an excellent learning experience for students and does not guarantee their determination in achieving their objectives. Elite institutions often attract the most able students, but can not guarantee the sure success of learners, being influenced by their attitude.

Excellence can be measured against accepted and applicable standards across the range of academic disciplines and all educational institutions, being a relative concept that can reflect variables between them and the characteristics of learners.

#### 5. References

- [1] Moștofleu Constantine, Nicholas Dolghin Peter Duțu, "*Relations between the military and society in the process of European and Euro-Atlantic integration of Romania*", University of National Defense "Carol I", Bucharest, 2005.
- [2] *Bologna Declaration of 19 June 1999* [www.bologna\\_bergen2005.no](http://www.bologna_bergen2005.no) accessed during 13-16.03.2015.
- [3] "*External evaluation methodology*", the Romanian Agency for Quality Assurance in Higher Education, Bucharest, 2006.

- [4] Altbach, PG (2004), "*The Costs and Benefits of World-Class Universities*", *Academe*, vol. 90, no. 1, p. 20-23
- [5] Gibbs, G., (2008) "*Conceptions of Teaching Excellence underlying Teaching Award Schemes*", The Higher Education Academy, York, pag.19-20
- [6] Adriana Grigorescu, Mirela Luminița Olteanu, (2014) "*Stakeholder Perception Of The Process Of Change In Romanian Undergraduate Education*", *Review of International Comparative Management*, Volume 15, Issue 4, October 2014

## African American Slavery - a Social Ecological Approach

Dragoş Osoianu  
Ovidius University of Constanţa  
Graduate School of Humanities  
[os\\_o82@yahoo.com](mailto:os_o82@yahoo.com)

### Abstract

*This paper aims to briefly explore American slavery from a social ecological point of view. As a historical and economic institution, this (pre)capitalist structure is related to social hierarchies of power in which a cultural dichotomy is anchored within the inner fabric of a specific society. Thus, there are contiguous oppositions between the white and the black, man and woman, human and nature, identity and alterity. This societal antinomy has been exported to Nature in such a way that both human slaves and the environment are apprehended as commodities satisfying the white people's economic or personal needs. Nevertheless, the binary opposition of master and slave or Nature represents a cultural construct and it ought to be deconstructed in order to show that there is an ontological or, at least, axiological continuity between the oppressor and the oppressed, between the economic structures and the environment.*

**Key words:** slavery, Social Ecology, power, property, nature

**J.E.L. classification:** Z13, Y80, Q50, P14

### 1. Introduction

"There is nothing notably peculiar about the institution of slavery. It has existed from before the dawn of human history right down to the twentieth century, in the most primitive of human societies and in the most civilized." [1]. As a state of being and, consequently, of "having", slavery had existed from time immemorial, beyond the boundaries of history or societal and collective memory. In the United States, a change of paradigm occurred when, in 1864, Abraham Lincoln suggested that slavery is not compatible with any given political or natural state of a

person: "I am naturally anti-slavery. If slavery is not wrong, nothing is wrong" [2]

American slavery represented an aftermath of the prior British authority; nevertheless, the new-born federal country institutionalized it as a legal human chattel. Preserving cultural and historical hierarchies of power, gender and class, this criminal institution also promoted multiple acts of discrimination related to race, identity, economics, natural and civil rights. From a social ecological point of view, various dichotomies may be conceptualized and discussed upon them: master - slave, owner - property, person - property, subject - object, human - non-human, civilization - wilderness, society - nature.

### 2.1 Theoretical Background - Social Ecology

The critical social theory of *Social Ecology* was initiated by the social anarchist Murray Bookchin. His societal vision is related to a "libertarian society" and a "classless" community [3], in which hierarchies are overcome and everyone is equal to everyone. Being a promoter of decentralization and democratization, he profoundly disapproves the inequities and the hierarchies of power and control within the society. Thus, in a chain of political and structural ideologies and ecologies, he considers that "the very domination of nature by man stems from the very real domination of human by human" [4].

This inter-human domination is conceptualized as having economic, ethnic, cultural and gender roots, from which hierarchical dualities function as means of exerting power. The apex of the ecological conflict is fully achieved in the modern and capitalist society, where nature becomes a commodity and urban environment replaces organic space. In order to be sustainable, a

society ought to maintain a solid cybernetic balance between the environmental and economic needs, as seen in this diagram:

Figure 1. "Three pillars of sustainability"

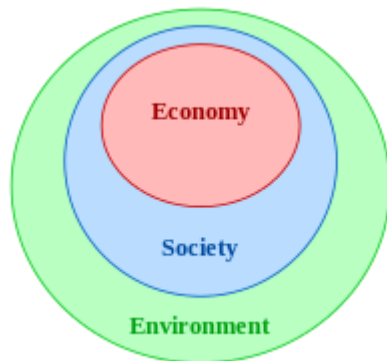

Source:

[https://en.wikipedia.org/wiki/Sustainability#/media/File:Nested\\_sustainability-v2.svg](https://en.wikipedia.org/wiki/Sustainability#/media/File:Nested_sustainability-v2.svg)

Hence, the ecological crisis is real and it has its roots within the society, the same methodological and causal chain mentioned above functioning as it follows: the damaged alterity of the modern man creates conflicts of difference and domination; these hierarchies of power and control are objectified into the societal structures; these overpowering structures exert a psychological and existential pressure over the individual mind; the human subjectivity externalizes his previous internalized conflict into the natural environment. In this manner, the society exports its inner hierarchy of power into nature, the conclusion consisting in the fact that the ecological crisis stems from a cultural crisis, all through the agency of man. Social Ecology could be epistemologically connected to the theories of Bateson or Guattari, in terms of the related ecologies of mind, nature and culture, all them being mutually influenced.

Human societies, in general, have focused on owning, property and their relationships, ignoring the natural bound between human beings and the environment; they "dissolved into market relationships that the planet itself was reduced to a resource of exploitation". The "exacerbating development in modern capitalism" has led to a distressed aftermath: "Just as men are converted into commodities, so every aspect of nature is converted into a commodity, a resource to be manufactured and merchandised wantonly" [5]. In the second figure, one can see the interdependent

relationship between the realms of society, economics and environment; they are not to be mutually and consubstantially segregated.

Figure 2. Scheme of sustainable development

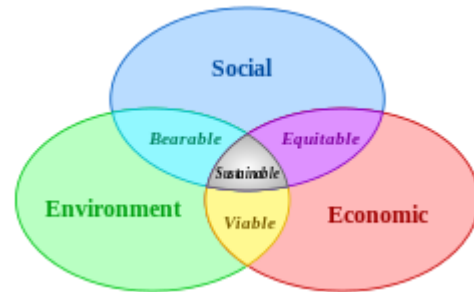

Source:

[https://en.wikipedia.org/wiki/File:Sustainable\\_development.svg](https://en.wikipedia.org/wiki/File:Sustainable_development.svg)

## 2.2 Theoretical Developments

A contiguous concept to Social Ecology is *Social Anarchism* which embraces both anarchism and the civic fight for individual freedom. This freedom is not egoistic, being generated by mutual relationships from a specific community; the interplay between multiple agencies, and individual and group identities lead to a hybrid objective-subjective reality, where the truth is institutionally deconstructed and, at the same time, shared by individuals within the same identitary group: "The objective history of the social structure becomes internalized as a subjective history of the psychic structure" [6].

This rational marriage between the potentialities of society and subjectivity could lead to a *Post-Scarcity* and mildly institutionalized system, wherein freedom, individual choice and cybernetic equilibrium represent premises for economic and ecological sustainability. Issuing from the assumption that "the existence of hierarchical relationships.....would serve to perpetuate unfreedom" [7], one can notice that a societal immanence is required in order to freely act as fully persons, not as merely as individuals avid for hierarchical and non-democratic accumulation of capital.

Furthermore, a post-scarcity paradigm, conceptually and methodological different from the economic post-scarcity model, focuses mainly on a virtual post-industrial

society, wherein the cultural opposition between the capitalist consumer and the environment destroyed by technology is abolished.. Thus, the concept of *Dialectical Naturalism* may be introduced, a post-Hegelian way of thinking, which emphasizes the interrelationship between social structures and their interactions within the environment; the focus is not on a philosophical synthesis, but rather on a continuous process of becoming and mutual differences between individuals.

Another form of Social Ecology is taken by the so-called *Kyriarchy*, a concept related to domination, submission and oppression. It is an intersectional extension of the patriarchal and social dominance of the privileged over the oppressed, this unnatural relationship being systemic and institutionalized. The etymology is conclusive: from the Greek *κύριος* (*kyrios*), which means lord/master, and *ἄρχω* (*archō*), which means to lead/to rule; it shows the dichotomy master-slave or man-woman. Interdependent and stratified categories of gender, race, class, religion, heterosexuality and age construct the social identities of specific human beings, their freedom being thereby irrelevant. [8]

As indirectly mentioned above, another concept is *Intersectionality*, the categories of domination and discrimination being here pre-contextualized through a social and gendered injustice; thus, multiple threads of inequality and societal hierarchies are being displayed and multiple identities are created. Having been mainly applied to black gendered discourses, Intersectionality deals with oppressed and marginalized groups which are socially and powerfully racialized and gendered; on this line, social and cultural justice is needed. [9]

### 3.1 Racialized Hierarchies of Power

Slavery, as a cultural and historical paradigm, was pervasive in the first half of the nineteenth century in the United States. That society displayed massive social and economic inequality, and segregation represented the means by which society showed that the white population was in control. This kind of civilization constructed different racial identities wherein the social roles of the black functioned as societal

extensions of the white. Negroes were perceived as others and the only essential identity belonged to the dominant citizens. Thus, an opposition between white identity and black alterity arose; their relationship materialized through obvious hierarchies of power. The dominant and white subject externalized one's authority by objectifying the former black subject, the latter having become merely a social and economic object.

These divisions within the United States society have persisted and have been conceptualized as "given", not as processes of becoming [10]. Furthermore, this cultural vision relates to various prejudices concerning ethnicity, gender, class, religion, housing or employment. Its ongoing dynamics consists in the continuous interplay between the privileged and the oppressed, between those who have institutional power and those who must obey the system. These facts are in a close relationship with the social ecological point of view because of the long-lasting perspective of domination of the strong over the weak. The black weakness relates nevertheless to white domination in an unjust vicious circle; afterward, the dominant societal structures had created alterity and exactly this alterity is condemned to be different and exploited.

Creating psychological, idiosyncratic and group alterities, the dominant (white) group has externalized essential differences to society, meaning that the dichotomy white-black, in which power is segregated, has been institutionalized. The overall system behaves as a structure of power and hierarchy, in which the oppressed is the object of exploitation and becomes capitalist commodity. This unbalanced domination is later exported to nature and, from a social ecological point of view, the human being is no longer part of Nature, but an actant outside of it. The natural landscape represents only an environment, exterior to the human realm of perception, ready to be used economically and egoistic as a commodity, according to strictly capitalist needs.

Thus, the state of ecological equilibrium is disturbed, the immediate consequence consisting in the fact that the axiological and ontological continuity between the social, individual, economic and natural ecologies would fall apart. An affinity between the

economic exploitation of the environment and of the black is to be acknowledged, especially when both categories are apprehended as commodities. From a postmodern perspective and, of course, social ecological, this binary opposition ought to be deconstructed in respect that there is no essential difference between them; this segregation has cultural roots and it is artificial, exactly like the alterity established for reasons of hierarchical power.

### 3.2 Slavery - Power and Property

Carrying forward the previous ideas, a generalization has to be made in order to better understand the fabric and teleology of the structures of power. On this line, one may notice the fact that "all human relationships are structured and defined by the relative power of the interacting persons.....Relations of inequality or domination, which exist whenever one person has more power than another, range on a continuum.....total power over another" [11]. Slavery is the most extreme form of domination and of exerting power, being a state of master's total power and of slave's total domination. This social kyriarchy circumscribes the oppressed (the black slave) to the despotic rule of the oppressor, the former representing only an objectification of the latter's will of power.

This state of submission has its dialectics in the patriarchal vision of a powerful center around which epistemic objects gravitate. Thus, the slave is epistemologically constructed as an object by the subject who owns the power of observation and control. This brutal and existential domination stems from the unnatural bond between the owner and his property, in this case, the slave, conceptualized here as a commodity or a commercial good who/which circulates within the cultural prerogatives established by the empowered master. The slave's social roles are "given" by birth and are essentially institutionalized so that the structural relation of power be considered "natural", an aspect "transcendental" to societal critique; after all, what is natural cannot be inquired.

Thereby, a social and historical construct is naturalized by means of force of power; the direct consequence consists in the fact that the quality of being natural or even existing as Nature becomes a property of the

human owner who owns what or who is outside of him/her, the environment or the slave. Thus, an axiological, epistemological and even ontological relationship between Nature and Slave is established by the master. These existential categories are perceived as outsiders, as patrimonial capital, and as alterities, as objects configured by the thinking subject. The slaves are "othered" by their owners and this represents the main condition for them to be manipulated; by having been externalized and having a lesser degree of humanity, they could be apprehended as not holding the same ontic value as their masters.

This ownership relates to property, meaning that the black people's function was to serve the landlord's personal or economic goals. "The power relationship is no longer viewed as power over persons but as power over commodities" [12]; as economic goods, slaves were depersonalized in order to accomplish their social roles. From an intersectional point of view, the categories of power and property also encompassed women of color, who, beyond their racialized social roles, were, more or less, gendered victims of domestic and sexual abuses. The intersection of multiple threads of oppression related to black females led them to share a greater cultural and physical pain than many of black males. Their body was transgressed to serve as means of labor and pleasure, various anti-natural behaviors having been experienced and suffered.

As shown before and from a symbolic perspective, continuing the idea according to which both Nature and slaves are the objects of the owner's will and power, the dichotomy master-slave may equal to the opposition between human and the environment. Furthermore, there is also an opposition between the Gaian Nature, apprehended as the feminine principle, and the Uranic/patriarchal/transcendental center of power; although they share the same divine origins, meaning that they should have equal "economic" rights (dwelling the same "oikos" or natural home), the latter dominates the former by exerting hierarchies of power and property. Corroborating the prior idea with the fact that the state of being black is ecocritically related to wilderness of Nature, the structuralist view of women of color represents the perfect iconic image of the

oppressed as property.

#### 4. Conclusions

Slavery, as a historical, cultural and economic institution, had an important role in the post-colonial and capitalist United States. Its development also led to a political departure from the British influence. The hierarchical structures of power established within these territories represent the main cause for racial and gender discrimination and, as a direct effect, for raising the cultural dichotomy master-slave. Thus, the state of slavery is conceived as having been "given", beyond individual choices or free will; in other words, this structure transcends idiosyncratic or even group identities and becomes institutionalized. The power belongs to those who exert authority, meaning the white. This social paradigm has essentialist origins and establishes a solid opposition between the racialized and gendered slaves, and the master's power.

From a social ecological point of view, the dissociation from a democratic perspective makes that these hierarchies of power to be exported to the environment; both slaves and Nature are "othered" and apprehended as alterities, commodities or economic goods, ready to be exploited in order to satisfy the oppressor's needs. Continuing the social ecological thought, we may acknowledge the fact that there is no ontological difference between the institutional subject, the white male, and the epistemic object of thinking, the black female or Nature. The binary opposition of masters and slaves ought to be post-structurally deconstructed and recoded within a new immanent context, where all human beings share the same axiological and natural space and where the economic value follows the humanistic interests.

#### 5. References

- [1] Patterson, O., *Slavery and Social Death: A Comparative Study*, Harvard University Press, Cambridge, p. VII.
- [2] Lincoln, A. to Hodges, A.H. April 4, 1864 <http://www.abrahamlincolnonline.org/lincoln/speeches/hodges.htm>.
- [3] Bookchin, M., *The Ecology of Freedom. The Emergence and Dissolution of Hierarchy*,

- Cheshire Books, Inc., Palo Alto, 1982, p. 3.
- [4] Bookchin, M., *The Ecology of Freedom. The Emergence and Dissolution of Hierarchy*, Cheshire Books, Inc., Palo Alto, 1982, p. 65.
- [5] Bookchin, M., *Post-Scarcity Anarchism.*, AK Press, Oakland, 2004, pp. 24-25.
- [6] Bookchin, M., *The Ecology of Freedom. The Emergence and Dissolution of Hierarchy*, Cheshire Books, Inc., Palo Alto, 1982, p. 8.
- [7] Bookchin, M., *The Ecology of Freedom. The Emergence and Dissolution of Hierarchy*, Cheshire Books, Inc., Palo Alto, 1982, p. 3.
- [8] Fiorenza, S.E., "Introduction: Exploring the Intersections of Race, Gender, Status and Ethnicity in Early Christian Studies", *Prejudice and Christian Beginnings: Investigating Race, Gender, and Ethnicity in Early Christian Studies*, Fortress Press, Minneapolis, 2009, pp 1-23.
- [9] Crenshaw, K.W., "Demarginalizing the Intersection of Race and Sex: a Black Feminist Critique of AntiA Politics", *Chicago Legal Forum: Feminism in the Law: Theory, Practice and Criticism*, The University of Chicago Press, Chicago, 1989, pp. 139-167.
- [10] Ladson-Billings, G.J., "Just What Is Critical Race Theory and What's It Doing in a Nice Field like Education?", *International Journal of Qualitative Studies in Education*, Taylor and Francis, London, 1998, pp. 7-24.
- [11] Patterson, O., *Slavery and Social Death: A Comparative Study*, Harvard University Press, Cambridge, p. 1.
- [12] Patterson, O., *Slavery and Social Death: A Comparative Study*, Harvard University Press, Cambridge, p. 19.

*This work was supported by the project "Sustainable performance in doctoral and post-doctoral research - PERFORM" co-funded from the European Social Fund through the Development of Human Resources Operational Programme 2007-2013, contract no.POSDRU/159/1.5/S/138963*



## Quality-oriented Organizational Culture

Anca Cristina Stanciu

„Ovidius” University of Constanta, Romania

Faculty of Economics Sciences

[castan22us@yahoo.com](mailto:castan22us@yahoo.com)

Mihaela Constandache,

„Dimitrie Cantemir” Christian University of Bucharest, Faculty of Tourism and  
Commercial Management Constanta

[mihaela\\_constandache@yahoo.com](mailto:mihaela_constandache@yahoo.com)

Daniela Simona Nenciu

„Dimitrie Cantemir” Christian University of Bucharest, Faculty of Tourism and  
Commercial Management Constanta

[nenciu75@yahoo.com](mailto:nenciu75@yahoo.com)

### Abstract

*In order to develop the quality it is necessary to move from an existing culture to a culture of quality. When referring to the important functions of any organization to create a culture solid such as dissemination of quality philosophy, staff motivation and group cohesion, we realize the obstacles in creating such a culture. The main function of the organizational culture is to give members of the organization both organizational identity and to generate a commitment to shared values and principles. Although the literature discusses frequently the links between cultural changes in order to create a culture of quality, the practical approach is still problematic. In this purpose, the primary mechanisms recommended to convince employees of the need to introduce and implement a culture of quality are education, training and leadership, while the structure, systems and procedures are important, but secondary.*

**Key words:** quality,culture,organization.

**J.E.L. classification:** L21,M10,M14,M29.

### Introduction

Culture and organizational performance are clearly interrelated, although evidence on the exact nature of these relationships are heterogeneous. Effective achievement of

organizational objectives related to quality generally requires radical change of system.s mindset, broadly defined as corporate culture. In this context, quality culture is a specific form of cultural organizations

Oriented to high levels of quality and performance, defined as a culture that promotes social relationships of trust and respect for individuals, a sense of belonging to the shared organization and belief that continuous improvement is for the common welfare.[1]

Building quality culture is based on understanding the laws change in an institution or an organization. This requires knowledge of the evolution of culture in each organization. It is known as staff of an organization feels moments when some changes are imposed and therefore must know that all stakeholders must be involved in planning and implementing changes to give assurances that everything goes in the right direction. Strategies for building quality culture are diverse, depending on the place and the staff of the organization. They have undergone extensive studies and debates which finally led to increasing responsibility of all regarding the concept of quality culture. It seeks to create a new concept for the organization that lead to overcoming gaps or inaccuracies with negative influence in the organization.[2]

Although the literature discusses frequently the links between cultural changes

in order to create a culture of quality, the practical approach is still problematic.

## **2. Quality management in the context of organizational change**

In order to develop the quality it is necessary to move from an existing culture to a culture of quality. When referring to the important functions of any organization to create a culture solid such as dissemination of quality philosophy, staff motivation and group cohesion, we realize the obstacles in creating such a culture.

Organizational culture can be defined as an assembly split in opinions, values,

attitudes and behavior patterns that characterize its members. This system of views and values taking place within the organization, guides all the branches, being a constant reference point.[3]

Personalities in the field made numerous exposures on the need to implement in the organization, regardless of size, of a quality culture appropriate to place, time and type of employees. One of the strongest proponents of the concept was JM Juran, quality science and theorist who proposed and implemented the concept of "conflict of cultures", meaning the structure of those who want change and those who do not want, that are against.[2]

Developing a total quality system involves to create a so solid culture that promote and perform important quality functions such as: dissemination of quality philosophy, staff motivation and cohesion in groups according to given tasks.

Total Quality Management(TQM) is a philosophy quite enough attractive, but its implementation involves many difficulties. The implementation of the total quality management requires a deep transformation of the organization so that it is inevitable the emergence of a strong resistance.[4]

A culture based on performance and quality/customer-oriented must promote practices such as delegation of tasks, powers and responsibilities; teamwork with strong leadership; correlating and integrating human resources with technology, employees being the ones responsible for how the potential of the technical to make better the use of the human potential and enhance performance;

orientation towards a common goal.[5]

Total Quality Management is based on the knowledge of the organization development and its environment and through continuous improvement, seeking to reach stages closer to excellence. It is well known that the quality management system implementation depends on the particularities of each organization. Although the ideas that become part of the organizational culture can come from anywhere within the organization usually starts with an organizational culture founder or one of the first leaders who generate and implement certain ideas and values like vision, philosophy or strategy. When these ideas and values are changed into positive results and give benefit, they become institutionalized and incurred an organizational culture that reflects its founder's vision and strategy of the leader.

## **3. Issues and factors concerning the implementation of the quality culture**

The models used commonly in quality management stresses change based on cultural elements focused on quality; therefore, it is necessary that managers identify the need for a cultural change.

However, cultural change is conditional by the following:

- the organization is going through a major crisis;
- change of the leadership;
- organizational culture is weak;
- organization is small or/and very young;
- company performance is mediocre or poor;
- organization grows rapidly;
- the company is about to become a corporate giant.[1]

But at the same time, any change is possible when there are a number of favorable factors such as:

- a consistent communication, enabling employees to realize the need to implement tools and techniques for improving the quality;
- personal example and dedication of the top leaders;
- employees talk about processes and not about functions;
- in some of departments of the organization appear leaders of quality;
- employees express their opinions freely and

voluntarily resume some tasks and tighten show willingness to help others;

- employees are considered by the top management capital ,not costs;
- employees from operational levels began to provide ideas to the upper echelons;
- continuous improvement takes place even in times of instability.[6]

All the issues underlined above indicate the need and the presence of the quality management system based on the TQM philosophy,in fact the real quality cultural change.

In general, to ensure a high probability of success,the cultural change must pass through several steps:configuration of the target culture and cultural change announcement;identification of target behaviors needed to achieve the new culture;training for managers in target behavioral practices;inclusion of practices in managers performance evaluation system ;including a reward system in order to stimulate the desired behaviors performance.[1]

In this purpose, the primary mechanisms recommended to convince employees of the need to introduce and implement a culture of quality are education, training and leadership, while the structure, systems and procedures are important, but secondary.

Rene T. Domingo stipulate that good intentions and sheer determination are not a guarantee of success in implementing total quality (TQ) in the company. TQ is a managed upheaval and its success cannot just come from raw enthusiasm of the participants - management and workers. To ensure a high success rate in implementing TQ, he suggest 7 steps or phases and advise to not proceed to the next step until the preceding one is completed, otherwise, the risk being to fall into a trap many companies have fallen into:[7]

- 1.Embrace a single quality philosophy;
  - 2.Management should lead and show quality leadership;
  - 3.Change or modify all systems and structures to suit total quality objectives;
  - 4.Train and empower all employees;
  - 5.Employees' behavior will change;
  - 6.Employees' develop total quality attitudes;
  7. A total quality corporate culture develops.
- If TQ is genuinely achieved,the organization

could expect that employees will become loyal to company and equate corporate success with personal success, will perform quality work because they believe in quality, will organize themselves voluntarily to do process improvement, without management intervention, pressure, or allurements and new employees, regardless of initial background and orientation, will easily adapt to the strong TQ corporate culture. QC circles, contrary to popular belief, is not necessary in achieving TQ. If they are nevertheless present, they should be a voluntary consequence of genuine dedication or commitment of employees to quality, and not a management directive. In conclusion, TQ must be implemented right the first time.[7]

What distinctly separates excellent companies from the mediocre ones is not the healthy bottom lines nor large enviable market shares, but a strong quality-oriented corporate culture that is shared by everybody- from the CEO and managers down to the lowly employee. This culture is reflected on everything the company has or does: quality products, quality services, quality facilities, and of course, quality people and management. The spread or extent of that culture does not stop inside the company; it goes downstream with quality vendors, suppliers, and subcontractors, and upstream with quality distributors, dealers, retailers, or franchisees.[8]

#### **4. Promoting a culture of quality in Romania**

Among the factors that increase the need for quality and performance in the Romanian economy may be mentioned: increasing competition; increase in the cost of key inputs increasing consumer demand due to the increase of the purchasing power,of awareness and education and diversity offers on market; legal regulations that set new standards for quality,environment and occupational safety; increasing market transparency thanks to the Internet and commodities exchanges; increasing consumer mobility; amplification of instability; access increasingly difficult to resources.[9]

In this context, Romanian corporate effort

to improve their ability to obtain quality and performance must be based on a series of principles such as strategic vision instead of short-term quality approach;management professionalization;promoting customer orientation;promoting a pro-quality culture in Romanian society;developing the capacity for innovation;developing strong quality brands;promoting an efficient management of knowledge based on the principle of lifelong learning.

Promoting a new culture of quality in the Romanian economy should take into account the trends concerning development of quality at international level[9]

The main function of the organizational culture is to give members of the organization both organizational identity and to generate a commitment to shared values and principles.

## 5. Conclusions

A quality-oriented corporate culture is the real TQC or Total Quality Culture, and not just Total Quality Control, which suggest something administrative, short-term, and imposed. TQC is not sustained by an executive memo nor promoted by compensation. It is a way of life resulting from everybody's sincere commitment to provide quality service to the customer and doing one's job right the first time and all other times. It is everybody's conviction that TQC is the only way to make the company survive indefinitely and stay competitive. Quality culture is not just a destination to be reached; it is, more importantly, a position or status to be maintained and sustained by repeating steps one to four - continuous review and preaching of the TQ philosophy, unwavering top management quality leadership, non-stop process and systems improvement, and continuous employee training, skills upgrade, and empowerment.

## 6. References

[1]Andrei,V., "Quality culture in the organization",  
<http://victorandrei.finantare.ro/2009/05/28/cultura-calitatii-in-organizatie/>

- [2] Avasilcăi, S.; Hutu, C. A.; Van der Wiele, A., "From quality assurance to organizational excellence" Ed.Economica, Bucuresti, 2001
- [3]Domingo,R.T., "The right steps to quality", Business Management Articles / Quality Management,  
<http://www.rtdonline.com/BMA/QM/6.html>
- [4]Domingo,R.T., " The need for quality-oriented corporate culture", Business Management Articles / QualityManagement,<http://www.rtdonline.com/BMA/QM/17.html>
- [5] Hutu.C., "Quality culture. Cultural Orientation impact on quality approach in rRomanian and strengthening the culture quality creation"  
[http://www.tulipnetwork.org.uk/Website%20linkend%20docs/Linked%20bibliog%20articles/RO-%20Uni%20articles%207.2008/ARTIC\\_1.pdf](http://www.tulipnetwork.org.uk/Website%20linkend%20docs/Linked%20bibliog%20articles/RO-%20Uni%20articles%207.2008/ARTIC_1.pdf)
- [6] Hutu.C., " Cultural change, competition. Case technology transfer in the Romanian companies", Ed.Economica. Bucuresti ,2003.
- [7] Moldoveanu, G., Dobrin, C., "Quality management in the public sector", ASE digital library,2015
- [8]Rosca,RD., "Quality culture"-soft of an organization capable of creating value for customers,  
[http://www.ecruvt.ro/conferinte\\_ecr/al\\_3\\_simpozion\\_ecr\\_ecr\\_academic\\_partnership/prezentari/14.30\\_14.45\\_rosca\\_remus.pdf](http://www.ecruvt.ro/conferinte_ecr/al_3_simpozion_ecr_ecr_academic_partnership/prezentari/14.30_14.45_rosca_remus.pdf)
- [9] Schein, E. H., „Organizational Culture and Leadership”,Third Edition. Wiley Publishers, New York, 2004.

## Aspects Concerning Quality in Tourism

Anca Cristina Stanciu  
„Ovidius” University of Constanta, Romania  
Faculty of Economics Sciences  
[castan22us@yahoo.com](mailto:castan22us@yahoo.com)

Mihaela Constandache,  
„Dimitrie Cantemir” Christian University of Bucharest, Faculty of Tourism and  
Commercial Management Constanta  
Constanta, Romania  
[mihaela\\_constandache@yahoo.com](mailto:mihaela_constandache@yahoo.com)

Daniela Simona Nenciu  
„Dimitrie Cantemir” Christian University of Bucharest, Faculty of Tourism and  
Commercial Management Constanta  
Constanta, Romania  
[nenciu75@yahoo.com](mailto:nenciu75@yahoo.com)

### Abstract

*Unlike the quality of products, quality of tourist services is difficult to define, to judge or expressed in quantitative terms, because the service has few physical dimensions, such as performance, functional features and maintenance costs, which could be used to compare or measurement. Quality of tourism should be approached as a market category, which means that it is a tourism product quality that makes the chain of tourism services. Knowledge of customer needs and the ability to provide consistent and useful tourist services are the result of managerial activities of tourism businesses and recruitment efforts, training and entrench the staff. These measures increase the credibility of the customer to suppliers and diminishes the quality of tourism services distrust. The quality of tourism product is ultimately reduced to the quality of the customer experience.*

**Key words:** quality,tourism,service.

**J.E.L. classification:** L83,M14,M29,P46

### 1. Introduction

In the context of the economy of knowledge have intensified concerns about quality assurance in all fields, especially in

the hospitality industry, given the specific quality in tourism.[1]

Delimitation of tourism product / service of other products presents a subjective impact on the quality, but the more important to consumers because it must meet its expectations. A product / service can provide a genuine tourism quality in itself. Also harmonization of tourism supply with natural and human environment is the basis of sustainable development, which implicitly involves ensuring a certain quality of tourism products and markets.

In the context of globalization tourist market and a business environment characterized by fierce competition, the center of gravity of the market is customer rather than product firms must change their way of thinking and acting, on the assumption that meet customer requirements is a necessary but not sufficient to achieve market performance.[8]

For a tourist company to offer its clients only quality services, it is necessary that before providing them, the tourist services should be completely and correctly aware of the clients' demands, and after their providing, it is important to learn as much as possible about their reactions (satisfaction or dissatisfaction).[4]

This paper aims to present the problems and the importance of quality in the field of tourism, and to take into account that the

satisfaction of the consumer or of the tourist highly depends on the quality of products and services offered.

## 2. Tourism service quality

Good service is vital to the success of any tourism business, and the first step to improving service quality is to make it a priority. Incorporating service quality into every part of a business - from the overall vision and strategy, to practical aspects like staff training, customer service and workplace systems and procedures - will keep the business competitive and help it to grow. In the guide issued by the Queensland Government on the business and industry portal there are indicated 9 steps in the toolkit to improve the business's service quality to be followed. Therefore, the tourism service quality toolkit proposed contains the following steps advised: [10]

Step 1: Write a vision statement for the business

Step 2: Develop a strategy for service quality

Step 3: Understand your customers' needs

Step 4: Hire staff that provide quality service

Step 5: Implement systems and standards for service quality

Step 6: Measure and manage service quality

Step 7: Recognise and reward service quality

Step 8: Review and revise service quality

Step 9: Service quality checklist.

The connection between tourism and quality experiences and quality of life has always been implied and assumed. A series of works demonstrates that multiple theoretical lenses can create a better understanding of quality tourism experiences than a single approach. The complexity of the topic is highlighted throughout many studies. [6]

Analysis of the implementation processes to provide tourism services allows highlighting the following essential aspects that will influence positively or negatively the quality of services:[2]

- a) processes providing tourism services have the character of commercial transactions;
- b) Due to their variability, the content of tourist services differ from one performance to another;
- c) Relationships between staff and clients are interactive relationships

and, consequently, the purchaser-express how it is perceived quality of service provided by both trading partners.

- d) In most cases the customer in a subjective quality benefits compared to other similar situations of consumption experienced in the past.

Thus, the customer perceives the quality not only technically but also in terms of functionality. In the consumer optics usually occur three levels of service quality assessment, grouped in order of evaluation difficulty:

-desired quality;

-experimental quality;

-credible quality.

According to this classification, customers pay more attention to the experimental and reliable quality services.[5] Thus can be distinguished different degrees of subjective quality assessment of tourism services:

-excellent services;

- good quality services;

-services qualitatively assessed as satisfactory;

-services qualitatively inadequate.

Cristian Grönroos distinguish these quality characteristics, assessed as determinant for the assessment of services process performance:[5]

-tangibility;

-reliability;

-responsiveness;

-assurance;

-empathy;

-recovery.

Of course, the significance and importance of these characteristics vary considerably from one situation to another, depending on the nature and size of temporal, spatial and structural characteristics of each service provided to customers. Defined like the probability that service will work properly in a programmed period of time and the conditions of use prescribed, in the case of tourism services reliability is a vital issue for the assessment of quality of performance.[5]

Therefore, ISO 9004-2 / 1994 recommends considering the following service features:[8]

-facilities (equipment), capacity, number of staff and materials;

-the waiting period, time of providing services, performance of the proceedings;  
-hygiene, security, reliability;  
-responsiveness, accessibility, courtesy, comfort, environmental aesthetics, competence, operational safety, accuracy, completeness, the technical credibility, effective communication.

Analysts studies have shown that consumer satisfaction is influenced by quality services, which in turn influence the buying intentions.

Therefore the solution to the problem of the service quality measurement is in fact determining how consumers evaluate the benefits received. Access to quality in tourism as a measurable category requires establishing quality criteria and tools for their quantification.

### 3. Quality- strategic option for tourism

Building proper touristic capacities and using proper business strategies in order to gain competitive advantage, the competitive edge in the harsh and competitive world of tourism is of crucial importance for all businesses that are engaged in tourism. Integrated in the marketing strategy, the product strategy establishes a series of objectives specific to this area as: the superior valuation of the of the tourist potential, attracting a larger number of local and foreign tourists, preventing season effects, consolidation of the position held on certain intern and extern markets, launching new tourist products, obtaining an increased competitiveness of the tourist product through an optimum balance between quality and price.[3]

Delivering quality service is one of the major challenges the tourism managers will be facing in the following years as it is an essential condition for success in the emerging, keenly competitive, global hospitality markets. There are various tools that measure and improve quality service, as well as mechanisms for quality recognition in the tourism and hospitality industry. The managers should identify, record and weigh up the impacts of cost-profit and be in a position to prioritise towards a quality improvement process for their own property.[7]

In today's fast moving environment a sound, well-advised strategic plan is essential for all businesses, none more so than those in the tourism industry. Without strategy, organizations are susceptible to strategic drift - a consequence of failure to monitor and respond to the changing external environment, a strategic plan covering:[9]

- analysis of external factors, including competition, economics and politics;
- choice and evaluation of the strategic plan;
- implementation, managing and monitoring the plan.

In the area of tourism, total quality management (TQM) is a participatory process that empowers all levels of employees to work in groups in order to establish guest service expectations and determine the best way to meet or exceed these expectations. In fact, the implementation of the quality management system is a kind of strategy that could be named the quality strategy. As companies came to recognize the broadscope of quality, the concept of total quality (TQ) emerged. Total Quality is a people-focused management system that aims at continual increase of customer satisfaction at continually lower real cost.

TQ is a total system approach (not a separate area or program) and an integral part of a high-level strategy; it works horizontally across functions and departments, involves all employees, top to bottom and extends backwards and forwards to include the supply chain and the customer chain. TQ stresses learning and adaptation to continual change as keys to organizational success.[7]

Diversification being the qualitative face of the development, we could consider the quality strategy a diversification strategy that implies the simultaneous development of new or improved tourist products and of the new markets (for instance, a tour operator specialized in the soft tourism can vary his mix of products offering also tourist tours with cultural character or treatment vacations in balnear resorts). This type of strategy allows the realization of a medium and long term flexibility of the derived tourist offer.[3]

In the meantime, it could be considered a tourism product renewal strategy that consist

of the increase of the activity without operating deep changes.

The effects of tourism on the environment have become an issue of growing concern internationally. A quality strategy in tourism should explore the central area of sustainability in tourism development. The relationship between environmental quality and tourism success is discussed, focusing on ways to protect the world's tourism destinations for future generations. Tourism's environmental impacts on the natural, built and cultural heritage and environments are central point in a quality strategy for touristic activities.

#### 4. Conclusions

The tourism sector is gaining increased importance for the economic development of countries around the world and the quality of touristic services is the central point of any analysis concerning this topic. Quality of tourism should be approached as a market category, which means that it is a tourism product quality that makes the chain of tourism services.

Quality is one of the categories that are not conceived from the perspective of the essential meaning because it is generally considered that everyone knows what the quality essentially is. In real terms, quality is the carefully managed, Quality Management being closely linked to the concept of continuous improvement, it does not take the form of capital -in the sense of an asset, but involves work to make something evolve, it is implemented within a reference framework, it uses tools and methods and involves repetition and evaluation. The quality of tourism product is ultimately reduced to the quality of the customer experience.

#### 5. References

- [1] Andrei, I., Numai despre calitatea serviciilor în turism,  
<http://www.ancheteonline.ro/2014/06/numai-despre-calitatea-serviciilor-in-turism/>
- [2] Balasoiu V., Dobanda E., Snak O., Quality management in tourism services , Ed. Orizonturi Universitare, Timisoara, 2003

- [3] Brikend, A., Nedelea, A., "Business strategies in tourism " , ECOFORUM [Volume 2, Issue 1(2), 2013],  
<http://www.ecoforumjournal.ro/index.php/eco/article/viewFile/21/12>
- [4] Butnaru, G.I., „The quality of services in tourism and in the romanian accommodation system”,  
[http://anale.feaa.uaic.ro/anale/resurse/21\\_M02\\_ButnaruG.pdf](http://anale.feaa.uaic.ro/anale/resurse/21_M02_ButnaruG.pdf)
- [5] Gronroos, C., "Service Management and Marketing: Customer Management in Service Competition " , 3rd Edition, John Wiley & Sons Ltd, UK, 2007
- [6] Jennings, G., Nickerson, N., "Quality Tourism Experiences", Butterworth Heinemann, 2005
- [7] Kapiki Alexander, S., "Quality Management in Tourism and Hospitality: an Exploratory Study among Tourism Stakeholders", International Journal of Economic Practices and Theories, Vol. 2, No. 2, 2012 (April),  
[http://www.academia.edu/1160667/Quality\\_Management\\_in\\_Tourism\\_and\\_Hospitality\\_a\\_n\\_Exploratory\\_Study\\_among\\_Tourism\\_Stakeholders](http://www.academia.edu/1160667/Quality_Management_in_Tourism_and_Hospitality_a_n_Exploratory_Study_among_Tourism_Stakeholders)
- [8] Milea (Rezeanu), O.M., Economic and social implications of services quality of Romanian tourism, Ed. Universitary, Bucuresti, 2011
- [9] Tribe, J., "Strategy for Tourism", Goodfellow Publishers, 2010
- [10] Tourism service quality toolkit/Queensland Government,  
<https://www.business.qld.gov.au/industry/tourism/service-quality-toolkit>



# The Loan in the Old Testament – Paradigm of the Contemporary Banking System

Adrian Vasile

Faculty of Orthodox Theology, "Ovidius" University – Constanța

[preotadrian@yahoo.com](mailto:preotadrian@yahoo.com)

## Abstract

*Usury is that kind of loan – of money or any other good – that brings interest. Nowadays, usury and interest have come to be defined in different ways. Unlike interest, which in time has earned its legal status, usury is considered to be an excessive interest demanded by those who lend money outside the legal framework. For us Christians, usury is one and the same thing, representing a sin based upon love for money (a deadly sin) and upon lack of mercy for the misfortune of our brother. The Holy Tradition clearly condemns lending and charging an excessive interest and sees it as stealing consented by the victim.*

**Key words:** loan, interest, usury, the Old Testament, Talmud

## 1. Introduction

We all experience borrowing as something natural, ordinary, regardless of the fact that it may be from people we know, mutual aid funds, or banks. We live in a period when buying with your ID card or withdrawing money with your credit card are ordinary activities of the modern man. For all these activities the modern man has to pay a form of interest, commission or tax to the bank, and that makes it necessary to go back to the roots of this phenomenon to see how it was perceived in the Mosaic Law and later on in the rabbies' views.

To „lend to a man in need is an act of love and kindness towards your fellowmen". The biblical text is full of advice and blessings for those who „lend for free" to those in need.

Indeed, the interest-free loan seems to be essential for the welfare system in the Old Testament. It is the duty of the relatives to

lend to their relatives who are in need and to redeem them from debt. Therefore, to be in debt *per se* is not something evil or sinful. The debt could have appeared as a result of misfortune or of unjust judgment. No matter what the cause was, it was a blessing for those who would lend a hand without asking for interest. Jesus Christ made this challenge an even more radical one for His disciples urging them to lend even to their enemies „without expecting the loan to be paid", which primarily means not to insist upon getting back the money or upon a mutual gain.

## 2. Loan in the Mosaic Law

In the law of the Old Testament there are several precepts and rules regarding loaning money by the Jews. Initially, Moses ruled out getting usury from the poor exclusively, as it is stated in the text: „If you lend money to one of my people among you who is needy, do not treat it like a business deal; charge no interest". (Exodus 22, 25) or „ Do not take interest or any profit from them, but fear your God, so that they may continue to live among you. I am the Lord your God". (Leviticus 25, 36). Later on there were debates upon who is to be considered poor, and they have decided not to take interest from co-nationals, be them poor or rich [1].

On the one hand, in the Old Testament, the loan is seen as a good deed when it was given without charging interest or usury. This phenomenon appeared when the poor were lent money in order to protect them from greedier lenders, generally belonging to other nations. Moses' law had clear prescripts that imposed the obligation to lend without asking for interest or usury: „You may charge a foreigner interest, but not a fellow Israelite, so that the Lord your God may bless you in everything you put your hand to in the land

you are entering to possess. (Deuteronomy 23, 20). In the same line, the psalmist praises the one who lends without charging interest: „He provides food for those who fear him; he remembers his covenant forever”. (Psalm 111, 5).

On the other hand, as we have seen in Deuteronomy 23, 20, the interest-free loan is granted to those of the same nation, since the Law recommends charging interest to the foreigner as it was the custom with all neighboring nations.

In case the lender lent an important sum of money, to make sure his debtor had good faith, he had the legal right to take gage or security (*erabon* in Hebrew). There were some legal percepts regarding this issue as well. One such percept was that the lender was not to enter the debtor's house and take what he wanted, but to wait in front of the door for the debtor to bring him the object that he did not actually need.

And so we read about Judah who gave Tamar his signet ring, cord and staff as security for the young goat he promised her (Genesis 38, 17-18). After repaying his debt, the creditor had to return the gage, regardless of its value (Ezekiel 18, 12) [2]. The debtor was exempted from paying his debt in Sabbatical years, since not working the land meant he had no income. The debt was postponed until the following year. When no object was given as security for the borrowed sum of money, often the debtor and his family would go and serve the creditor until the debt was paid. (Deuteronomy 15, 12; Leviticus 25, 39). The necessary objects of the poor household, such as the grinder or the tent (*simla*) that served as shelter for the night, could not be taken for more than a day [3]. The Mosaic Law compelled the creditor to return these objects by sunset.

As far as the interest was concerned, in the Old Testament there are two kinds of interest: *Nešeh*, which was the interest paid for the borrowed money and *Marbit* for borrowing food, corn, and other such things, which had to be returned in a larger quantity.

After the exile, the debtor certifies, most often in writing, that he has been lent money. I. Hejcl thinks that this law on interest and usury was given after Moses' times. The text in Exodus 22, 25 establishes only general rules and refers only to money lent to someone. But, in Moses' times, when lending

money to the poor could not have been so wide-spread, there is no doubt about the poor lending money quite rarely.

Deuteronomy 23, 20 is much clearer than Exodus 22, 25, which led to believing that it was formulated later on, since Leviticus 25, 36 might have been written after the exile or even before it, shortly before the destruction of the kingdom.

In general, we can consider that this rule forbidding charging interest from those who were part of the same nation was not something fair. But, in the social and economical context of the Old Testament, each Israelite had his own land that he could not sell. So, the rich, though they possessed lots of money, could not buy land to give them annual revenue, and, since the Mosaic Law was not favorable to trading, possessing lots of gold and silver was useless. That is why he who would lend to his co-nationals without charging interest had nothing to lose. Seldom would the debtor suffer any loss, since each debtor had his own land and the creditor could get part of the harvest of that land to cover his loss.

We must mention the fact that Egyptians used to lend money without charging interest as well. But this does not mean that Moses' command as not to lend money for interest was borrowed from the Egyptians. Even the Babylonians, through article 48 in Hammurabi's Law had a prescript which did not recommend lending for interest. Yet, we cannot say that Moses got the idea from Babylonian laws, for, even though the Babylonians are a much older people than the Israelites, what is settled by Babylonian laws regarding the loan is much recent than Moses' writings [4].

In Neemia's book, chapter 5, there is a story of someone who took advantage of people's misfortune. Neemia and his brothers and servants, all kind-hearted men, after returning to rebuild Jerusalem, paid lots of their money to redeem their brothers from slavery from the peoples around. Brought back to the country, they got fields and houses, but apparently they were not able to work them properly and they starved. So they went to their brothers who had got there earlier and had managed to make a certain fortune and asked for wheat. But, contrary to God's Law, their brothers asked them to gage their fields, houses, and vineyards. Moreover,

those who had been freed from slavery also had to pay the emperor in silver and had no way to do so. They went back to their brothers to lend money, and their brothers asked for a 1% interest, which was forbidden by Moses' law. When Neemia found out about this, he gathered the people and reprimanded those who took advantage of their brothers' misfortune, for they had enslaved their brothers by making them unable to pay back the money and to make an economic recovery since they had been taken their income sources – the fields and the vineyards. Neemia reminded them how his brothers and he had spent so much to redeem them from slavery. Then he pointed out that while he was their ruler he got no salary, though he had to feed 150 people every day, which was a great financial burden for him. All the people who stood at his table were working for the public service, but Neemia would offer them the meal from his own resources. And he did so because he wanted to be able to ease the pain of the people. He then mentioned the fact that in all that period he had not purchased any field from anyone, because he was not after increasing his wealth at the expense of his brothers' misfortune, but he tried to do them good and help them from a financial and economic point of view. This story in the Holy Scripture emphasizes God's commandment through Moses as not to charge interest or usury from your fellow citizens. [5].

In his comment on Psalm 14, Saint Basil the Great speaks clearly of loans and interests and usury, pointing out the right approach of the Christians towards them: "Are you rich? Do not borrow money! Are you poor? Do not borrow money! If you are rich you have no reason to borrow money, and if you have nothing, you won't be able to pay back the loan. (...) You had better ease your needs slowly, wisely, rather than get rid of them at once by means of foreign money, and later on lose your whole wealth. (...) If the person who lends you money is your friend, try not to lose his friendship! If he is your enemy, try not to fall into his hands! You enjoy foreign things for a short while, but later you will lose the wealth you have inherited from your parents. Now you are poor, but you are free! Once you borrow money, not only will you not be rich, but you will also lose your freedom. The one who borrows is the slave

of the lender". [6].

### 3. Loan in the Talmud

The rabbies distinguished four categories of contracts: free loan, simple loan, reward loan and renting. He who gets a free loan swears in all cases (in case the object has been lost or stolen) and does not pay for it. He who gets a reward loan and he who rents an object swear when it comes to an animal that has been injured, kidnapped or killed (and they do not have to pay for it); they pay for it if it gets lost or stolen.

This general principle is amplified by the *Baba mezia* treaty, which examines different such cases. If someone gives an animal or an object to a close person (who swears to take care of it without payment) and if the animal or object gets lost or stolen, the borrower can choose to pay and refuses to swear, according to the principle: he who borrows freely swears and is not responsible, but later on if the thief is discovered, this one will have to pay double; but if he who borrows freely killed or sold the animal, he will pay four or five times.

If two persons lend money to a third party, the first one lending a *mana*, and the second two hundred *zuz*, then each of them asks for the larger amount, the benefactor gives them each a hundred *zuz*, and keeps the rest until

Elijah comes (in popular belief Elijah solves all controversial issues). **Rabi Jose** says: if things go like this, then what has the impostor lost by making a complaint? He lost everything since it has to be kept until the coming of Elijah [7].

If someone gives money to a close person (freely) and the person wraps it in a bundle and puts it around his shoulders or leaves it in the hands of his underage child, or does not wrap it properly, he is responsible for not safely keeping the money he was given; if he keeps it properly, he is not responsible.

If someone gives a deposit of money which is wrapped to a person who changes money, the person who receives it cannot use it; but he is not responsible in case of losing it. If the amount of money was delivered in separate units, then he can use them but is responsible in case of loss. But if it is not a person who changes money, but an ordinary person, he is not to use this money whether it

has been wrapped or not, he is not authorized to use it and is not responsible for its loss.

Here are some rules for a renter: if a person rents a donkey to take him up a hill and it takes him into a valley or the other way around, and the distance is the same, and the donkey dies, there is responsibility. If a person rents a donkey that loses its sight or is confiscated by the government, the owner can say: "This is what belongs to you"; if the donkey is injured or dies, the owner has to provide another one to the person who has rented the initial donkey. If the person rents a donkey to take him up a hill and it takes him into a valley and the animal runs away, there is no responsibility; if it gets exhausted, there is responsibility. If the person rents a donkey to take him into a valley and it takes him up a hill, things go the opposite way, but if the animal gets exhausted, there is responsibility.

If a person gives another person a sum of money as gage, it is a reward loan. But **Rabi Yehudah** says: „If there is money, the contract is free, if there is fruit, then it is a reward loan” [8]. Here is what the loan was about: if a person rents a cow, he also rents the services of the owner of the cow. Or if he has firstly rented the services of the owner and then rented the cow, in case the animal dies, the lender is not responsible because: „If its owner was there, there is no payment. And if it was rented for money, the rent is to be accounted for.” (Exodus 22, 15). But if he firstly rented the cow and then the services of the owner, and the animal dies, the lender is responsible because: „If someone rents a cow and it gets injured or killed and its owner is not there with it, the person must pay for it” (Exodus 22, 14).

#### 4. Conclusions

As we have seen, God allowed the Israelites to lend to foreigners and charge interest to foreigners, meaning to those who were not part of the people of Israel. In fact, money is meant to be invested and make more money, and if anyone should choose to invest by borrowing, it is their choice, but they shall not make such investment by taking advantage on anyone's misfortune. The Holy Scripture teaches us to love the person next to us and do them good. When our Lord Jesus Christ was asked who the person next to us is, He told them the parable

of the Good Samaritan so that no matter who needs our help and we can help them, we should do so. Also, in the Epistle for the Galatians it is written: „Let us not become weary in doing good, for all the proper time we will reap a harvest if we do not give up. Therefore, as have opportunity, let us do good to all people, especially to those who belong to the family of believers (Galatians 6:9-10).

In the Old Testament, the money changers or exchangers were people who borrowed money and returned it and paid a certain interest. They would in turn lend this money to others and charge interest. This was their business borrowing and lending money. It is exactly what the banks do nowadays as a business. In Jesus Christ's parable of the Talents (Mathew 25:26-27), the practice of the money changers to charge interest was not condemned, on the contrary, it was suggested to the one who did not want to use his mind and profitably invest money in order to get a better profit.

Financial aggression is the most subtle and productive weapon of our times. Today, rich countries subject and control poor countries by offering them tempting loans so that they stay forever in debt. From this perspective we can understand why the Christian belief, based upon unconditional help and limited material needs, is so disdained by those who wish to rule the world, politically and economically.

From a legal point of view, „usury” is defined as a new „crime” (breaking of the law), though its roots go back a long time. According to the law, to be punishable, the „money lender” must have done so repeatedly and must have charged a certain interest each and every time.

Law no. 216 adopted by the Romanian Parliament and published in the „Official Journal” on November 22, 2011 bans „usury”, meaning „lending money as a job by an unauthorized person”. So the difference between a banker and a money lender is that the first one has an „authorization”.

#### 9. References

- [1] Abrudan, Pr. Prof. Dr. Dumitru; Cornișescu, Pr. Prof. Dr. Emilian, *Arheologie biblică*, Editura Institutului Biblic și de Misiune al BOR, Sibiu, 2002, p. 156

- [2] Clement Alexandrinul, *Pedagogul*, în PSB, vol. IV, Editura Institutului Biblic și de Misiune al BOR, București, 1982, p. 221
- [3] Semen, Conf. Dr. Pr. Petre, *Arheologia biblică în actualitate*, Editura Mitropoliei Moldovei și Sucevei, Iași, 1997, p. 127
- [4] Tarnavschi, Vasile, *Arheologie Biblică*, Editura Consiliului Eparhial Ortodox al Bucovinei Tiparul Glasul Bucovinei, Cernăuți, 1930, pp. 348-349
- [5] Travis, Charlotte, *A Study of Ezra and Nehemiah*, Cross Books, Bloomington, IN, 2011, p. 81
- [6] Sfântul Vasile cel Mare, *Omilia a II-a la o parte din Psalmul XIV*, Editura Institutului Biblic și de misiune al Bisericii Ortodoxe Române, București, 1986, p. 216
- [7] Epstein, Isidore, *The Babylonian Talmud*, Soncino Press, London, 1935, p. 224
- [8] Goldwurm, Hersh, *Talmud Bavli*, vol. IV, Mesorah Publications, New York, 2002, p. 13

## Eco-theology – Church’s Solution on Humankind’s Environmental Issues

Costin Vasile

*Department of Theology, Ovidius University of Constanța*  
[vasilecosty@yahoo.com](mailto:vasilecosty@yahoo.com)

### Abstract

*The entire Creation is today, more than ever, dealing with many issues to whose solving all people are summoned to contribute by their devotion, including Christians and the Church. The consequences of certain actions of the human have progressively deteriorated the environment and, implicitly, the quality of life.*

**Key words:** eco-theology, the Church, matter, creation, Earth, man.

### 1. Introduction

The world was created by God from nothing, by the power of His word. And if God created the world according to His eternal plan, certainly it contains the purpose for which it was created, which is double: it concerns both the Creator and the creation. From the Creator’s point of view, the world was created so that God will manifest His perfections and also His almightiness, His kindness and His love. From the creation’s point of view, God willed to share with it His kindnesses, conceding rational creatures and especially man with good and happiness.

“Every living thing created is good, and this goodness should not be altered, but sustained and mastered for God’s face to be shown in it. The synthesis of all perfections is the human, the crown of the divine faith, and for this reason he must take great care of the keeping of the creation’s integrity. If the world turned out good from the hands of the Builder, the man must keep its quality, guard it from damage, preserve the world which they should take into account.”[1]

The man is created after God’s face and, therefore, has a unique relationship with God

and the nature, reason why The Holy Bible presents to us the human-nature relationship as an anthropocentric one. The man is presented in the first pages of the “Genesis” book always in the nature, the man never being presented outside the nature and neither stripped of his ruling over it. Talking about the face of God in the man, Saint Grigorie Palama shows that it consists of the quality of “ruler ( *ἀρχων* ) of the world”. [2]

### 2. The unity and integrity of the creation

Although the world was created before the human, only through him it receives the absolute reality and it acquires its “destiny of being congregated in the man and humanized” [3]. The man, who is a collaborator of God and a pursuer of creation, is also the priest and master of the Universe. Also, he must be an intermediary between the Creator and the irrational beings and the prophet that ushers through word and act the will of God. This dignity of man is fundamented on the fact that he is “the face and the praise of God” ( I Cor. 11,7). „The edenic unity and harmony are shown to us as an existing reality, firstly in the psycho-physical construction of man, and secondly in the relationships between the human and the material world governed by him” [4]. Creation’s unity and integrity refers to the fact that salvation is not a state exclusively for man, salvation doesn’t apply just to water or animals, but to the entire creation, with all its components and the man is responsible not only for his own salvation, but also for the universal one.

Unaccomplished by man because he lapsed, his “mediator of the universal

divisions in a synthetical unity" [5] destiny was accomplished fully and exemplary by Jesus Christ in His iconomy, and in Christ it can and must be realized now by everyone who believes in Him. The world was created for Christ, who is and remains the only Ruler of universal unity and integrity.

### **3. The matter – object of love of God and man**

There isn't anything that doesn't have the imprint of love of God. When someone truly loves, he lives in time some of the eternity; as long as the man loves someone, he wishes that that subject of love to live eternally. Through extrapolation, we would say that if someone loves the nature, he helps it become eternal. They talk a lot about the safe-guard of the creation, they search for ways and methods. What would be the reason for which something must be saved? The answer is singular: love, because you can not salvage something you do not love.

"The man has the calling of being king of creation". A good king is the one who loves his subdues, otherwise, sooner or later, they riot against their ruler. "The man-king" didn't get the calling to subdue the nature through humiliation or to satisfy selfish wishes. Ruling the world means leading it to God, not reclaiming it for himself. The ruling assumes moral and spiritual transformation, which is guided firstly to himself.

The man is called to also be priest of the creation, meaning to be sacrifice, to purify and offer to consecration all that is material. He speaks to God for all creatures."[6]

### **4. Life-giving Earth**

At the genesis, the Earth was given the power of coming to being the

wonders of life and beauty like the billions of creatures, scents, colors, forms (Genesis 1:11). He who built the basic element of human's corporality, he is treated as "someone" who God endows with gifts, because gifts are given to "someone".

Through the building of man out of dust with the hands of God, the dust becomes interior to the human being. The man is dust in the most literal meaning of the word, to which he is connected by his imoral way. But he is more when we ascertain that he is in constant activity: work, food, knowledge, contemplation, dedication, science. Knowing the earth the man knows himself, because it is the corporal self, forming a whole with the entire Universe. So the earth "evolves" once with the human through love and respect. The man and the earts were created to exist and minister reciprocally, to transfigure through gift. Any major event in humanity's life has involved its environment.

### **5. The ecological crisis or the suffering of the Earth**

The ecological issue in not just a fashionable subject in theology and technology as long as the effects of the unconditional exploitment of Earth's resources are visible and dramatic. Water pollution, the depletion of unrecoverable resources, the destruction of the ozone layer, the unprecedented rise of nuclear radiation, the desertification of extended areas do not represent accidents anymore, but actually unnatural conditions that inflict suffering on the Earth, and indirectly on the human. The Earth, on which by God's will was meant to grow vegetation, starts draining because of human's actions.

Science and technology are God-given gifts which apply on Earth. Used abusively by humans, thet lead him to slow death,and so the modern culture is rightly named "death culture". The voices

of those which propose a controlled development, programmed and fair, a more balanced distribution of good, to a balanced lifestyle are either ignored or suppressed, because science has been enslaved to economy. Biotechnology and genetic engineering cannot be rejected because they can bring new things in the fight for life, if they are approached in the light of the Holy Spirit because, in the absence of a true knowledge of the transcendental vocation and of the mankind spiritual nature, the new techniques can lead to biological unbalance which results in disastrous mutations for life existence. The human creativity and freedom are positive as long as they are rooted in divine wisdom.

„The problem of the modern man is that we have a pathological wish to be autonomous from God. Man created his own century culture whose ideal is to subject nature to his selfish purposes. It is important to see how the mankind in its 80000 years of terrestrial existence did not alter environment so irreversibly like the last 200 years of industrial development. The centennial culture confused transcendence with God's absence from creation. To the secularized culture have also rallied certain theologies that have radically separated the natural from the supernatural, confusing the transcendence with the absence of God from creation, right before the instauration of the Enlightenment's values.”.[7]

## **6. Eco-theology as social attitude**

The true and faithful christian must see the world as his own home and each person as his own brother or sister, which God loves. The change of attitude begins with a change in mentality by understanding that „the belief in the autonomy of creation must be overpassed and the antinomic statement of both God's transcendence to creation and His immanence in it.”[8]

The orthodoxy is an important drive in the matter of environmental education through the teaching about divine energies, present in creatios and through the eschatological destiny of the matter.

It is not easy for the christian, modest, reduced to necessities, without extravaganzas lifestyle to be proposed, after the model of the Fathers of Church. Nevertheless, the care for the conservation of the creation must be a constant impulse transmitted to the christians to exercise discipline, spiritual renewal fit for a christian life, disregarding each person's social status.

The education for human's dignity, unilaterally promoted in every political, social, economical, theological circle must be complemented with education for life itself, as long as “it cannot be talked about man's history without talking about universe's”.[9]

Christianity recommends balance in everything because it doesn't see goods purchasing as a vocation, like the modern man. Nature is the means through which the man can access eternal life.

The monasticism represents the rough side of caring for the environment, parallel with aiming the attention to God and spiritual growth. Besides strengthening of the will and practicing discipline, the monahal abstinence is a sign of respect for the creation which he doesn't exploit excessively; he only takes what the nature gives.

The ecological crisis, if it can still be attenuated, finds in the monastic model an ally. It implies mans will of self-limitation in consume and possessions, not only of food, but of any consumme that exhaustes unrecoverable resources. The authentic distinction between desiring and needing is essential, because it coordinates the relationship between selfish desires and natural needs. Man's place in the universe is understood only when he has the power of saying “no” to all that defines sin.



## 7. Conclusions

In other words, man alone cannot determine either the end or the salvation of the planet, but he can turn to God to recognize his reasoning, kindness and love of people, trying to follow His will and plan in the name of the being, respecting his dignity as priest, servant and king of creation. Parallel to the politic and social decisions of the European bodies, the church must play an important role in education for the safekeeping and the transfiguration of the matter as it has done in its millenary tradition. The well-known notion of symphony from the bizantine tradition shouldn't be restricted to the relationship church-state but extended to the level of the church-universe relationship.

The church, in its quality of divine-human institution is called to assume its formative and educational role:

a) prophetically, it should voice the realities of the faith and to make clear God's message as the most important tool which forms a certain attitude towards creation, also showing its destiny;

b) educationally, it should teach the believers to apply in their personal lives the concern for what we have as a gift, giving more importance to those which would come and who have the same right to a healthy life;

c) communicatively, the church is called to create a connection among school, family, parish, non-governmental organisations, foundations and generally speaking among people with common interests.

The model of education for balance, so specific to Orthodoxy, which uses fasting as a way to strengthen a person's will, which preaches concern for the soul and consumption limitation in favour of generosity and communality must be extended

The new european context can be used to grant support to some monastical communities in practicing a durable

agriculture, by producing organic food. Equally, it can promote education through pilgrimages, respectively by changing the touristical mentality to a more attentive care for the religious care and nature, and also by cultivating the respect for and the importance of the Housel in the everyday life.

The religious education is meant to adjust and introduce in the classical thematic newer aspects of the creation theology, not only in the sense of the origin of our Godly existence, but also in the sense of the responsibility of man towards the created world, in the perspective of change.

Not the apocalyptical panic is the characteristic property of the true faith, because the centuries are in God's hands.

## 8. Referances

- [1] Remus Pr.Dr. Onișor ,Unitatea și integritatea creației în scrierile Sfântului Apostol Pavel, în Studii Teologice, seria II, anul XLI, nr 4, iulie-august, 1989, p. 38
- [2] Isidor Pr.Prof. Todoran, Starea paradisiacă a omului și cea de după cădere în concepțiile ortodoxă-romano-catolică și protestantă, în Ortodoxia, VII (1995), nr. 1, p. 29
- [3] Dumitru Pr.Prof.. Stăniloae, Chipul lui Dumnezeu și responsabilitatea lui în lume, în Ortodoxia, XXV (1973), nr. 3, p.347
- [4] Sf. Ioan Gură de Aur, Omilia IX, 4 la Facere, în P.G. Tom. LIII, col. 79, în Studii Teologice, Pr. dtd. Remus Onișor, Unitatea și integritatea creației în scrierile Sfântului Apostol Pavel, seria II, anul XLI, nr.4, iulie - august, 1989, p. 39
- [5] Constantin Arhid. Prof. Dr. Voicu, Histrologia cosmică după Sfântul Maxim Mărturisitorul, în S.T., seria II, Anul XLI, nr 4, iulie – august, 1989, p. 14
- [6] Petre Pr. Prof. Dr. Semen, Concepția biblică despre proprietatea asupra pământului, în Teologie și Viață, nr. I., 1997, p.25-26.
- [7] Dumitru Pr. Prof. Dr. Popescu, Toward an Orthodox Ecological Education: Theological and Spiritual Principles, manuscris, p. 3, apud Lucian Festeleu , Terapie prin creație-considerații ecoteologice despre natură și psihic, Lucrare de Disertație susținută la Facultatea de Teologie Ortodoxă din Alba-Iulia, specializarea Consiliere Pastorală, 2009,pag 31

- [8] Dumitru Pr. Prof. Popescu, Ortodoxie si contemporaneitate, Editura Diogene Bucuresti 1996, pg. 3  
[9] Ibidem,p. 4.

*This work was supported by the project "Sustainable performance in doctoral and post-doctoral research - PERFORM" co-funded from the European Social Fund through the Development of Human Resources Operational Programme 2007-2013, contract no.POSDRU/159/1.5/S/138963*

# The Secularization of the Contemporary Society and Holy Church's Attitude Toward This Phenomenon

Costin Vasile

Department of Theology, Ovidius University of Constanța

[vasilecosty@yahoo.com](mailto:vasilecosty@yahoo.com)

## Abstract

*The left-aside phenomenon of the Church was accompanied by the secularization process in the spiritual field and is one of the most dangerous enemies of religious life. Through secularization in the spiritual field, man ties tighter and tighter to the material world and is exposed to the total alienation process related to the religious values, meaning the Christian teaching which places him in a relationship with God and only starting with this relationship man's ratio with the created world is falling into measure.*

**Key words:** secularization, transcendence, immanence, autonomy, creation, spiritualization.

## 1. Introduction

“The way in which the Holy Trinity was understood in the Eastern Theology has decisively influenced the conception about the Church and the world. The Divine Nature being unilaterally accentuated to the detriment of the Trinity, it has come to a Trinity closed in Itself, isolated in Its inaccessible transcendence, fact that implies the risk of being felt without interest for the religious existence. Therefore, a radical separation between “the natural order” and “the supernatural” one is made, without taking into consideration the internal link between them. God's transcendence has come to being confused with His absence from the creation. And if God isn't present anymore in the world and doesn't influence it anymore in any way, it becomes an autonomous reality.” [1]

The Enlightenment Age has modified the direction which the creation had in the

Eastern Theology, transforming it in an autonomy which denies God's existence and His Creator and Praiser qualities. Furthermore, it has been concluded that “any intervention of the supernatural order in the natural order is a violation of it, therefore this being the basis of the secularization process, which confined the human in his own immanesced sufficiency, with its whole suite of negative consequences on his moral life.” [2]

The French Revolution is that historical moment when the Laic Atheist State or religiously indifferent imposes itself in Europe, in which the Church is separated from the State or left-aside, therefore slowly excluded from all branches of political activity.

## 2. The theological implications of secularization

“The worst thing is that to this cultural implication has also been inevitably added a theological implication. Looking at it in its atheist meaning, the secularization isolates the Divinity in the transcendent and it attributes to the knowledge of God a simple intellectual dimension, letting aside its moral and spiritual implications on the entire human being, both on the soul and the body.

Therefore, knowing God becomes a theoretical and speculative issue that people don't take interest in anymore.” [3] Under any of the forms that this more and more accentuated secularization has manifested, they have promoted the rupture between theory and life, spirit and matter, contributing to the advertisement of the secularization process which touched the contemporary Christianity. Knowing God has become strictly an intellectual issue, without moral and spiritual consequences in the believer's

lives, contributing to society's secularization process.

"The urbanization represents one of the keys to interpreting the secularization. The evolution of the urban civilization and the destruction of the traditional religious values are the two marking phenomena of our time and are tightly connected to each other. The world needs less and less the religious standards to sustain its morality. To some, the religion is a preoccupation during vacations, to others is a sign of the national or ethnical affiliation, and for others is an aesthetical satisfaction. There are some other persons who believe that the modern era has its secular religions, its political saints and its unholy temples. The world has become man's primordial duty and responsibility. The man has become cosmopolite, the world has become his kingdom, and the kingdom became the world".[4]

"Going further in the same direction, we can say that both the isolation of God in transcendence and creation's autonomy from its creator have determined man to take the place of God on Earth and rule the world in the name of the Creator. As sustaining ideas to this thesis, two biblical realities are brought, namely one in the human being has in it the face of God, which allowed man to substitute the Creator on Earth, and the other in which the man was commanded to rule the nature, which was transformed in a religious justification for his own interests. Through this command the man has understood that he is asked to impose to the world his own order, by his desire." [5] "Therefore, the nature loses its creation quality of gift from God, of expression of the divine love of man, becoming simply an object of analysis." [6] This approach on existential issues has imposed the idea that there are no boundaries for man. He can see the world and daringly overpower it. Through the progress of the science and the technique, the man has begun manipulating and exploiting the material world without purposefulness.

Therefore the man isn't the one who must adapt to the created nature, but he is the one who imposes to the nature the way it must mould according to what he believes to be right. This forced molding of nature has backfired on the man many times, even if it also contributed to his well-being (example: ecological crisis).

All these progresses of the mankind made the people arise the trust in their own forces, beginning to think that maybe this God worshipped for thousands of years isn't in them.

Therefore the original sin of the man, of being God is starting to fall again into place in the modern world. A Romanian Orthodox theologian, referring to reason's autonomy as a result of creation's autonomy says as conclusively as possible: "I do not believe in the power of the human reason. The modern concept of reason's autonomy comes from the pagan humanism, that is the unlimited trust in the power of the individual of rising above the world, forming and dictating his own laws. It is an attitude of high-mindedness which infinitely reproduces and consecrates Adam's sin, fallen through conceitedness when he is drunken with the illusion of ascension through his own nature. The world before Christ believed in this autonomy; the modern world, divorced of Christ, has come back to it, re-engaging with the sin all over again." [7]

There are some voices that insistently ask the Church to keep up with the culture of the present time and to modernize itself, become more active and respond to the expectations coming from the secularized society.

But modernity has transferred the center of gravity of the world from God to the man, hence the man feels so autonomous from the Divinity, that he deems God's will an attempt on his own freedom. Therefore the sacred becomes the main obstacle in the way of his freedom.

### **3. Church's attitude toward secularization**

"To overcome this phenomenon, the Church must affirm the presence of God in the creation, because God remains both transcendent to the creation because He is not created, and also present in creation through His uncreated work. God's presence in the creation is important both for the overcoming of the world's autonomy from God, and for emphasizing the eschatological purpose of the creation, because the world wasn't built to be profaned by man." [8]

In the front of all the dangers arisen because of this desacralisation process, the Church cannot and must not remain careless,

but it must fight with all the weapons it disposes of to reinvigorate the spiritual life of the Christian communities.

"Confronted with these fundamental issues, the Christian theology in general and the Orthodox in particular, has expressed its point of view in the context of the ecumenical movement which granted to the God – man – creation relationship a special importance. Therefore, Orthodoxy has set in the center of its ecumenical concerns the teaching of the Holy Trinity, and especially the correspondence between theology and the "iconomie", to avoid the separation between supernatural and natural. Hence the orthodox theologians have sustained not only that the trinitary dogma should be explicitly included in the theological basis of the Ecumenical Council, but also that the personal-hypostatical interpretation to be applied to the Ecclesiology." [9]

"We are in a fight with the forces that conduct our economical, scientific, social, philosophical and theological systems, which are frequently developing blindly when it comes to Earth and nature, the feeding mother of the entire humanity, life and culture. We believe that only the image of the universal Christ will help us rediscover the entirety of the Earth, of the universe created in Him, through Him and for Him. Maybe we will also get to embrace the Earth with our arms spread like Christ, on cross's wood. A universal hug, through the universal Christ." [10]

In the patristic cosmology (Saint Irineu, Saint Atanasie cel Mare, Saint Vasile cel Mare, Saint Maxim Marturisorul), God is transcendent to the world through His being, but is present in creation through His unmade energies which springs from the divine being. Therefore, the thinking of the fathers overcomes both the pantheist cosmology through the affirmation of God's transcendence on the world, but also the autonomous theology, by affirming the presence of God in the world. With this approach, the secularization cannot find a justification anymore, because the presence of God in the world and the possibility of the transfiguration of it through Christ and the Holy Spirit in the Church by the will of Father God is affirmed. By the continual creation concept, the Holy Fathers are putting the beginning of the world in the creation

from nothing and completing it in the new sky and the new Earth through Christ as Creator and Messiah.

"The world must not be reduced exclusively at its material dimension because it also has a profound spiritual signification through its internal rationality, which has its spring in the supreme reason of the divine Logos. This rationality of the creation with the center of gravity in Logos, offers us the opportunity to overcome the separation between man and nature. Harboring in itself the entire creation, the man can go forward together with it toward God, as a connecting "ring" between the seen world and the unseen." [11]

The social and cultural realities of the human life are dominated. The everyday values of the urban life cannot be ignored, because they deeply affect the modern man, both his body and his soul.

In this direction, the weapons with which the Church can prevent the expansion of this dangerous rod take hold of the practical domain. "Therefore, the accentuation of the Catechumenal Bible has an important role, especially through its central piece, the reading of the Holy Bible. Also, the believer's catechization through the cognizance of the Christian values is indispensable in today's society. Every believer must become at the same time an apostle of Christ, expand the Church through participating to the Holy Mass, as a starting point for their mission." [12]

The Church has a continuous fight to take against this rod of the contemporary world. We have the duty to build new worshipping places to multiply the parochial communities and so that their beneficial influence to be more evident. The lack of worshipping places makes the believers live a more individual life than a communitarian one, to disperse to different churches, hence losing the meaning of the mutual connection and communion.

Also, "for the spiritual and moral rebirth of the society, orthodox organizations with a higher number of believers are needed. Organizations of the orthodox youth, of the orthodox intellectuals or politicians who will sustain Church's point of view in spiritual or moral matters with which the contemporary society is dealing with are needed." [13]

The Church must keep good relationship with the State because they must work

together for the good and progress of the society we live in.

The authentic Christian spirituality is the only solution against secularization, because it proposes the fight against the intemperances, as irrational movements that inevitably lead to spiritual crisis. Saint Maxim Marturisorul says "God didn't create with the man neither the pleasure, nor the pain in the feels, but gave the mind a certain capacity of pleasure so that he will confidentially enjoy Him. This capacity, which is the natural desire of the mind after God, the first man binding it exclusively to the material feeling, and he saw the pleasure moving against the nature, to sensitive stuff through the conveyance of the senses." [14] But his continual pleasure carries on the positive original element and it depends on the man to turn it's move back to it's real good, towards God.

#### 4. Conclusions

"Two cosmologies, two destinies, one autonomous which leads to secularization, and another teonomical, which crowns itself with the transfiguration. As long as the man will remain the slave of the first one of an autonomous cosmology which disregards God, will permanently live the inner tear between his exterior tendency of dominating the world through science and technology and the inner tendency of becoming worlds and its natural laws slave, through his adherence to what is sensual and material. This actually also explains the enormous gap between the technological progress of our times and the spiritual and moral regress of the contemporary man, attesting the word of the Messiah that the man has nothing to gain if he conquers the world, but he loses his soul." [15]

#### 5. Referances

- [1] Tache Pr. Conf. Sterea, Secularizarea si crizele contemporane, in S.T., nr. 3-4,2003, pag. 18
- [2] Dumitru Pr. Prof. Dr Popescu, Doua cosmologii, doua destine, in Glasul Bisericii, nr. 1-5, 1995, pag. 53
- [3] Ibidem., pag. 36-37
- [4] Gheorghe Pr. Lect. Dr Popa, Secularizarea lumii moderne, o stringenta problema pentru

reflectia teologica, in Ortodoxia, nr. 3-4, 1999 , pag. 264

- [5] Dumitru Pr. Prof. Dr. Popescu, op. Cit., pag. 37
- [6] Tache Pr. Conf. Sterea, op. Cit., pag. 19
- [7] Nichifor Crainic, Nostalgia paradisului, Bucuresti, 1940, pag. 40
- [8] Dumitru Pr.Prof. Dr. Popescu, op. Cit, pag. 82
- [9] Ioan Pr. Prof. Dr. Bria, Rolul si responsabilitatea Ortodoxiei in dialogul ecumenic, in Ortodoxia, nr. 2, 1980,pag 369
- [10] Dumitru Pr. Prof. Dr. Popescu, Ortodoxia și contemporaneitatea, Edit. Diogene, Bucuresti, 1996, pag. 196
- [11] Tache Pr. Lect. Sterea, op. Cit., pag 23
- [12] Dumitru Pr. Prof. Dr. Popescu, Hristos, Biserica, Societate, Edit. Institutului Biblic si de Misiune al B.O.R., Bucuresti, 1998,pag 59
- [13] Idem, Omul fara radacini, Edit. Alfa si Omega, Bucuresti, 2001,pag. 88
- [14] Sfantul Maxim Marturisorul, Raspunsuri catre Talasie, la Pr. Conf. Tache Sterea, op. Cit., pag. 26
- [15] Dumitru Pr. Prof. Dr. Popescu, Ortodoxia si contemporaneitate, Edit Diogene, Bucuresti, 1996, pag. 194-195

*This work was supported by the project "Sustainable performance in doctoral and post-doctoral research - PERFORM" co-funded from the European Social Fund through the Development of Human Resources Operational Programme 2007-2013,contractno.POSDRU/159/1.5/S/138963*

## Statistical Information Valencies Concerns the Economic Records at the University Level

Daniela Vitan

*"1 December 1918" University of Alba Iulia*

[daniela\\_v89@yahoo.com](mailto:daniela_v89@yahoo.com)

### Abstract

*In order to know the how to organize the activities of public institutions the economic information system can be used as well as its main components: accounting and statistics.*

*Thus, throughout this work "Statistical Information Valencies concerns the Economic Records at the University level" we plan addressing issues relating to their role in the economic information system and in the calculation of statistical indicators, which may enable the knowledge of the correlation between certain elements.*

**Key words:** information system, economic record, statistical correlations, students

**J.E.L. classification:**

### 1. Introduction

Statistics is a system of techniques and fundamental methods used to obtain and treat statistics derived from observation, so as to emphasize some characteristics of the population.

Depending on the diversity of the population and the use of statistics, we may classify the statistics into economic statistics, social statistics, medical statistics etc.

Statistical techniques give information on the entire population or only of a certain part of the sample.

This paper aims to analyze the existence and intensity of the relationship between the statistical variables respectively, the fields followed by students and the average graduation based on data from records operative records.

### 2. Research Methodology

Scientific knowledge as a form of human knowledge generally has a complex content.

Scientific research in the field of statistics must be consistent with a different type of scientific thinking. It must be adapted to the specific field of knowledge, it must be appropriate to the nature of the research objective and it must have final, precise goals to follow in order to reach positive results that reflect the desired truth both theoretically and practically.

To be able to perform a research in terms of effectiveness and efficiency we need to acquire new knowledge in the chosen field research.

For this reason, we chose to highlight in terms of statistical indicators of the correlation between specializations followed by students and the average graduation. As a basis for this approach we used specific statistical indicators and the specialized literature.

The methods that we used were: observation, reasoning, analysis, synthesis, interpretation. The observation was used to investigate the role of statistics in relation to the economic evidence. The reasoning was used during the theoretical documentation, but also for data interpretation results following statistical analysis. Information taken from specialized literature and factual documentation were synthesized and interpreted using statistical instruments in order to highlight their value, their theoretical and practical validity and importance.

### 3. Economic Records and their Components

The knowledge of the state and operation of public entities is necessary for organizing and conducting economic activity at a

microeconomic and macroeconomic level. This knowledge is achieved using the economic information system.

The information system is organized as a whole system of integrated data and information, including the procedures and methods used for their collection, processing and transmission [4].

The economic information system refers to all the means and procedures to obtain the store and use of information in an area of the economic activity as a result of an investment of human and capital resources [4].

This system has a complex character resulted from economic planning, economic record and the economic-financial legislation.

The main information source of the system is taken from the economic evidence because of the need to reflect systematic and in order the operations carried out by the economic entities. The forms of economic record are: accounting, statistics and operative records.

As a main form of economic record, the accounting is a unified methodological subsystem that contributes to accomplish the objectives of the system by the fact that his product has an information content that consists of digital data which are expressed in value and are characterized by precision, continuity, correlation and completeness.

The field of statistics is a system of techniques and fundamental methods used to obtain and treat statistics derived from observation, in order to emphasize characteristics of the population.

As a form of economic records, statistics establish interdependencies between various phenomena, ways of expression, their trends, extrapolating the future trends.

Having a complementary role for accounting and statistics, economic records allow the reflection of general economic information, thus ensuring the completeness of economic information system.

#### **4. Statistics regarded in the Economic-Information System**

Future guidelines depend on the analysis of past accounting, but which, however, will not be able to seize the means of future action, which determines the need for a

complementary tool, which is the statistics [3].

Unlike the other two components of the information system – economic statistics has a much broader scope regarding social phenomena in the economic mainstream. The aim of statistics includes cultural phenomena, demographic, natural, etc.

Statistical evidence studies the quantitative side of the social phenomena, the regularities in the development of concrete conditions of place and time, in their numerical expression [4].

Statistics results from a combination of modern social scientific and administrative practices with technical forms - social spaces that enable the creation of equivalence decisions to facilitate comparisons of the various socio – economic decisions [3]. Thus, it succeeds to level the public space where the indices, the indicators and the social rhythms with a relative stability serve as reference points for collective social analysis.

Statistics contains concepts and techniques that present both the descriptive manner of statistical population approach as well as techniques belonging to inferential statistics which refer to populations having an economic character.

Evolution of the number of students, the percentage of the total population elements and other studies are part of the study of statistics. These statistical studies offer the opportunity to find out the current situation and the issues that may affect the approach of universities while providing good chance of improving the situation through correction of any difficulties that were discovered.

Regarding the education institutions, the informational – economic system ensures through statistics and accounting proper records of the phenomena and processes as well as conducting studies on the current status, population size and trends evolution.

#### **5. The analysis of the correlation between the specialization the students attended and the graduation**

In multivariate statistical distributions study we can ask the question whether there is or not a link between the observed variables and through them, between the phenomena they represent [1].



The analysis of the correlation between two variables involves the establishment of any link, its strength measurement and analytical expression of this bond. Knowing these links involves the construction of statistical models (also called econometric models or regression models). This analysis can be accomplished through a descriptive method (the correlation table) or a quantitative method.

Studying the sample, in order to analyze the existence of a correlation, we assessed  $\chi^2$  and compared with zero and for the intensity of the correlation  $r_{01}$  compared with 0 and 1 [2].

The correlation report involves taking into consideration of the absolute frequencies of the correlation table and the dependent variable values, being able to calculate when the dependent variable is quantitative.

This report is based on the rule of the sum of dispersion, according to which the change of a variable Y is decomposed in two parts:

the dispersion between classes and dispersion within classes, if the statistical units of the studied population are divided into classes in report with the values of the factorial variables:  $V_{TOTY} = V_{EXPY} + V_{REZY}$ , where  $V_{TOTY}$  is the total variation of the variable Y,  $V_{EXPY}$  measures that part of the variation of Y caused only factor X and  $V_{REZY}$  and Y represents the residual variation caused by other factors that were not considered.

Extending information to the entire population is possible by building statistical tests for the unknown parameters  $\chi^2$  and  $r_{01}$

And, so as to highlight the theoretical approach, we considered necessary to practically treat the calculation of the correlation between specializations -x and graduation average - y. This task was achievable because accounting ensured the theoretical support for statistics needed to calculate indicators and making correlations.

**Table nr. 1 Results of the statistical observation**

<b>y \ x</b>	<b>Accounting and informatics management</b>	<b>Marketing</b>	<b>Assistance in management</b>	<b>Sociology</b>	<b>Total</b>
9-10	117	61	15	28	<b>221</b>
8-8,99	106	30	17	12	<b>165</b>
7-7,99	53	35	17	14	<b>119</b>
6-6,99	6	12	3	3	<b>24</b>
5-5,99	5	0	0	0	<b>5</b>
<b>Total</b>	<b>287</b>	<b>138</b>	<b>52</b>	<b>57</b>	<b>534</b>

Source: autor's projection

The graphical representation of the data is the following:

**Graphic. 1. The evolution of the number of students according to specializations**

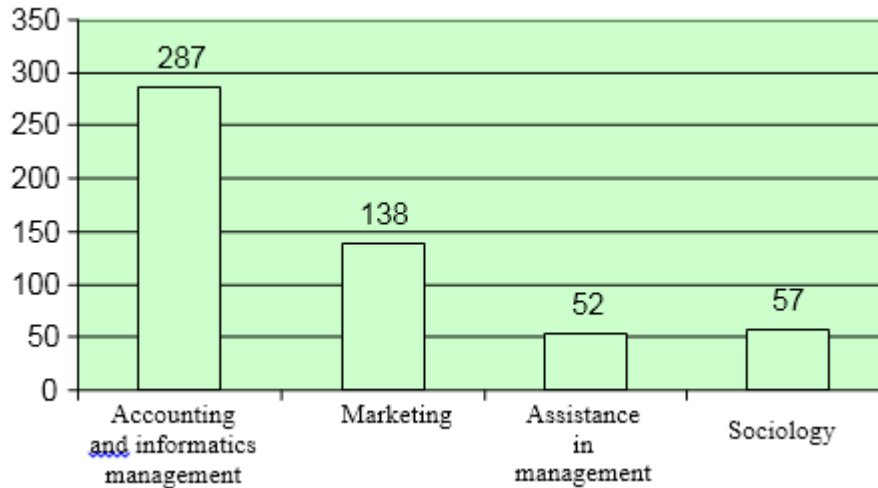

Source: autor's projection

Taking into account the data presented above our objectives are to:

- Analyze if there is a correlation between the specialization and graduation average;
- Complete an analysis of the intensity of the correlation;
- Complete the test regarding the intensity of the correlation.

a) We calculate the parameter  $\chi^2$  ( chi square)

$$\chi^2 = \sum_i \sum_j \frac{(N_{ij} - N_{ij}')^2}{N_{ij}'}$$

$$\chi^2 = \frac{\left(5 - \frac{287 * 5}{534}\right)^2}{\frac{287 * 5}{534}} + \frac{\left(0 - \frac{138 * 5}{534}\right)^2}{\frac{138 * 5}{534}} +$$

$$\dots + \frac{\left(28 - \frac{57 * 221}{534}\right)^2}{\frac{57 * 221}{534}}$$

It is enough to demonstrate that a term is positive. Calculating the first report we obtain  $1,98 > 0$ , which means that there is a correlation between specialization and graduation average. Once we have demonstrated that there is a correlation between these two variables we can reach the next step which its o determines the intensity of the connection among the variables.

b) In order to calculate the intensity of the connection it is necessary to obtain in the first step(the existence of the connection) a

positive result. The formula to calculate this is the following:

$$r_{01} = \sqrt{\frac{V_{exp}}{V_{tot}}}$$

To calculate  $V_{tot}$  it is necessary to calculate the average of y:

$$\bar{y} = \frac{5,495 * 5 + 6,549 * 24 + 7,495 * 119 + 8,495 * 165 + 9,5 * 221}{534}$$

$$\bar{y} = 8,570$$

The graduation average of all the specializations is the following 8,570.

$V_{tot}$  may be also written as  $\sigma_y^2$

$$\sigma_y^2 = \frac{(5,495 - 8,570)^2 * 5 + (6,495 - 8,570)^2 * 24 + (7,495 - 8,495) * 119 + (8,495 - 8,570)^2 * 165 + (9,5 - 8,570) * 221}{534}$$

$$\sigma_y^2 = V_{tot} = 0,899$$

The number of specializations deviates quadratic as  $\pm 0,899$  from the graduation average with 8,570.

In order to calculate  $V_{exp}$  we need to calculate the average conditioned of y in correlation with x.

$$\bar{y}/x_1 = \bar{y}/\text{cig} = \frac{5,495 * 5 + 6,495 * 6 + 7,495 * 53 + 8,495 * 106 + 9,5 * 117}{287} = 8,626$$

$$\bar{y}/x_2 = \bar{y}/\text{marketing} = \frac{5,495 * 0 + 6,495 * 12 + 7,495 * 35 + 8,495 * 30 + 9,5 * 61}{138} = 8,512$$

$$\bar{y}/x_3 = \bar{y}/\text{assist. manag.} = \frac{5,495 * 0 + 6,495 * 3 + 7,495 * 17 + 8,495 * 17 + 9,5 * 15}{52} = 8,343$$

$$\bar{y}/x_4 = \bar{y}/\text{sociology} = \frac{5,495 * 0 + 6,495 * 3 + 7,495 * 14 + 8,495 * 12 + 9,5 * 28}{57} = 8,638$$

$$V_{\text{exp}} = \frac{(8,626 - 8,570)^2 * 287 + (8,512 - 8,570)^2 * 138 + (8,343 - 8,570)^2 * 52 + (8,638 - 8,570)^2 * 57}{534} = 0,008$$

$V_{\text{exp}} = 0,008$   
From the average total 0,008 is due to the number of specializations.  
As we have determined  $V_{\text{tot}}$  și  $V_{\text{exp}}$  we can calculate  $r_{01}$ :

$$r_{01} = \sqrt{\frac{0,008}{0,899}}$$

$$r_{01} = 0,094 \in [0,1]$$

0,094 < 0,50 – the intensity of the correlation is low.

c) The test regarding the intensity of the correlation

We can follow the following steps:

1). Formulating the hypothesis

$H_0: r_{01} = 0$  (the intensity of the correlation is not significant)

$H_1: r_{01} \neq 0$  (the intensity of the correlation is significant)

2) Following a sample of 534 students we estimate  $r_{01}$ :  $\hat{r}_{01}$

$$\hat{r}_{01} = \sqrt{\frac{V_{\text{exp}}}{V_{\text{tot}}}} \in [0,1]$$

$$\hat{r}_{01} = 0,094$$

3) The statistical test is based on the random variable F

$$F = \frac{r_{01} / (J - 1)}{(1 - r_{01})^2 / (N - J)} \in F(J-1, N-J)$$

4) Determining the accepted area of the hypothesis. Having a risk  $\alpha$  of 5% and regarding the freedom degree of 1, n- J it results:

$$\alpha = 5\%$$

$$J-1 = 4-1 = 3 \Rightarrow F_t = 2,60 \Rightarrow \text{accepted area } (0, 2,60)$$

n- J = 534-4 = 530  $\approx \infty$   
 $F_t = 1,5$  – obtained from the data in the Fisher law chart.

5) Determining a particular value of the variable F :  $F_c$  ( F calculated)

$$F_c = \frac{\hat{r}_{01} / (J - 1)}{(1 - \hat{r}_{01})^2 / (n - J)}$$

$$F_c = \frac{0,094^2 / 3}{(1 - 0,094)^2 / 530} = 1,575$$

6) Making the decision:  $1,575 \in (0, 2,60) \Rightarrow r_{01} = 0$  (rejecting the alternative hypothesis and accepting the null hypothesis) – at the level of the population the correlation between the average graduation and the specialization is low.

The calculations resulted in a less significant correlation at both the sample and the population between the graduation average and the specialization.

## 6. Conclusions

The issues presented above lead us to formulate the following conclusions:

- The organization of any entity is subject to providing an information system - based on proper economic planning and economic evidence on compliance and economic – financial legislation.
- The main source of this system is the accounting. Through it, we can give microeconomic data but also the necessary data for the managers regarding the entity. Studying the phenomena outside the entity and providing their quantitative evidence is possible only with the help of statistics.
- Instruments and statistical indicators made it possible to analyze the existence

and intensity of the relationship between variables: specialization and average graduation. The calculations resulted in a less significant correlation at both the sample and the population between these variables.

Thus, we can say that statistics is an indispensable element in the life of any entity as the data provided by the accounting are taken by the statistics in the calculation of the indicators that allow knowing the operative state of the entity.

## 7. References

- [1] Breaz N.M., Jaradat M., 2009, *Statistica descriptiva. Teorie si aplicatii*, Risoprint Printing House, Cluj-Napoca.
- [2] Breaz N.M., 2010, *Introducere în econometrie: note de curs si seminar*, Series Didactica, Alba Iulia, 2010.
- [3] Cenar I., 2006, *Contabilitatea asigurărilor în sistemul de pensii din România, Dominatia regimului public*, Casa Cartii de Stiinta Printing House, Cluj – Napoca, 2006.
- [4] Horomnea E., 2008, *Fundamentele stiințifice ale contabilitatii*, Tipo Moldova Printing House, Iasi.

## 8. Acknowledgement

This paper has been prepared with the financial support of the project "Quality European Doctorate - EURODOC", Contract no. POSDRU/187/1.5/S/155450, project co-financed by the European Social Fund through the Sectoral Operational Programme "Human Resources Development" 2007-2013

## Dimensions of World Food Issue in the Ecological Crisis

Alina Voiculescu

"Constantin Brâncoveanu" University of Pitești

[alinav06@yahoo.com](mailto:alinav06@yahoo.com)

Nicoleta Belu

"Constantin Brâncoveanu" University of Pitești

[nicolbelu@yahoo.com](mailto:nicolbelu@yahoo.com)

### Abstract

*No matter how paradoxical it might be nowadays in full technical and scientific revolution, when there is a strong growth of agricultural production worldwide, many countries are facing a food issue which tends to worsen, being a factor of destabilization of international life.*

*Scarce access to food resources caused by economic reasons is the main cause of hunger, faced by most of the Earth population. Its largest proportion is in Sub-Saharan Africa and also in countries in Asia, the Middle East, and even Latin America and the Caribbean are facing this problem. As it is a primary need (the need for food), the incapacity of the entire Earth population to meet it is a concern for the competent bodies in this area.*

**Key Words:** malnutrition, undernourishment, hunger, food crisis.

**J.E.L. classification:** F60

### 1. Introduction

It is estimated against the background of demographic boost that in the year 2050, the world population will be around 10 billion inhabitants. Therefore, feeding human kind in the 21<sup>st</sup> century is a serious environmental issue as demographic growth already takes place in areas where chronic hunger reigns and where climate changes will be more evident than elsewhere. Ever since the 18<sup>th</sup> century, since Malthus, many researchers have highlighted the distortion between population growth and resources.[1]

The doubtful actions of some countries aimed at fighting hunger on the planet are not enough to meet population growth

worldwide. However, experts believe that we do need more food, but better management of the existing resources: "There is no such problem as being unable to feed the whole population of the globe. Current production is absolutely sufficient to ensure food for all human beings. Or, better said, the annual output is more than we need, without having reached the maximum possible food production limit, which can be even doubled effortlessly", said Benedikt Haerlin, an expert of the Foundation for Agriculture Future.[2]

### 2. Essence of Food Issue

The dimensions of the food issue are generated by the proportions of *hunger* (starvation), *undernourishment* (poor feeding) and malnutrition around the globe.

**Hunger** is the general condition of physical shortage of food. **Undernourishment** is poor diet quantitatively, whereas **malnutrition** means very pronounced qualitative deficiencies, namely food that does not contain proteins and general nutrients.[3]

According to the United Nations Food and Agriculture Organization (FAO), about one in five people in the developing world, does not eat well. Additionally, 795 million people worldwide do not have sufficient access to food in order to live healthy active lives.[4]

Malnutrition is typical even to developed countries. Thus, 10% of the US population is affected by this problem because of the big gap among incomes. Almost 76% of those affected by the issue are part of the black population.

Malnutrition in the world today has three forms:

- hunger;

- scarce vitamins and mineral salts;
- overweight.[5]

Worldwide there has been a strong polarization of food consumption: **on one hand**, about two thirds of the world population mostly in developing countries, are facing hunger and malnutrition issues, whereas **on the other hand**, a minority located mostly in industrialized countries consumes over normal levels. Overnutrition has been called by the World Health Organization "*one of the greatest neglected public health problems of our time*".

The persistence of hunger, undernourishment and malnutrition has particularly deep negative implications:

1) Firstly, individuals' physical and mental development is prevented, decreasing their productive capacity, their efficiency in getting involved in the implementation of various activities;

2) Secondly, social implications should be mentioned. Most of the population affected by hunger is in rural areas. Hunger is one of the causes of migration to urban areas with all the problems it entails (increasing unemployment, expanding insalubrity, etc);

3) Finally, food problem has serious political implications for the affected countries. In general, the source of social tension or of increasing political instability are the protests and actions of people affected by hunger. On the other hand, given that the food needs are increasing and domestic production cannot meet them, they take the form of food aids or according to commercial terms. There are cases where suppliers have imposed political conditions, even resorting to the violation of national sovereignty prerogatives in the beneficiary countries.

Persistent malnutrition reflects a failure of the development process. Almost every country in the world is facing malnutrition which means a serious risk to public health. Between 2 and 3 billion people are malnourished, overweight or obese.

### 3. Causes of Food Issue

The amplitude of food issue, the multiple negative consequences it has, both domestically and internationally have caused an increasing concern to identify the causes and ways to solve it. Is world food issue

subject to natural disasters (droughts, floods, desertification) or to the demographic boost?

Of course, the influence of natural factors cannot be denied. Lately, the desert in certain regions of the world has spread by 10 km per year. The beginning of food crisis coincided with poor harvests due to severe drought in very large areas of the globe.

The impact of population boost on food requirements cannot be ignored either. Not incidentally, hunger has become acute in a country like Bangladesh.

The current global food production could provide substantial improvement to the consumption in developing countries. But this would require a radical change in the food supply system. As mentioned in one of the reports to the Club of Rome, entitled "**World Order Restructuring**": "*The problem occurs because production is distributed unevenly among different countries as well as among different segments of the population within the same country*".

Although food prices have increased, most Americans, for example, are not aware of the seriousness of the issue. 40% of the US food is thrown away and ever since 1974, the amount of food that a person wastes has increased by 50%.

Hunger kills more people than AIDS, malaria and tuberculosis do all together. Three quarters of the population in developing countries live on less than 2 dollars a day.

Because of the population boost, the need for food will increase by 70% until the year 2044.[6]

Despite the progress at global level, hunger in the world is still "serious", with about 800 million people continuing to suffer from hunger.

Table 1 provides an overview of the **Global Hunger Index (GHI)** at world level, the number of countries affected by this issue being unfortunately on the rise.

**The Global Hunger Index** is calculated as follows:  $GHI = (PUN + CUW + CM)/3$

With:

**GHI**: Global Hunger Index

**PUN**: proportion of the population that is undernourished (in %)

**CUW**: prevalence of underweight in children younger than five years (in %)

**CM**: proportion of children dying before the age of five years (in %)

Table 1. Global Hunger Index, 1990, 1995, 2000, 2005, and 2014

Global Hunger Index (GHI) - years	Number of countries with GHI
1990	97
1995	117
2000	117
2005	118
2014	120

Source: International Food Policy Research Institute, Concern Worldwide, Welthungerhilfe, Global Hunger Index 2014, The Challenge of Hidden Hunger, p. 40

It is becoming more and more evident that the real cause of the precarious food situation in developing countries is the delayed condition of agriculture and in general of the economies in most of them. The relationship between underdevelopment and poor nutrition in the world is direct.

In a final analysis, the scale of per capita gross product is what generates the proportions of calories and proteins in one's daily food.

The current situation in many developing countries is also due to internal factors, to a wrong orientation of agrarian policies. There are a lot of developing countries which have adapted foreign methods of economic growth, neglecting agriculture, the development of traditional cultures, the encouragement of farmers. This way, dependence on the outside has increased, young countries soon becoming net importers of agricultural products.

The interdependence with other environmental and global economic issues play a major role in setting the dimensions of the food issue.

Increasing oil prices has seriously affected the programmes of non-oil developing countries, aiming at the supply fertilizers in agriculture.

At the same time, increasing the import food needs leads to worsening the difficulties in the balance of payments of the countries concerned, given the unfair conditions where foreign trade is conducted, the increase in food prices, the instability on the monetary-financial market.

#### 4. Increasing Agricultural Production – One Solution to Solve Food Issue

Agriculture, above all, is the main source of food for the population of a country, and in developing countries, one of the main branches of national economies.

Food issue is social, economic and political. During the 90's last century, the world did manifest some positive trends in solving the food issue. Green Revolution in Asian countries favoured solving the issue, especially in the most populated countries, such as India and Bangladesh. In contrast, in African countries, it did not succeed because of prolonged droughts. Changes in the structure of world acreage show a growing trend of surfaces with intensive crops. Thus, the acreage of soybean, sunflower, rice and corn has doubled.

There have been relevant changes occurring in cereal acreages, cultures for the world food basis and for the development of the livestock sector. The trend of intensive land use worldwide has become more obvious. Developed countries hold the highest share in the structure of the following crops: wheat, potatoes, grapes, - and developing countries in crops such as rice, corn, soybeans, coffee, tea, cocoa. The concentration of areas with grains and oilseeds in developed countries makes it possible for basic foods of mankind, with yields greatly exceeding needs. In recent decades, the amount of food produced has increased a lot, but let us not forget that along with population growth, food demand will grow, too.[7]

Taking account of the causes that have led to the world food situation, it is becoming very clear that a viable, long-lasting solution to this problem can only be secured by substantially increasing and diversifying agricultural production. This requires the development of coherent strategies and policies for the development of agriculture.

Between 30 November and 11 December 2015, the United Nations Framework Convention on Climate Changes will be held in Paris. The objective of the conference is the conclusion of a mandatory and universal climate agreement that is accepted by all nations. In this event that puts climate in the center of global political debate, the focus is on energy, heavy industry and transport, and

beside the discussions there is the relationship between food and climate.

The paradox of the current industrial agricultural-food system is that, on one hand, more food than necessary is produced, while, on the other hand, 800 million people are still starving. Therefore, the solution is not increased production, but applying a completely different system of food production, distribution and access. The entire agricultural-food system must be considered and environment-friendly agricultural methods should be adopted.[8]

## 5. Conclusions

Food issue cannot be approached in an isolated way, but only in close conjunction with other issues and processes that characterize today's global economy, with other global issues. Addressing this question firstly depends on eliminating underdevelopment, the main cause of agriculture backwardness in important regions of the world, of malnutrition and hunger.

Food issue is not confined to developing countries. It affects all the countries in the world, including the developed ones.

It seems paradoxical to speak of food as a global issue when the world produces so much. There is so much food and there is such a diversified range that it is difficult to understand this issue.

According to specialists, a joint effort is required to solve the global food issue, namely, internal efforts along with financial and technical support from developed countries and international institutions.

## 6. References

- [1] [http://www.rgic.ro/securitatea\\_alimentara.pdf](http://www.rgic.ro/securitatea_alimentara.pdf) (accessed on 17 November 2015)
- [2] <http://www.dw.com/ro/c%C3%A2%C5%A3i-oameni-poate-hr%C4%83ni-p%C4%83m%C3%A2ntul/a-4796888> (accessed on 17 November 2015)
- [3] Dumitrescu, S., Gheorghită, V., Marin, G., Puiu, O., *World Economics*, Independența Economică Publishing House, Brăila, 1998, p. 214
- [4] FAO, *State of Food Insecurity in the World*, 2015, <http://www.fao.org/hunger/en/> (accessed on 18 November 2015)
- [5] Bari, I., *Modern World Issues*, Economică Publishing House, Bucharest, 2003, p. 279
- [6] <http://www.dcnews.ro/criza-alimentara-se-acutizeaza-pe-masura-ce-clima-se-incalzeste> (accessed on 18 November 2015)
- [7] <http://www.noiscriem.net/2013/07/asigurarea-populatiei-lumii-cu-produse.html> (accessed on 19 November 2015)
- [8] [http://www.slowfood.com/wp-content/uploads/2015/11/DOC-CLIMA\\_ROM.pdf](http://www.slowfood.com/wp-content/uploads/2015/11/DOC-CLIMA_ROM.pdf) (accessed on 19 November 2015)



**Section II**  
**Business Economy and Administration**

\*\*\*

**Subsection 2**  
**Marketing – Management**

## Innovative and Technological Transfer – a Requirement for Ensuring Economic Development

Ileana (Bădulescu) Anastase  
TOMIS University of Constanta  
[anastaseileana@gmail.com](mailto:anastaseileana@gmail.com)  
Cornel Grigorut  
OVIDIUS University of Constanta  
[cornel\\_grigorut@yahoo.com](mailto:cornel_grigorut@yahoo.com)

### Abstract

*Abstract. A definition of the enterprise is proposed, the factors that determine the period of operation of the enterprise are listed; analyses regarding the viability, longevity of the operation of the enterprise are carried out; innovations, labor productivity, the structure of the end product offered by the company, market demand for the respective products are the main preoccupation of the company manager. It is argued the proposal to develop a national programme of increasing labor productivity.*

**Key words:** products, enterprise, viability, consumers, technologies.

**J.E.L. classification:** A11

### Introduction

Enterprises can be: mammoth, big, small they may disappear, they can have different relationships with other enterprises, including productive, organizational, technological, partnership ones, they may merge, set up etc. In the world we will not find any enterprise that has survived, for example, for 100 years, with the same functions, end products, consumer relations, using the same raw material etc. We can say that the company also has a beginning, and an end. For a proper description of the enterprise reality it is necessary to define the notion of reality. To the question asked by Rumelt R. in 1984, 'What is an enterprise?', we can find various approaches with different levels of success. We shall further on use our own definition of the enterprise: The enterprise is a regulated system, institutionalized or not, of

elements and flexible internal and external connections, within which decisions can be adopted and made: what, how, how much, when and for whom the provision of services can be offered and the intelligent material or spiritual goods can be created. Theoretically, there may be other definitions as well. Each definition has its advantages and disadvantages. In the above perspective on the concept of enterprise it is specified that the system (the enterprise) may be legal, or illegal (non-institutionalized). If, when the definition includes only legal enterprises, then they remain outside the analyses of shadow economic activities, which in some countries exceed 40% of GDP. The system elements (enterprise components) are made up of living labour (labour force) and materialized labour (machinery, workshops, technologies etc.). The system connections are represented by the connections between the system components (internal connections), the enterprise (system) and other businesses, markets (external connections).

Both the elements (employees, fixed assets, productive variables) and the system connections develop in the course of time, and change under the influence of internal and external factors. Economic competition requires that companies to streamline activities by implementing innovations.

Innovations can be made within each element (productive fixed assets can be replaced by other more effective funds; employees can be trained using new methods etc.) for external connections.

**Chapter I. The statements can be exemplified,**

In order to reduce the lag of drug testing

from a to z, Eli Lilly company engages the network firms in this process. Innovation lies in the fact that the corporation has created a team of performers where each member assumes the cost of testing a single drug; a collective work has been created with a clearly defined specialization for each enterprise, in which double work for the testing of one and the same drug is excluded. This innovation in the organization of funding the testing activities occurred in 2001 when Eli Lilly Company placed InnoCentive Web-site that presents an open market of innovations. On the Web-site, the companies which are looking for the best financing solutions anonymously express (formulate) their problem. The intellectual potential of Web-site consists of over 140,000 partners from 175 countries. [1] Intellectuals, producers of innovations in the forms of organizing finance, who succeed in proposing optimal, acceptable projects earn about US \$ 1 million. On the basis of innovations in a successful scheme of activities, the company obtains copyright and other companies can use the same financing scheme in exchange for payment. [2] The participation of several companies to financing innovation in the optimal organization of these activities can allow for: reducing costs; increasing the number of innovative elaborations; accelerating companies' activities; increasing commercial revenue. [3] The future managing director is more inclined to accept the innovations that generate radical changes in the organization processes of internal, external activities, the productive technologies, the relations with competing partner companies. [3], [4], [5]

Whenever it comes to innovations with considerable effects, the manager's preference is also accompanied by feasibility calculations. The future managing director is permanently driven by the desire to surpass his competitors by as many parameters as possible. And here the manager is also helped by the innovations in improving the functioning of each element of the system, the internal and external connections, the structure of end products. [6] According to [7] managers, companies support innovations in organization (40%), the improvement of productive technologies (25%), the branch organization (35%). Innovations in technology have a significant impact on the

enterprise. New technologies can improve the domestic and foreign organizational schemes. Every innovation implemented in some way changes the activities of all the elements and connections of the system; some items may disappear from the system, others may occur. Technological innovations can significantly modify the structure of end products; they can create unprecedented services, eliminate some products and services. If innovations are missing, they contribute to the prosperity of some and the bankruptcy of others. The emergence of electric motor vehicles creates economic, environmental, social premises as well as serious problems for companies that have invested heavily in building capacity for the production of internal combustion engines. Example can be found in any area. Innovations and the market are troublesome factors for the manager. The organization must have not only marketing services but also innovators who can generate ideas, exchange ideas to be implemented within the enterprise.

## **Chapter II. Where there is no progress it can be stated with certainty that it is recession.**

Labour productivity is the key to business success under perfect economic competition. Through labour productivity category we shall understand the end product volume ratio (or the provision of services) towards the number of workers (employees) or the end product volume per worker. At the macro level – that is the GDP per worker. Labour productivity can be calculated at the macro, national economy branches and enterprise level. [5] The increasing of the remuneration level should correlate with GDP growth. In some exporting countries of energy resources under the unjustified growth in global oil prices, natural gas, this correlation may not be maintained. For example, in Russia, between 1998-2007, GDP achieved an annual growth of 7%, and wages increased by 19% exclusively due to the increase in energy resources prices, raw materials exported by Russia. Romania has a sufficiently large labour resources potential, productive capital to ensure annual growth of GDP, comparable to those ratios in EU countries. Romania must justify the creation of optimal ratio between productive accumulation and

availability of labour resources in the country. Improving the Romanian economy becomes possible if the problem is formulated and solved at the local, branch and national level; at the same time Romania will strive for financial, institutional solutions to create productive infrastructure in rural areas chart for processing agricultural raw materials and creating jobs in rural areas. [5], [6]

Labour productivity is the most important factor for ensuring economic growth, people's welfare, the stability of the country's economic development. When the company realizes new successes in labour productivity growth, it manages to create new goods, new additional values for consumers, producers, investors. Labour productivity differs from country to country, it is determined by the quantity and quality of capital assets, technologies, work etc. A certain economic success in increasing labour efficiency in Romania resulted from the productive capacity, remaining from the times up to 1990. These have currently become morally and physically obsolete. National companies need a new economic concept, new systems of job satisfaction. Labour productivity growth naturally contributes to rising unemployment. The unemployment problem can be solved by increasing mobility of labour resources in territorial and professional profile through organizing job retraining centers. Job retraining must be an ongoing process adapted to technological changes. Low productivity is determined by: poor organization of work; outdated production capacities, morally and physically obsolete; overregulation processes (the necessity of a disproportionate number of licences); the lack of complex programs of regional development; the insufficient training of professional work; the underdeveloped financial system. The issue of training specialists by the state for the private sector in Romania is not solved, it is the lack of motivation from the private environment for the participation in the processes of preparation of skilled labour. The problem is not resolved at the institutional level: companies must pay a tax for the use of labour resources, prepared by the state. Low labour productivity can also be explained by the firms trends to grow on the basis of

extensive not intensive factors.

### **Chapter III. These opportunities are becoming fewer and fewer.**

For labour productivity growth it is necessary for the state to address the following issues: to stimulate the creation of perfect markets, to exclude monopoly from the market, to ensure economic competition by institutional acts; to implement methods that will ensure the comprehensive development of all the Romanian counties; to update the training systems of labour resources; to motivate the quality of work and performance studies; to ensure the social security of labour resources which encounter difficulties; to determine the key industries that generate success in increasing labour productivity; to stimulate inventive, creative job, intelligent products; to develop social infrastructure and ensure access for all citizens in the processes of education, intellectual and professional training; to create a system of job satisfaction for managers to increase labour productivity; to develop programs of territorial development for all counties, towns, rural communities; to develop mechanisms to drive private capital in educational processes, productive infrastructure development; to develop the national electronic database following the profile of counties, cities, towns, villages; to stimulate the creation of new jobs; to provide the entire population of the country (not only the unemployed) with the necessary information about jobs; to stimulate perfect competition in all human activities including health care, professional training, public services. [4], [5] High labour productivity, including materialized labour is the foundation of a stable economy, the key to success in market economy conditions. Currently, labour productivity in Romania is below 20% of this indicator in developing EU countries. One of the issues of utmost importance for Romania is the lack of a program for the next 5, 10, 20 years regarding labour productivity growth in Romania. One such program should provide a complex of social, environmental, economic activities to ensure an annual growth rate of labour productivity at a rate above that in Germany, England, Holland and France. Maintaining the current level of

labour productivity will turn Romania into a country bidding illicit work supply for EU. [5], [6]

Such a program should include regional subprograms (counties, cities, towns and villages), the branch, including education, health care, environment, culture, sport etc.

The National Programme for labour productivity growth in the above mentioned profile must solve three problems: to exclude inefficient organization of labour; to shut down all the productive technologies in industry, agriculture and other human activities which are obsolete, defective, morally and physically obsolete; to optimize the structure of end product in all activities.

Labour productivity growth in Romania is not a desire to live better, it is a necessity to survive in conditions of free trade in EU. Romania specializes in exports of raw materials. In the National Programme for labour productivity growth, this "specialization", unfavourable to Romania, but favourable to USA, which imports more than it exports (the net export between Romania – the USA is positive), should review and organize the processing of raw materials in Romania and not the USA. [5]

### **Conclusion :**

The longevity of enterprise functioning is a relative measure which depends on a number of exogeneous and endogenous factors. In literature there are the most various definitions of the concept of enterprise. Following the scientific and practical analyses we can conclude that:

"The enterprise is a regulated system, institutionalized or not, of elements and flexible internal, external connections, within which decisions can be reached: what, how, how much, when and by whom can be offered provision of services, created material, intellectual or spiritual goods".

The enterprise may or may not operate in a long period of time depending on the level of implementation of innovations in technology, the organization, the professional training of employees in agreement with the structure of end product and the demand in the commercial market; Labour productivity is the key to business success. The organization may be economically successful if it systematically updates their productive

and organizational technologies, professional training of employees, if it changes the offer structure in accordance with market demand; if it does not have stable economic partners, but has stable economic purposes. [5]

### **References:**

- [1] Anastase (Bădulescu), I., "Viabilitatea firmei viitorului: sporirea potențialului și anticiparea schimbărilor", Conferința Științifico-Practica Internațională „Editia a VI -a , IEFS, Chisinau 2011, Volumul 1, Octombrie 20-21, Creșterea economică în condițiile internaționalizării, Organizată de Institutul de Economie, Finanțe și Statistică; pp 479 –483.
- [2] . Anastase (Bădulescu), I., Andrusca, M. C., "Managementul Strategic în dezvoltarea întreprinderii", Editura PIM, Iasi, 2013, pg. 380;
- [3] Bell, R., Blitz, A., "Paths to Success: Three Ways to Innovate Your Business Model", IBM Institute for Business Value (June); 2007.
- [4] Piramal, Nicholas, "Announces Drug Development Agreement with Eli Lilly and Company: Collaboration Represents a New Clinical Development Model, 2007.
- [5] . Piramal, Nicholas, India Limited press release (January(2).  
<http://www.nicholaspiramal.com/mediapr40htm/>
- [6] . Stratan, A., Anastase, I., "Dezvoltarea Potențialului Economic al Întreprinderii în Contextul Tendințelor Europene", Editura INCE, 2014; pg.214;
- [7] .Website, InnoCentive.  
<http://www.innocentive.com/>;
- [8] . Годовые отчеты Eli Lilly and Ca. 2002-2007.

# The Approaches on Human Resources Management Practices within Romanian Companies - an Empirical Study

Ionut Antohi

„Ovidius” University of Constanta, Faculty of Economic Sciences

[antohi\\_ionut@yahoo.co.uk](mailto:antohi_ionut@yahoo.co.uk)

Andreea - Daniela Moraru

„Ovidius” University of Constanta, Faculty of Economic Sciences

[amoraru@univ-ovidius.ro](mailto:amoraru@univ-ovidius.ro)

## Abstract

*Human resources management practices proved to be important for the company's performances, allowing it to maintain and develop its activities. Such practices determine flexibility and the capacity of an organization to adjust to the changes that occur in its environment.*

*The Romanian companies are aiming to improve their level of performance and the development of such specific practices under a proper approach represents the solution.*

*This paper intends to analyze the main approaches of these practices based on the result of an empirical study. This study was conducted on companies from Constanta county. These results were compared with the ones provided by other specialized studies regarding Romanian companies in order to create a clearer image on the level of the human resources management practices within the analyzed companies.*

**Key words:** human resources management, specific practices, administrative approach, strategic approach

**J.E.L. classification:** M12, M50

## 1. Introduction

The research concerning the human resources management field has revealed a great deal of interest toward the specific practices topic.

The importance of this subject is justified by the fact that the modern companies consider their employees as valuable resources that need to be developed.

The human resources through their skills,

involvement and level of performance determine overall evolution and performance of a company.

People are considered as a source of competitive advantage for the company even if this idea has been argued by specialists that issued favourable arguments or contrary ones.

This paper intends to analyze the level of development of the specific practices of human resources management within Romanian companies. This paper is structured as follows: first a brief review of the main approaches are presented, then the results of previous studies on this topic are used to present the level of development of such practices within Romanian companies, the next section present the research methodology, followed by a section reserved for data analysis and interpretation.

## 2. The approaches on human resources management practices

There are different approaches regarding the human resources management practices.

One of the most disputed issues is concerning the resources based approach. Human resources management practices are viewed by some researchers as a system that evolved in time, keeping the specific connections between elements that could not be easily replicated by the competitors [1]. Such systems regroup the means that a company relies upon in order to continuously generate competitive advantage.

The development of human resources management practices has been approached by different authors that argued about the development from a strategic or administrative perspective.

The strategic approach was presented in the specialized literature mainly by the roles played by the human resources management professionals. Even if different researchers had presented this approach as the main perspective in human resources management field, there are some studies that proved the contrary.

The results of a study undertaken on Spanish companies highlighted the fact that the other roles such as administrative expert, employee's representative or change agent were more present than the strategic partner one [2].

Furthermore, a study regarding the time used by the human resources management specialists assigned for different activities associated with the above mentioned roles revealed that prevail those activities of administrative nature [3].

Another specialized study has identified the following approaches within the studied companies [4]:

- The administrative approach – it is present in smaller companies and it is associated with a low level of development of such practices;
- The strategic approach – that occurs in the case of the medium and big companies, being associated with a higher level of development of the specific practices.

There are some practices associated with the strategic approach such as the use of flexible working time arrangements, importance granted to training activities, correlating reward with performance appraisal results, performance management and career management are perceived as being important.

In an administrative approach flexible working schemes are not allowed, training expenditures are reduced, there is no correlation between payment and performance appraisal.

### **3. Human resources management practices within Romanian companies**

The development of human resources management practices within Romanian companies is reflected by the result of several studies.

The 3<sup>rd</sup> European Company Survey that took place in 2013, has revealed some

interesting results for the Romanian companies [5]:

- The major part of the Romanian companies that have participated in this survey has a stable recruitment and selection policies, encountering lower problems of finding and retaining the right skilled employees;
- There are numerous Romanian companies that enable their staff to benefit of training programs. The importance granted to these practices leads to the conclusion that a strategic approach in this field is desired. It should be noted that a large percentage (25%) of the companies are allowing their personnel to participate only in on-the-job training programs that could represent a restrictive approach on this activity;
- The Romanian companies have registered a limited allowance for working time flexibility practices, considered to be an element specific for the strategic approach;
- The data analyzed indicate that the domestic companies are using variable pay schemes in a moderate manner. Such a reward practices could indicate a strategic orientation in this case.

The study undergone by Ensign Management Consulting, 3<sup>rd</sup> Edition, in 2014, has revealed the following results [6]:

- In most of the cases the human resources managers are involved in strategy implementation rather than in its development;
- There is a lower level of involvement of line manager in the process of using modern human resources management practices that generates a lower involvement in their employees' appraisal and development processes;
- The performance management practices are still underdeveloped, meaning that many companies are not interested in a correlation between rewards granted and the results of the performance appraisal;
- Job rotation is offered for a limited number of employees;
- The main challenges are considered the performance management and competency management activities.

The results of the mentioned studies

illustrate an acceptable level of development of human resources management practices within the studied companies.

The main approach that is used seems to be the administrative one, but we can notice a strong tendency towards the strategic approach.

#### 4. Research methodology

The research was aimed at identifying and describing the main approaches on human resources management practices within the analyzed companies.

In order to fulfil this task a descriptive research was employed.

The main research objectives included:

- Identifying the human resources management practices used;
- Establish the existence of a strategic or administrative approach in human resources management practices used by the studied companies.

The respondents were human resources managers or managers charged with such activities from companies situated in Constanta County.

The research was employed during september - october 2015, using random sampling. The research tool was a questionnaire consisting of 32 questions divided into several sections. First section includes questions about the respondent and the company (county, city, proprietorship form, number of employees), the second section includes questions oriented to collect information about the practices used in the main area of human resources management (human resources strategy, providing necessary personnel, maintaining and development of the employees, performance management and reward management). This information reflecting the level of development of the specific practices allowed to establish the main approaches used in the studied companies.

Over 50 questionnaires were distributed and after receiving the filled in questionnaires and eliminating those that were incomplete, the analysis was conducted on 30 valid questionnaires using SPSS (Statistical Data Analysis, version 21 for WINDOWS).

#### 5. Data analysis and interpretation

The sample structure as far the proprietorship form is concerned the most numerous companies are from services sector – 56,7%, followed by the ones in the industry sector – 30%, while construction companies represent only 10% from the sample size. This structure reflects the specific economic activity in this county, where the service sector is the most developed.

Considering the number of employees the sample structure is presented in figure below.

Figure 1. Sample structure by employee's number

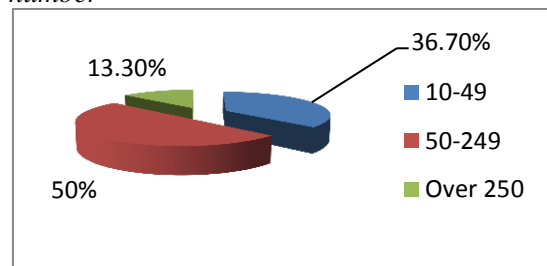

Source: Processing survey data

We can notice that a large number of companies included in the sample are medium companies between 50 and 249 employees. In these companies human resources management practices could be present on a larger scale.

The organizations included in the study have a human resources department in 63,3% of the cases, while 36,7% do not have one.

Regarding the existence of human resources strategy only 30% have declared having one, while 70% of the studied companies do not have such a strategy. Considering this fact we can assume that the administrative approach is the dominant one.

When it comes to evaluate the importance of the specific procedures regarding human resources on a scale from 1 to 5 (1- the least important, 5 –the most important) the result are presented in the table below.

Table 1. The importance of human resources procedures

Category	Medium value of responses
Human resources planning	2.34
Recruitment and selection	4.07



Human resources motivation	3.23
Human resources training	3.57
Performance appraisal	3.63
Career management	1.25

Source: Processing survey data

This situation indicates an administrative approach, but with a tendency toward the strategic one, considering the importance granted to the performance appraisal (3.63) and human resources training (3.57).

Recruitment and selection within the studied companies are based on human resources plan in 43,3% of the cases, while in 56,7% of the situations these processes are based on the spontaneous personnel demand. Such a situation indicates a less strategic oriented approach and rather an administrative one.

The most important methods used to ensure personnel development are training (with a medium score of 3.59), advancement opportunities with a value of 3.45 and team work with a score of 3.87. We can notice the importance granted to the training activities that suggest a further strategic approach toward human resources field.

When career advancements are discussed the most important elements considered are job performances with a medium value of 4.1, experience on the job with a score of 4.03, competencies valued at 3.03 and seniority with a value of 3.7. This situation reflects the importance granted to the employee's level of performance in the process of career advancement, indicating a tendency toward a strategic approach.

The most important elements that are to be considered in the reward system are the worked time by each employee with a medium value of 3.83 and the individual level of performance with a score of 3.73. These results are placing the reward issues in between a strategic approach and an administrative one.

Moreover the use of variable pay schemes that involve additional payments related with performance level at individual level was reported by only 33,3% of the respondents, while the rest of 62,7% are not using such a system. Such a low level of positive

responses indicates a clear administrative approach on this issue.

The same situation is met in the case of team level. A clearer image is presented in the figure below.

Figure 2. Variable pay schemes

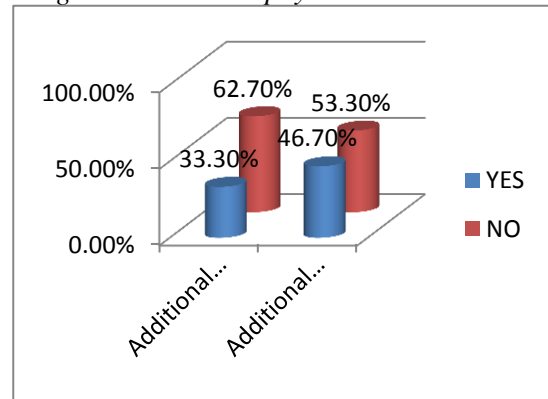

Source: Processing survey data

The relationships management-employees is considered by 56,7% of the respondents as cooperative ones, meanwhile the attention paid by the managers to employee's problems is appreciated in 60% of the studied cases as being at a good rate. These results lead to the conclusion that from this point of view a strategic approach exists.

## 6. Conclusions

Human resources management practices have been subject for researchers and different approaches have been proposed. An interesting debate was the one concerning the strategic approach and the administrative one.

The results of the studies presented in this paper revealed that within Romanian companies such specific practices are still approached in an administrative manner rather than in a strategic one. In the same time there have been identified strong tendencies toward a strategic approach.

The empirical study that has been presented revealed results that sustain the conclusions of the studies mentioned above.

For instance, a strategic orientation could be noticed only in 30% of the analyzed cases. Therefore the administrative approach is still present in human resources management practices within the studied companies.

This fact is proved by the results reflect the importance granted to different activities

specific to the human resources management field. The most important are considered recruitment and selection processes. Moreover, such activities' are not connected with a plan regarding the staffing needs of the companies. They are likely to be connected with the spontaneous necessities for staffing that those companies are facing.

In the same time the importance granted to such activities as personnel training and performance appraisal is reflecting a tendency towards a more strategic approach on this field. The correlation between the results of the performance appraisal process and the personnel training one or between performance appraisal and reward system were not sufficiently investigated and could represent further research themes that could demonstrate in a clearer manner the development of a strategic approach.

The results of the empirical study have revealed the situation of this important field within the analyzed companies. It could be also a good starting point for understanding the development trends regarding the human resources management practices.

## 7. References

- [1] Becker, B., and Huselid, M., "High Performance Work Systems and Firm Performance: A Synthesis of Research and Managerial Implications", *Research in Personnel and Human Resources Journal*, 16, 1, 1998, pp. 53–101.
- [2] Cabrera, E.F., "Strategic Human Resource Evaluation", *Human Resource Planning*, 26, 1, 2003, pp. 41–50.
- [3] Lawler, E. And Mohrman, S. A., "HR as a strategic partner: What does it take to make it happen?", *Human Resource Planning*, 26, 2003, pp. 15-29.
- [4] Razouk, A., Bayad, M., "Evolution of the practices of human resource management in France towards a strategic model: rhetoric or reality?", *The International Journal of Human Resource Management*, Vol. 21, No. 8, 2010, pp. 1207–1227.
- [5] <http://www.eurofound.europa.eu/publications/htmlfiles/ef1386.htm> - Third European Company Survey:First findings.
- [6] <http://www.ensight.ro/wp-content/uploads/2014/09/2014-09-25-Sumar-Executiv-Studiu-HR-2014.pdf>.

## Clusters as a Tool for Development in the Wine Industry

Oana Bărbulescu  
Transilvania University of Braşov  
[oana.barbulescu@unitbv.ro](mailto:oana.barbulescu@unitbv.ro)

### Abstract

*In the continuously changing business environment is difficult for all companies, especially micro, small and medium sized enterprises to be competitive and stay alive. Innovation is the key driver to become competitive.*

*Clusters represent one of the most powerful tools to increase innovative and economic performances of the companies, regions and countries.*

*The 2000s brought along many changes, starting with the modernization of technology, continuing by the increase of the interaction between producers and the emergence of associations which facilitate the development of some common activities and which represent the moment that put its fingerprint on the formation of clusters in the Romanian vineyard field.*

*The wine cluster from Muntenia Oltenia region focused on developing human resources and promoting professional and commercial interests for its members.*

**Key words:** cluster, innovation, wine market, development

**J.E.L. classification:** L160, M140, O320

### 1. Introduction

A cluster represents the interaction between people, companies and public institutions. This enhances their power to develop and influence the development of new products and technologies by creating common strategies and accessing a collective base of knowledge gathered by all those actors. Clusters have the ability to foster the collaboration needed to develop new ideas and bring them to market. By making this collaboration possible, the cluster significantly reduce the efforts needed to launch a new product by setting common

goals and a truly collaborative culture between its members [1].

By other author, cluster is a modern form of association and represents a framework for cooperation between the economic sector, universities, research institutes, professional schools, public administrations and catalyst organizations. These entities have a common point: to develop a specific economic domain. The cluster is one of the most effective structures capable of managing complex issues such as social and economic development of a region, innovation, new technologies, waste management, nature protection, human resources development, job creation and formation of national and international relations. Therefore cooperation between clusters operating in the region is essential [2].

The need of a cluster is more much visible in countries who's private sector is mostly comprised of SMEs for which the main competitive disadvantage is the lack of power to push new products to market, for those and not only, a collaborative system assures a smoother transition from research to production.

The client wants to have confidence in the company's ability to provide the required quality and to maintain this quality. To earn this trust, the company must be able to demonstrate that it has implemented an effective quality management system and implement strategies to increase company competitiveness on the market [3]. Clusters have the power to bring such specialists and companies together and enhance their power to impact the development of products by acting in a collaborative way.

Every country, region and company are in a race to become competitive. This is a continuous cycle and since clusters are the backbone of an economy and drivers of innovation and competitiveness. A cluster is able to:

- to attract creative people;

- to attract capital and investments;
- to develop business with technology leaders;
- to exploit state incentives.

It is crucial for any region in the world to provide a competitive ecosystem both for entrepreneurs, investors, creative minds and talented people to live and work so that the region can become more innovative and have a competitive edge in the global race. Clusters provide competitive ecosystems for the SMEs and this highly depends on the quality of the cluster development process and determination of the cluster management [4].

## **2. The role of the clusters in the wine industry**

In the wine industry there is a growing need to find alternative approaches that can help to address business and products sustainability, whilst at the same time offer opportunities for growth, cost reduction and competitive advantage.

Designing a cluster model is a proven way of supporting and accelerating cluster development. The model fosters collaboration through networks, meetings, advisory services, interbusiness networks, matchmaking events and training sessions. It helps spur innovation by facilitating engagement between companies and between companies and universities as well as other research institutions. It brings international markets closer by way of joint promotion at trade fair, advice on internationalization strategies and market visits.

The three main factors being a prerequisite for successful cluster development:

- a sense of urgency that transcends the political establishment, the business community and ky academic leaders;
- the existence of institutional structures within the business community, the public domain and the research community;
- a group of dedicated community and business leaders, who have the drive and the dedication to be pioneers of the clustering process [5].

When questioning their strategies, company's managers have the opportunity to benefit from the support of cluster policies in

order to improve growth and attain sustainability and competitiveness. The concept of competitiveness thus involves static and dynamic components: although the productivity of a country clearly determines its ability to sustain its level of income, it is also one of the central determinants of the returns to investment, which is one of the key factors explaining an economy's growth potential [6]. When facing today the high degree of maturity of such instruments, cluster developers are themselves confronted to the challenges of renewing and optimizing their strategies and tools.

A cluster should be understood in two ways: the cluster management structure as well as the cluster members. The distinction is not so easily understood as one might think at a first glance and it is not only of theoretical relevance, as cluster management has to act as an interface between national and regional policy makers and financing bodies and members, especially SMEs demanding a huge spectrum of services at little prices. Thus cluster management is tempted to run after publicly financed programmes and face the danger of getting certain autonomy and acting in its own interest moving away from its genuine goal, providing services to the members, especially SMEs [7].

A cluster can play an important role in order to trigger and support the application of the fermentation techniques and enzyme and yeast analysis, the aging period analysis, the management of irrigation and wine training system, the introduction of different clones or varieties in the vineyard. It is obvious that new technologies may be well implemented in the frame of a cluster organisation.

## **3. Romanian wine industry**

Romania is one of the top 15 wine-producing countries in the world, ranking 12<sup>th</sup> in the world and 6<sup>th</sup> in Europe as a wine producer. Similarly, it ranks 5<sup>th</sup> in the hierarchy of vine-growing European countries with a total vine cultivated surface of around 250,000 hectares in 2014. We must clearly indicate that in 1970 this area exceeded 300,000 hectares. Wine grape plantations occupy 82% of the total vineyard area.

The development of viticulture is due to the very favorable conditions that the vine finds throughout the country, especially in the hilly area in the Eastern and Southern Carpathian chain in Transylvania, in Dobrogea and in the west of the country.

The climate, the soil and the nearby Danube represent key determining factors in the development of the vine culture and in obtaining quality wines.

Although there is a rich experience in as far as the wine production is concerned, owing to the absence of a coherent marketing strategy, by early 2000 Romanian wine had a medium level of competitiveness on the world market. In the last 15 years, Romanian producers have made efforts to obtain competitive advantages. At the micro level, they have implemented new production methods, they have resorted to marketing consultancy in order to build and promote their brands and to better position their products on the international market. At the intermediate level, the levels of innovation have increased, intensifying the exchange of ideas and knowledge, with the help of the recently founded association, they have improved the fermentation techniques and enzyme and yeast analysis, the aging period analysis, the management of irrigation and wine training system, the introduction of different varieties or clones in the vineyard).

A feature of the Romanian wine industry in recent years is the increase of investment and the emergence of foreign investors who have brought an infusion of technical knowledge and management. It should also be mentioned the fact that the engagement with European funds by means of the SAPARD program represents an opportunity for wine producers with denomination of origin (DOC). These investments have been used for the diversification of vine varieties, the improvement of soil and wine qualities,

the introduction of new methods and techniques for pruning, irrigation and canopy management, for the further qualification of employees and for the upgradation of the manufacturing process. Currently, the wine is aged exclusively in oak barrels of the best quality, of French, North American or Romanian origin while in most wineries Italian bottling lines are to be found. At the same time, the participation of Romanian producers in international fairs and exhibitions has increased as there are events where Romanian wines have won important awards.

Romania is in top ten wine consumers in the world with 22-24 liters per inhabitant, accounting for only half of the consumption in the developed countries, which represent about 50 liters/ inhabitant.

In Romania 402 wine types can be produced, with the following division into categories: 11 types of daily wine, 42 superior quality wine types, 118 superior quality wine types with denomination of origin and 231 wine types with denomination of origin and quality stages.

The total wine production in Romania varied around 5.000.000 – 6.000.000 hectoliters annually. In the '80s, the production of raw wine soared in some years (1983), to record values 8,000,000 hl. After 1989, the total wine production shrank, being of around 5,000,000 hl annually.

The quality wine produced in Romania represents a smaller share of the total wine production, never representing a quarter of the total production in the last 5 years.

Besides the inner production, annually there is wine import which adds to the inner wine offer. Similarly, the Romanian wine offer addresses not only the Romanian consumer, Romania is traditionally a quality wine exporter.

*Table 1. Wine production by quality categories, 2010-2014 (hl)*

<b>Wine type</b>	<b>2010</b>	<b>2011</b>	<b>2012</b>	<b>2013</b>	<b>2014</b>
Daily wine consumption	4.670.850	4.296.000	5.040.000	5.747.000	5.932.000
Wine with origin denomination	1.167.700	1.074.000	1.680.000	1.916.000	756.000
Share of wine with origin denomination in total production (%)	20	20	25	25	11

Source: [www.oniv.ro](http://www.oniv.ro) (accessed at 30.08.2015)

The assortment of wines produced in Romania is varied including white wines, red wines, flavored wines and sparkling wine. The species structure of the grapes production in our country is represented by 71% wine grapes, 25% table grapes and 4% other destinations. In the case of wine grapes, 57% of the production is represented by grapes for white wines, 11% for red wines and 3% for flavored wines.

On the Romanian territory, vineyard surfaces are spread in the shape of a continuous chain or separately located, representing, by case, vineyard areas. The vineyard regions are large areas which, generally, overlap the historic provinces, which present some particularities concerning the ecologic conditions, the cultivated species, the technologies, and the level of obtained productions and the qualitative characteristics of the vineyard products. In the 6 historic regions of Romania there is a number of 37 vineyards (vinedos), of which 123 are vineyard centers, to which 40 independent vineyard centers are added and which are situated outside vineyards. Wines produced with various names of controlled origin (DOC) exist presently in every region.

- **Muntenia and Oltenia** vineyard area, which contains the vineyards: Dragasani, Samburesti, Leordeni-Stefanesti, Dealu Mare, (with vineyard centers: Boldesti-Scaieni, Valea Calugareasca, Uralati-Ceptura,

Tohani, Pietroasele, Merei, Breaza, Naieni, Valea Teancului) and Costesti, Severinului and Greaca as well as the vineyard centers Corcova, Sadova-Corabia, Segarca, Turnu Magurele Draganesti-Olt and Dealul Craiovei.

- **Moldova** vineyard area, which contains the vineyards: Odobesti, Panciu, Cotnari, Iasi, Husi, Nicoresti, Dealu Bujorului, Ivesti.

- **Central-Transilvania** vineyard area, which contains the vineyards: Tarnave and Alba Iulia (The Country of the Wine), where the most famous vineyard centers are: Jidvei, Alba Iulia, Blaj, Apoldu, Miercurea, Medias, Tarnaveni, Sebes, Aiud, Valea Nirajului, Lechinta and Bistrita.

- **Crişana and Maramureş** vineyard area, which contains vineyards and vineyard centers such as: Oradea-Diosig, Zalău, Valea lui Mihai, Simleul Silvaniei, Carei and Satu Mare.

- **Banat** vineyard area, which contains the Banat vineyard, which reunites the vineyard centers Silagiu, Dealul Tirolului, Moldova Noua, Recas and Teremia and respectively Arad vineyard with two more important vineyard centers Siria-Madarat and Minis-Bratca.

- **Dobrogea** vineyard area with the vineyards Murfatlar (vineyard centers - Murfatlar, Medgidia and Ceravoda), Sarica-Niculitel, Istria-Babadag and Ostrov.

In table 2 the wine production in Romania (thousand hl) 2010-2014 for the 6 vineyard regions is presented.

Table 2. Wine production in Romania (thousand hl) 2010-2014

Region	2010	2011	2012	2013	2014
Banat	100,5	88,5	52,3	85,6	56,3
Crişana and Maramureş	261,0	241,1	234,9	321,4	161,1
Dobrogea	484,0	442,3	500,8	697,3	482,0
Moldova	2571,5	1711,2	3016,6	3145,3	2861,7
Muntenia and Oltenia	2116,2	2627,8	2664,2	3079,4	2897,7
Transilvania	305,3	259,0	251,4	333,9	229,0
Total	5838,5	5369,9	6720,2	7662,9	6687,8

Source: [www.oniv.ro](http://www.oniv.ro) (accessed at 2.09.2015)

#### 4. Muntenia Oltenia cluster

The region Muntenia-Oltenia which holds ideal conditions for wine production, being situated on the 45° Parallel, similar to the vineyard regions of Toscana and Bordeaux that concentrate the highest number of wine cellars, over 50.

From the beginning until now this cluster succeeded to add value in terms of technology and knowledge transfer, to establish a close link between SMEs, to achieve integration with other industries and developed collaborative relationship between suppliers and clients.

This cluster focused on developing human resources from the wine sector, promoting professional and commercial interests for its members from Muntenia Oltenia region through activities like: technical and soft skills training courses, promoting partnership between cluster's members and with other clusters, involvement in projects and offering consulting and organizing events for sharing best practices and to exchange of experience for members. These events represent a meeting organized with a monthly frequency between representatives of human resources departments of cluster members, where they discussed issues of common interest.

The main objectives of this cluster are: links between companies from wine industry, supporting business development, facilitate the technology transfer, participation in national and international fairs, development of entrepreneurial culture, establish strategic partnerships in Romania and abroad, matchmaking sessions for member companies, supporting start-ups and the other stakeholders of the local and regional business ecosystem, collaboration with academia to adapt the curricula to market requirements, facilitate the access of companies to training programs and guidance for accessing European funds.

## 5. Conclusions

With a few experience the Muntenia Oltenia model of cluster policy demonstrates the positive results. Still there are many challenges ahead of the Muntenia Oltenia cluster policy to be resolved. The most pressing gaps in cluster policies include: little awareness of the cluster concept among policy makers, pure or no embedment of cluster policy in the regional government level, no availability of funding for cluster mapping and evaluation, missing training of professional facilitators and cluster managers, limitation of supported sectors, no incubation of cluster organization start-ups and creating consolidated conditions for the cluster manager's work.

The internationalization is important for continuous growth of the cluster as cluster organizations that engage internationally and will be able to promote fruitful collaboration between their members and relevant organizations in order countries and regions.

Good network and cluster management can contribute to reducing some of the barriers to internationalization and it is evidence that companies in such networks and clusters can easier be engaged in international cooperation.

## 6. References

- [1] Țața I., *Developing innovation ecosystems - the cluster way!*. Day of Clusters, Brașov, October, 2015 pp. 23.
- [2] Vajda L., *Regional development through clusters* Day of Clusters, Brașov, October, 2015 pp. 25.
- [3] Neacșu N.A., *Implementation of ISO 22000 - a tool to increase business efficiency and customer satisfaction. Case Study: SC Prodlacta Brasov*, Bulletin of the Transilvania University of Brașov, Series V: Economic Sciences • Vol. 8 (57) No. 2 – 2015 pp.127
- [4] Kunt V., *Collaborative path to innovation culture and success clusters*, Day of Clusters, Brașov, October, 2015 pp. 14.
- [5] Milojkovic D., *The Balkan Cluster Network- An instrument to facilitate clusters in the Balkans to be*, Day of Clusters, Brașov, October, 2015 pp. 8.
- [6] Drumea C., Spatariu E.C. *On the Competitiveness, between Inputs and Outputs. Romania's Case in the EU*, Ovidius University Annals, Economic Sciences Series 11.2, 2011, pp. 385-390.
- [7] Coșniță D., *Business support services by Enterprise Europe Network*, Day of Clusters, Brașov, October, 2015 pp. 18.
- [8] <http://www.wineromania.com>
- [9] [www.oniv.ro](http://www.oniv.ro)

## Bilbao Effect – Presentation, Examples, Perspectives

Alexandru Bîrsan

*Bucharest University of Economics Studies*  
[alex\\_brsn2007@yahoo.com](mailto:alex_brsn2007@yahoo.com)

Darko Shuleski

*Bucharest University of Economics Studies*  
[darko\\_suleski@yahoo.com](mailto:darko_suleski@yahoo.com)

Crina Veronica Cristea

*Bucharest University of Economics Studies*  
[crina.cristea@gmail.com](mailto:crina.cristea@gmail.com)

### Abstract

*According to Nick Milton, knowledge is undoubtedly the only element that makes the difference between humans and animals. Thus, knowledge is an attribute which is specific only to humans.[1]*

*Given the fact that nowadays society is subject of a steady, yet constant change in terms of economy, social and community, we believe that attention should be focused to designing and implementing new, out of the ordinary project that should enable the growth and well being of a community.*

*The present paper aims on presenting the Bilbao Effect and how it has influenced the cultural and economic reconversions in Spain and France.*

*Going forward, we consider that replicating the Bilbao Effect as a regional project in Romania would have a positive impact in terms of social and economic growth, both regions wide and nationwide.*

**Keywords:** Bilbao Effect, territorial intelligence, knowledge economy

**J.E.L. classification:** R11, R12

### 1. Introduction

Scientist and economic specialists around the world consider that we are witnessing the third industrial revolution, also known as the knowledge revolution.

Aiming at the transformation from the tangible resources economy to the knowledge economy, this change has a great influence in the well being and the long term and healthy

activities of both organizations and regions. However, not all the effects of this change are beneficial for the greater good of a community.

At a first glance, some of the cities and regions which have developed and grew as a result of an intense industrial activity are now in facing difficult times due to both industrial decrease and economic reconversion.

The city of Bilbao, Spain, has been subject to what seems to be a successful territorial and economic experiment, which has helped the city, and the whole Basque Country region to overcome the effects of the great unemployment rate.

Known as the Bilbao Effect, the project is being replicated at a larger scale in the French region of Nord-Pas-de-Calais.

### 2. Brief introduction in the subject of territorial intelligence

The territorial intelligence can be considered a form of economic intelligence identified to a region or a community, rather than an organization.

The economic intelligence can be defined as a set of methods, organized in a knowledge management system that results in the generating data and information used for decision making in order to obtain performance and value for all stakeholders. [2]

Economic intelligence is a set of concepts, tools, methodologies and practices that allow putting together in a meaningful manner, the various knowledge and information in terms of economic development dynamics. This relation concerns in particular: mobilizing



people, treatment and analysis of information and, also, efficient circulation of information and knowledge within the concerned organizations. [3]

"Intelligence" implies knowledge about the competition. It implies knowing information such as profitability or revenue. The ultimate benefit of intelligence is knowing the client and potential client. This helps improving services to customers and to better targeting of those customers the business needs. The process of obtaining intelligent information starts with the need of information of the decision-maker (the one in need of information) and ends with the delivery of that knowledge.

Economic intelligence increases the integration of innovation processes, encouraging the initiatives and activities designed to accelerate the businesses. Researches and debates in this area allow the identification of offensive or defensive methods of economic intelligence, promoting innovation, optimization and control of technology transfer geographical, interdisciplinary and, also, intercultural.

The role of economic intelligence, defined as access to timely, relevant knowledge and information in various stages of the decision-making process was studied based on monitoring information it needs a manager in making decisions. The role of economic intelligence is used more in the final stages of the decision-making process, although easier access would extend its use to other levels of decision making. This, if developed at and not have to complete to complete the information channels of policy makers, only in this case will increase its use. [4]

The concept of economic intelligence focuses on the following cultural goals: the transition from a closed culture to an open one in terms of information and, respectively, the transition from an individual culture, focused on the person, to a collective culture, focus on the group.

The concept of territorial intelligence arose on one hand from the will to make a clearer distinction from the economic intelligence by referring to a sustainable development and on the other hand, from the concept of community development, which refers to voluntary changes within, by and for the community, through a multidisciplinary scientific approach and using the information

technologies. Territorial Intelligence does not limit the territorial development to economic growth or economic competition. It does not consider the territory as a market, nor as a place of competition.

Territorial intelligence is not aimed at eliminating market competition or competitiveness. This regulation aims to limit its harmful effects by developing co-operation areas. It also suggests integrating social costs, environmental and cultural development projects overall budget, taking into account that this is insufficient, because the energy challenges of sustainable development are not only economic. Such community development, territorial intelligence respects two ethical principles derived from the sustainable development: participation and partnership actors. [5]

Territorial Intelligence is based on six ethical and methodological principles:

- Participation of all actors in development, starting with the citizens;
- Global approach of situations characterized by an adequate balance between economic, social and environmental variables;
- Partnership of all the actors involved;
- Addressing the territory as a space of action;
- Generalization of project management and culture of evaluation;
- Developing accessibility to the information society technologies. [6]

### **3. The Bilbao Effect around the world**

The Bilbao Effect refers to the dynamics generated in the late 1990, once the Guggenheim Museum started its activity in Bilbao.

The Guggenheim Museum in Bilbao was opened on the 18th of October and, alongside the ones in New York, Venice, Berlin, Abu Dhabi and Helsinki, is part of the Guggenheim Foundation. Built alongside the Nervion River, in what used to be the city's main source of income, the project cost the Basque government about 100 million USD.

In the first 3 years since its opening, the museum recorded up to 4 million visitors, which generated about 500 million EUR. Furthermore, the regional council has estimated that about 100 million EUR in

taxes were collected during this period of time, more than the total amount invested in building the museum. [7]

Figure 1. The evolution of visitors of the Guggenheim Museum Bilbao

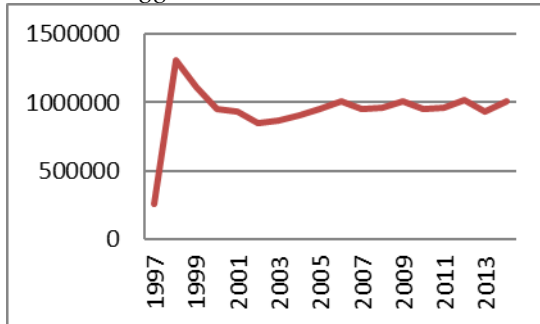

Source: <http://www.guggenheim-bilbao-corp.es>

Another effect was the increase of tourists who chose the Basque Country, in general, and the city of Bilbao, in particular, as a tourist destination. Starting with 1998 (based on the data provided by the Spanish Institute of Statistics), the number of tourists who visited the Basque Country raised from 1,5 million (in 1999) to almost 2.5 million (in 2014).

Figure 2. The evolution of tourists in the Basque Country

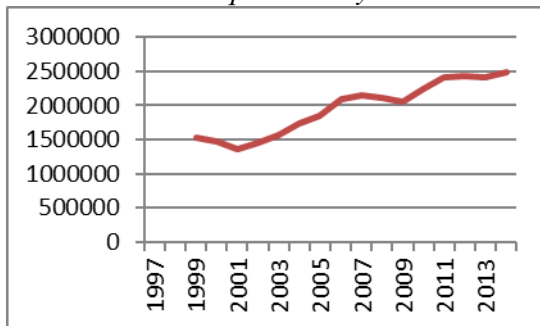

Source: <http://ine.es/>

As the number of tourists visiting the Basque Country increased over the years, it has had a direct influence over the Gross Domestic Product and the unemployment rate of both Spain and the Basque Country.

At the beginning of 1997, months before the opening of the museum, the unemployment rate in Spain was 21,3%, whereas the unemployment rate of the Basque Country was a little under 20% (19,29%). As the museum was opened and it started attracting visitors and, overall, tourists in the region, it had generated indirect

working places, which have had a direct influence, as it can be seen in the below chart.

Figure 3. The evolution of unemployment rate in both Spain and Basque Country

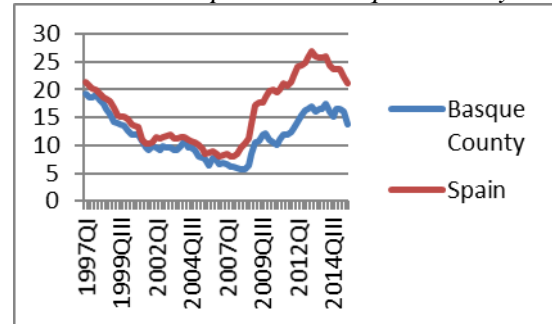

Source: <http://ine.es/> & <http://es.classora.com/>

Given the results of the opening of the Guggenheim Museum in Bilbao, a similar project was launched in the Nord-Pas-de-Calais region in France. Located on the historic Mining Basin, the Euralens Association was formed on the 30<sup>th</sup> of January, 2009 and gathered authorities, business and state representatives.

Euralens Association is a territorial development structure in northern France, which covers an urban complex of 760 square km and has a population of nearly 600,000 habitants. Besides the cities of Lens, Bethune or Hénin-Beaumont, its scope of priority action includes 115 municipalities, 8 centers of excellence and around 20 000 establishments. [8]

The Louvre-Lens Museum was opened on the 4<sup>th</sup> of December 2012, as the first extension of the Louvre Museum outside of Paris. Built on the site of an old stone mine, the park, which hosts the museum, spreads of a surface of nearly 25 hectares. [9]

A study conducted by the association in November 2014 have shown that, since the opening and until January 2015, the museum had about 1,4 million visitors, out which, about one third have spent at least one night in the region.

Furthermore, according to the same study, about 86% out of the visitors have claimed that they would not have visited the region without the existence of the museum. [10]

Even though the association was formed in January 2009, the Louvre-Lens Museum was not opened until December 2012. Thus,

we consider the data from the fourth quarter of 2012 to be the most relevant point of reference.

Figure 4. The evolution of unemployment rate in the Nord-Pas-de-Calais region

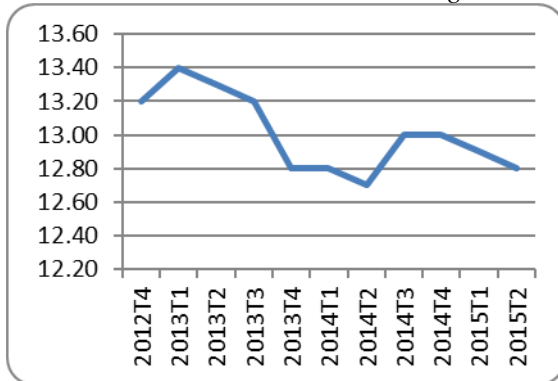

Source: <http://www.insee.fr>

The above chart shows the evolution of the unemployment rate in the Nord-Pas-de-Calais region between the fourth quarter of 2012 and second quarter of 2015. We can see a decrease in the percentage of the rate, from 13,4% at the beginning of 2013 to 12,8% in mid-2015. The reduction is, also, indirectly influenced both by the jobs available with the museum, but also by the effects of it over the other industry sectors, especially tourism.

#### 4. Conclusions

Overall, adding a new point of interest in a disadvantaged area has had an important influence in reviving it and, also in its both social and economic growth.

As shown, the opening of the Guggenheim Museum in Bilbao had an important impact in the economy of the city and, also, of the Basque Country. The increased number of tourists, as a direct effect of the visitors of the museum, has generated indirectly the decrease of the unemployment rate.

Even though recent, the expansion on the Louvre Museum in Lens, named Louvre-Lens has had a great influence over the evolution and the social and economic development of the Nord-Pas-de-Calais region, generating a small increase in terms of new work places.

Given the long industrial history of both locations (Bilbao was well known for its ironworks, whereas Nord-Pas-de-Calais was

great coal mining area), one might think that the change would be difficult and long. However, both Guggenheim Bilbao and Louvre-Lens have been proved to be viable solutions in terms of economic and cultural reconversions.

Considering an ambitious, yet realistic and relevant regional strategy, we strongly believe that the Bilbao Effect can be replicated in different vulnerable regions around the world, including some in Romania. We consider that implementing such a project in Valea Jiului Region or in northern Moldova, for example, would have a great impact in terms of world-wide visibility, tourism, networking and developing small and medium sized enterprises, thus providing a viable alternative for economic growth.

#### 5. Acknowledgement

This work was cofinanced from the European Social Fund through Sectoral Operational Programme Human Resources Development 2007-2013, project number POSDRU/187/1.5/S/155656 „Help for doctoral researchers in economic sciences in Romania”

#### 6. References

- [1] Milton, N., *Knowledge management for teams and projects*, Ed Chandos Publishing, Oxford, 2005
- [2] Nicolescu, O., Nicolescu, C. *Organizația și managementul bazate pe cunoștințe*, Ed Prouniversitaria, București, 2011
- [3] Jamain, Y., *Dispositif d'intelligence économique territoriale, quelles conditions pour l'émergence de communautés ? Le cas de la Chambre Régionale de Commerce et d'Industrie du Poitou-Charentes*, Conservatoire national des arts et métiers institut national des techniques de la documentation, 2009
- [4] Guidebook for Knowledge Management <http://www.smallcitycommerce.eu/>, 2015
- [5] Girardot, Jean-Jacques *Evolution of the concept of territorial intelligence within the coordination action of the European network of territorial intelligence* in ReS-Ricerca e Sviluppo per le politiche sociali Semestrare, ed C.E.I.M. Editrice, San Vincenzo, 2008, pg 5-7

- [6] Pascaru, M. (coord), *Inteligența teritorială, matrice comunitară și guvernare participativă*", Ed Aeternitas, Alba Iulia, 2010
- [7] <http://www.guggenheim-bilbao-corp.es>
- [8] <https://fr.wikipedia.org/wiki/Euralens>
- [9] <http://www.euralens.org/grands-projets/louvre-lens.html>
- [10] [http://www.missionbassinminier.org/fileadmin/user\\_upload/Actualites/Livret\\_Euralens\\_Louvre-Lens\\_chiffres\\_cles\\_et\\_impacts\\_MAJ\\_20\\_nov\\_2014.pdf](http://www.missionbassinminier.org/fileadmin/user_upload/Actualites/Livret_Euralens_Louvre-Lens_chiffres_cles_et_impacts_MAJ_20_nov_2014.pdf)

# Theoretical Approaches and Practical Aspects on the Financial Management of a Local Public Institution

Daniel Dăneci-Pătrău  
Spiru Haret University

[danusidenima2@yahoo.com](mailto:danusidenima2@yahoo.com)

Andreea Arsenie

Constantza Maritime University

[arsenie.andreea@gmail.com](mailto:arsenie.andreea@gmail.com)

## Abstract

*If rigorously stimulated, the quality and method of establishing financial resources in the public institutions, refer to a strategically element of major importance, because it determines the competitiveness at the highest level. The general objective of the study consisted of the local budget establishment and use strategy inspection within a city hall with the purpose of activating an action method to lead to the effectiveness of the process of distributing both own resources and those pertaining to the local budget in the local public institutions.*

*The novelty in this paper is represented by the holistic approach in an original manner of the interaction between financial resources strategic management and the activities specific to the charges and local tax collection and allotment in a public institution defined in the proposition of organizational and efficiency consolidation measures for financial resources activity in the analyzed city hall.*

**Key words:** financial management, local public institutions

**J.E.L. classification:** M48, G32

## 1. Introduction

To improve global performance, any company must react to the evolution of all elements related to financial resources and be aware of their significance. The researches in this paper were aligned to this reasoning and contributed to the development of the information related to the optimization of the income and expenditure budget belonging to

a local public institution. The researches were focused around two main points: *financial management* and *local public institutions*, targeting their associated analysis and the emphasis on the current and perspective exigencies of the local budget formation strategy.

The data and information sources required for the analysis performed were the financial-accounting and statistics records of the Budget-Treasury Service, the Development-Technical Organization Service and Financial-Accounting Service within the City Hall of Baraganu Commune in Constanta County, structured on a content corresponding to necessities. For the unstructured records by such content, the information needed for the analysis, were obtained subsequent to a previous personnel data processing. Direct and indirect observation, photographs of the standard working day and of the charges and tax data base records of the same city hall were also used as instruments for data collection.

## 2. The significance of financial management in a public institution

The production and consumption globalization and internationalization phenomenon imposes the reconsideration of financial management, implicitly leading to the intensification and internationalization of competition on the financial market. As a result of the present economic environment instability, public institutions are determined to organize themselves in a new way, searching for management methods by means of which they are able to control a crisis situation troubling the current existing theories. An essential trait of all modern

approaches is the idea according to which all financial resources must be mobilized in order to achieve the organizational objectives.

In general, the behavior of institutions and decision-makers in the sector of financial decisions, besides being dictated by legislation, normative documents and public institutions' internal or external agreements, is also established by the organizational culture and, in the wide social area, by the social representations conferring significances and structuring hierarchies and priorities. Financial management can be seen, if you simplify it to the maximum, as being formed of two parts: obtaining the allotment and the budget cycle development (spending money and using resources). During both moments, the one of the resources procurement and management, there are factors, which determine the success, the failure, the efficiency and efficacy of actions. By defining financial management, some authors make references to the fact that it represents a resource of development in the sense of the capacity of a potential reality to transform into a certain stability and economic-financial growth [3]. The author of this paper perceives financial management as the science and art of implementing financial processes, meant to guide and organize the company's activities for the capitalization of all financial resources in view of achieving certain performance and efficiency objectives – the intensification of the institution's value, the increase of the patrimony safety.

The financial structure presupposes the analysis of means, resources and needs-resources coherence, a pattern for this analysis being illustrated in figure 1.

Figure 1. Model used in the financial structure analysis regarding the needs-resources coherence

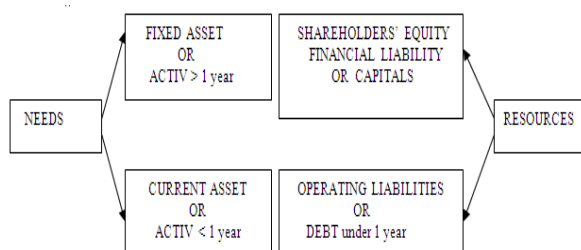

Source: Căruntu, G.N., et al, 2014

The analysis of a public institution's financial structure optimization is essential

being the instrument that helps the management to understand the past and present in view of founding the future strategic objectives for the preservation and development of said organization in a competitive environment. The financial structure analysis performed based on the balance, offers a gamut of useful information for the decision-making process. In agreement with the opinion of a renowned specialist in the finances field, we reckon that a synthetic representation of diverse contexts towards which the financial analysis is oriented, allows the appreciation of the variety of fields where financial analysts can intervene [2].

Public institutions are organisation forms used to provide public services for the state or population. They can establish, organize, reorganize and dissolve, by means of documents enforced by the Parliament, the Government, Ministries or other authorities of the central public specialty administration, as well as documents of the local or county councils, according to the law [7]. In agreement with Androceanu, i think, the role of the public institution is offering best quality public products and services to meet social general needs and specific for natural and legal entities, under conditions of economic efficiency [1]. Moreover, the economic processes performed on the market economy, as well as on other types of economies, are influenced by the state through the public sector.

### 3. Financial Strategy, component of public institutions' financial management

While conceiving and founding the activities of modern institutions, an essential role is ensured by strategies elaborated by management bodies. Each organization's development in time is determined by the selected strategy because the interface efficiency with the systems the organization is part of and the extent to which it maintains or amplifies the market segment occupied depends on its content. In management, the strategy consists of the main measures or actions the managers plan to undertake in order to achieve one or more long-term objectives [5]. The use of the phrase – strategy for the firms' financial structure management dispersed in parallel with the

emergence of a complex, dynamic, indefinite, unstable competitive environment, as well as applying scientific methods in business management at an increasingly large scale. In the context where the strategic management of financial resources is deemed by some specialists as being the process through which financial management relates to the company's general strategy in view of achieving the organization's targets and objectives [4], the financial strategy as component of the company's administration, signifies that part of the enterprise's general strategy, which strictly refers to the financial function, that is why it is a functional strategy.

The opinion of most specialists in the field is that the financial strategy is prepared in time and not as a response to the occurring crisis, thus being *proactive* and not reactive. There is a direct dependence between the financial managers' involvement in the preparation stage and the reduction of the number of crisis for the settlement of which they have to offer assistance.

Component of the company's general policy, the financial strategy has a special influence on the elaboration, distribution and use of funds for the implementation of current economic programmes of development, of increasing the operation and investment cycles efficiency and the entire activity. In agreement with an opinion existing in the specialty literature, we consider that financial policies can have good results only when organically integrated in the overall policy of developing economies in a tough competition on globalized markets [6]. In accordance with the appreciation of a group of specialists, the strategic dimension of the financial resources function is caused by more elements [8]:

- the degree of the function participation in the elaboration of the organization's strategy;
- the creation and development of the function managers' experience in the other fields of activity;
- top management's real vision regarding the financial resources management.

Good fund supply and the selection of financing type represent one of the financial manager's essential task. To this end, a long-term financing plan, which divides the use of funds and predictable resources, is elaborated

to achieve global financial balance. If the internal financial resources do not suffice, the difference will be financed from external resources, through increases in capital or medium and long-term loans, presumably from short-term credits.

#### **4. Analysis of main economic-financial indicators of Baraganu City Hall during 2013 - 2014**

The researches on the financial resources establishment and use, were developed at the Baraganu Commune City Hall in Constanta County. To improve the overall performance, every state institution must react to the evolution of all aspects related to financial resources and be aware of their importance. The research conducted was aligned to this logic and contributed to the improvement of information related to the financial resources establishment and use for the local public institutions. Baraganu Commune is situated in the south-eastern region of the Constanta county, the public local authority being represented by Baraganu Commune City Hall, which has to manage 2 villages (Lanurile and Baraganu) with an equivalent population of 4100. The financing resources are ensured from the collection of local charges and tax, broken-down amounts from the income tax, sums allotted for the balancing of local budgets and amounts broken-down from VAT – for the financing of educational staff costs. This chapter of this work wishes to present a case study regarding the Baraganu local budget financial structure analysis for the period between 2013 and 2014 and to identify paths to enhance the method of collecting local tax and optimizing the increase in incomes to the local budget. Following the researches and the study of financial reports, a similee of the budget accomplished and the estimated budget in 2013 and 2014 was drawn up. Its structure is presented in tabel 1. One can notice that in 2014, in terms of percentage, the total revenue were higher compared to the estimated ones in 2013, which indicates a better collection of revenues to the budget. This improvement, as we appreciated it, was due to a sustained program for the increase of the local civic spirit, initiated by the Baraganu commune Mayor in 2014, but also to a correct taxation of the local economic activities.

Table 1. Similee of accomplished and estimated revenue - *thousand RON*

INDICATORS	2013			2014		
	Estimated budget	Accomplished budget	%	Estimated budget	Accomplished budget	%
<b>TOTAL REVENUE</b>	<b>2,909</b>	<b>2,573</b>	<b>93</b>	<b>10,484</b>	<b>10,087</b>	<b>96</b>
<b>I. CURRENT REVENUE</b>	572	354	68	857	462	54
A. TAX REVENUE	457	270	66	761	388	51
A.1. Direct tax	401	218	63	635	290	46
A.2. Indirect tax	56	52	93	126	98	78
B. NON-TAX REVENUE	115	84	73	96	74	77
<b>II. UNEARNED INCOME</b>	72	73	~100	88	85	97
<b>III. STATE BUDGET TAKEOFFS</b>	2,339	2,329	~100	9,216	9,216	100
<b>IV. SUBSIDIES</b>	46	37	80	323	324	~100
<b>V. AMOUNTS FROM THE WORKING CAPITAL</b>	80	80	100	-	-	-

Source: Accounting Department within Baraganu City Hall

A graph of revenue collected during 2013 - 2014 is presented in figure 2, where the local budget collections in 2013 represent approximately 25% of the revenue in 2014. This was especially due to the distributions from the state budget of 9216 RON in 2014, compared to 2329 RON in 2013.

Figure 2. Total revenue accomplished in 2013 compared to 2014

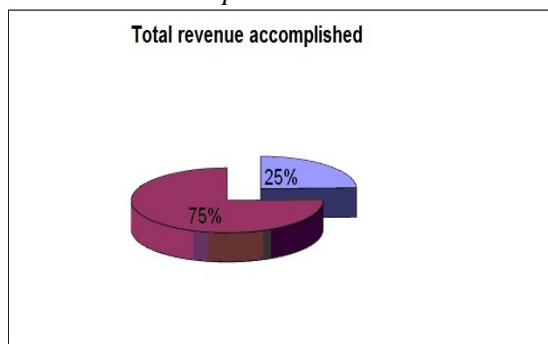

Although 93% of the total revenue in 2013 were accomplished, 96% in 2014, while 68% of current revenue were achieved in 2013, respectively 54% in 2014, reason for which the programmes included in the revenue and expenses budget programmes both in 2013 and 2014 couldn't be accomplished. During the two years analyzed (2013 and 2014), the main creditworthiness and efficiency indicators,

calculated as a result of the data kindly provided by the Accounting Department within Baraganu City Hall, are the following:

- **Unearned income UI** = Current assets / Liabilities

$$U_{I2013} = \frac{901.20}{704.60} = 1.27$$

$$U_{I2014} = \frac{967.86}{648.13} = 1.49$$

- **Solvability S** = (Liquid assets / Current assets) x 100

$$S_{2013} = \frac{698.01}{1414.47} \times 100 = 49.3\%$$

$$S_{2014} = \frac{844.11}{1543.74} \times 100 = 54.68\%$$

- **Return on equity RE** = (Gross Profit / Equity) x 100

$$R_{E2013} = \frac{196.56}{698.01} \times 100 = 28\%$$

$$R_{E2014} = \frac{300.70}{844.17} \times 100 = 35.62\%$$

- **Rate of return (r** = (Net Profit / Equity) x 100

$$R_{r2013} = \frac{151.41}{698.01} \times 100 = 21.7\%$$

$$R_{r2014} = \frac{235.26}{844.17} \times 100 = 27.87\%$$



Upon review of these indicators, the data in table 2. is the following.

Table 2. *Creditworthiness and efficiency indicators calculated for 2013 – 2014*

	INDICATORS	2013	2014
1.	CURRENT RATIO	1.27	1.49
2.	SOLVABILITY (%)	49.30%	54.68%
3.	RETURN ON EQUITY (%)	28%	35.62%
4.	RATE OF RETURN (%)	21.70%	27.87%

As noticed in the table above, the economic-financial efficiency indicators remain relatively consistent and have increased in 2014 compared to 2013. All calculated expenditure and incomes in regard to operation, were taken in consideration for the establishment of the operation result. The long-term solvency rate registers values of over 1.5, which proves that the City Hall has the capacity to pay its immediate and delayed pecuniary obligations towards third parties. The local budget can be solvable even if at some point, due to lack of liquidity it might present incapacity to pay. Solvability is generated by an efficient activity and the lack of payment capacity and liquidity, may have a temporary nature if the society is based on a general solvability.

The long-term solvability rate expresses, in relative terms, an indicator equivalent in absolute value corresponding to the asset not invested in liabilities, and that is the net statement. Based on the data taken from the profit and loss account and the balance sheet, the leverage can be highlighted in the same manner as under conditions of corporate tax absence. What customizes leverage in the presence of taxation is the calculation of remuneration rate based on profit flows and net interest after taxes.

For the minimum level stability that the working capital needs to attract the leverage must also be considered, which can orient towards another way the option between the increase of the capital through new cash inputs and a long-term indebtedness. Simultaneously, measures must be taken for the diminution of the working capital need by accelerating the inventory turnover, the reduction of the due dates granted to clients

and obtaining longer due dates from providers.

## 5. Conclusion

Taking into consideration current and perspective exigencies regarding the evolution of Baraganu City Hall rendered by analyzing the method of establishing income and expenses to the local budget during 2013 – 2014, as well as from the objective analysis of the main economic-financial indicators, this work proposes several action directions:

- Local autonomy imposes: political autonomy, economic autonomy and legislative autonomy. If from the three factors up to present, only two of them have been materialized in legislative programmes, the economic factor, which is one of the most important factors determining the implementation of programmes and projects was partially achieved from a legislative point of view, reason for which it is proposed that the totality of fiscal and non-fiscal incomes be collected in one account open at Techirghiol Treasury, following that the annual budgetary law to determine a percentage of the income reached throughout Baraganu Commune to be transferred to the state consolidate budget.
- In accordance with the regional development plan, our proposal is to elaborate projects representing the regional infrastructure rehabilitation, where Baraganu should be included, and whose financing should be provided in percentages from local funds, redistribution of funds or raised sources.
- In order to perform all internal and external activities, the Local Council must assume a series of internal tasks, which involve the management of the institution itself, such as: personnel (employment, promotion, salaries, etc.), budget preparation/ execution, accounting, tenders, income collection and management, information systems.

All in all, the general rule for the creation of value, yet remains simple. As long as the projects where Baraganu City Hall gets involved, regardless of their risk level, will have a marginal rate of return on capital exceeding the cost of the capital employed, they will further create value.

## 6. References

- [1] Androceanu, A., *Noutăți în managementul public*, Universitara Publishing House, Bucharest, 2008
- [2] Brezeanu, P., *Gestiunea financiara și politicile financiare ale întreprinderii*, FRM Publishing House, Bucharest, 2009
- [3] Căruntu, G.N., Tănăsioiu, G., Romanescu G., *Management financiar*, Brancuși Academic Publishing House, Târgu Jiu, 2014
- [4] Deaconu, A., Podgoreanu S., Rasca, L., *Factorul uman și performanțele organizației*, ASE Publishing House, Bucharest, 2004
- [5] Nica, P., Iftimescu, A., *Management. Concepte și aplicații*, Sedcom Libris Publishing House, Iasi, 2004
- [6] Nica, E., *Strategii și politici de ocupare a forței de muncă în România*, Economica Publishing House, Bucharest, 2007
- [7] Preda, M., Vasilescu, B., *Drept administrativ, Partea Speciala*, Lumina Lex Publishing House, Bucharest, 2007
- [8] Weiss, D. et. al., *Ressources Humaines*, 2ed., Editions d'Organisation, Paris, 2003

## Managerial Accountability – a Key Factor in the Implementation of Internal Control Systems

Elena Doina Dascălu

"Spiru Haret" University, The Faculty of Economics

[doina.dascalu@rcc.ro](mailto:doina.dascalu@rcc.ro)

Laura Nasta

Bucharest University of Economic Studies, Doctoral School in Economics

[alsenasta@gmail.com](mailto:alsenasta@gmail.com)

### Abstract

*Internal/managerial control is a key instrument for the implementation and development of managerial accountability in the public sector. The INTOSAI Subcommittee issued, in 1992, the "Guidelines for Internal Control Standards for the Public Sector" (INTOSAI GOV 9100), defining a control framework in this sector and ensuring an objective criterion to assess public entities' internal/managerial control systems adequacy and functionality. In this perspective, the article introduces a series of conclusions of the authors, devolving from the results of a research conducted at INTOSAI level, on public sector internal/managerial control, as well as relating to the model of the three defence lines (- operational management, - risk and compliance management, - internal audit) which aims at enhancing the way risk management and internal control are understood, by delimiting and clarifying roles and competences.*

**Key words:** *managerial internal control system, managerial accountability, risk management and control, three lines of defence model*

**J.E.L. classification:** M40, M48, O33

### 1. Introduction

*Law no. 672/2002 on internal public audit [2], re-issued, as subsequently modified and completed, defines the governance concept as "the overall processes and structures implemented by the management so as to inform, direct, manage and monitor*

*entities' activities towards attaining objectives" (see Art. 2, Letter "p"), including risk management, internal control and compliance activity.*

*Managerial accountability is an important government element in the public sector. Referring to this concept, Robert de Koning reckons that it is used not only to make managers accountable for their decisions, but also to obtain the assurance that these decisions are adequate and implemented in the benefit of the public (see [3]), keeping with well known rules and quality norms, able to detect waste, fraud and irregularities.*

*The internal/managerial control system is a basic instrument for the implementation and development of managerial accountability in the public sector, based on a direct connection between designing an adequate and functional internal/managerial control system and the managerial accountability concept.*

### 2. Good practices in the field of internal/managerial control systems development in the public sector

The internal/managerial control models acknowledged at international level (COSO, CoCo etc.) originated in the private sector, a reason why it is rather difficult to implement them in the public sector. That is the reason why *INTOSAI Subcommittee on Internal Control Standards* (INTOSAI is the International Organisations of Supreme Audit Institutions) published, in 1992, the "*Guidelines for Internal Control Standards for the Public Sector*" (INTOSAI GOV 9100), which define the control framework and provide an objective criterion for the assessment of internal/managerial control

systems' adequacy and functionality at the level of public entities (see [5]).

INTOSAI GOV 9100 was updated in 2004, so as to include new issues and, especially, significant aspects regarding ethical behaviour in the conduct of operations, fraud prevention and detection, resources protection, as well as controls pertaining to information technology.

The internal/managerial control proposed by INTOSAI is based on the following characteristics [5]:

- It is a dynamic process, which needs to be imbedded in the public entity's current activities;
- It needs to adapt to the changes emerging within the organisation;
- It should facilitate the fulfilment of managerial accountability obligation, respectively, the modalities through which individuals and public entities are held accountable for the decisions made and for the actions taken, including for public funds protection, honesty and performance;
- It should foster information and communication, key support elements to the entity's operations' management and control (management's ability to make appropriate decisions is affected by the quality of the information grounding the decision-making process);
- All personnel should receive a clear message from the public entity's management relating to the significance of the internal/managerial control and to their role within this system;
- There is also a need to effectively communicate with the entity's external stakeholders (citizens, regulatory bodies, external auditors) relating to the public entity' performance attained in the fulfilment of the competences.

Besides INTOSAI GOV 9100, also in the field of internal/managerial control system, mention shall be made of the work drafted by the Committee of Sponsoring Organisations (COSO) and by the Institute of Internal Auditors (IIA) - "*Effective Use of COSO in the Three Defence Lines Model*" [5], [6]. It embarks on providing guidance on the way specific roles and responsibilities are set in point of the internal/managerial control in the light of two known models in the field:

*Internal Control – an Integrated Framework*, issued by COSO [5] and the *Three Lines of Defence Model* issued by IIA [7].

*The Three Lines of Defence Model in the framework of an Effective Risk Management and Control* [7], [8] (IIA, January 2013) is represented in Figure 1.

This model aims at fostering the understanding of risk management and of internal control by delimiting and clarifying roles and competences.

The key prerequisite of this model is an architecture of internal/managerial control, based on three separate functional groups (or defence lines) within the framework of the organisation, respectively:

- Functions involving and managing risks;
- Functions monitoring risks;
- Functions providing an independent assurance.

*The first defence line* includes the operational management which involves and manages risks and is responsible for the implementation of corrective actions in case deficiencies are identified. This is the first defence line since it sets the way in which control instruments are designed and implemented within processes and systems.

The aim of this defence line is to provide compliance and highlight instances of control malfunction, inadequate processes or unexpected events.

*The second defence line* includes risk and compliance management functions set by the managerial team in order to monitor the control instruments established in the first defence line.

The risk management function and/or a committee with competences in this respect facilitate and monitor the implementation of effective risk management practices and assist risk holders (owners) to define risk exposure and report key data on the risk. The compliance function is implemented to monitor specific risks (financial and financial reporting ones) on non compliance with the relevant regulatory framework.

*The third defence line* refers to the assessment of the first two defence lines by the internal audit, which reports both to the executive management and to the audit committee.

Figure 1. The Three Lines of Defence Model in the Framework of an Effective Risk Management and Control

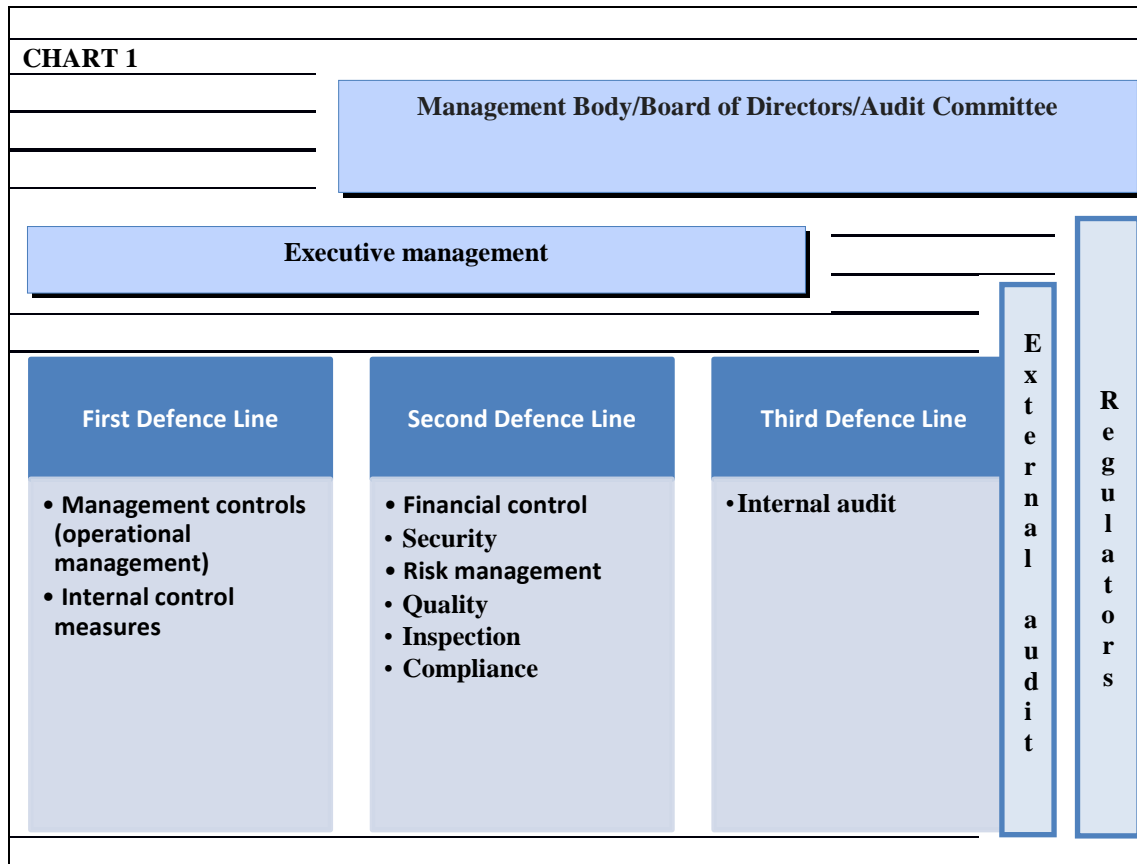

Source: [7]

The structuring of the internal/managerial control in keeping with the above model grants the prerequisites that the risk management and the internal/managerial control operate effectively within the public entity.

### 3. Current situation of internal/managerial control reporting

To update INTOSAI GOV 9100, the *INTOSAI Subcommittee on Internal Control Standards* conducted a survey (see [4]) among INTOSAI members to establish the development level of the public sector internal/managerial control reporting mechanisms. In keeping with the survey report [4], answers were received from a number of 64 Supreme Audit Institutions from around the world. The survey involved the filling in of a questionnaire which included questions on:

- legal and organisational framework for reporting on internal control;
  - scope of internal control assessment and reporting on internal control by the public sector entities;
  - assessment of reports on internal control and auditing of internal control;
  - the opinion on the revision of INTOSAI GOV 9110 – Guidance for Reporting on the Effectiveness of Internal Controls: SAI Experiences in Implementing and Evaluating Internal Controls.
- The analysis of the results obtained highlighted the following issues:

**3.1** Relating to the question "Is there a legal obligation for public sector entities to report on internal control?": 39% of the respondents answered affirmatively, 36% answered negatively, 13% mentioned that there exists a reporting obligation limited to particular aspects and 9% answered that reporting on internal control only envisages financial control (see Figure 2).

The answers to the questionnaire showed that in *more than a third* of the countries there exists a legal reporting obligation, while *in over 60%* of the countries there is no regulatory document that provides for a legal reporting obligation, certain and not limited to particular aspects. It is worth noting also that 22% of the countries chose a limited reporting obligation relating to internal control.

Figure 2. Is there a legal obligation for public sector entities to report on internal control?

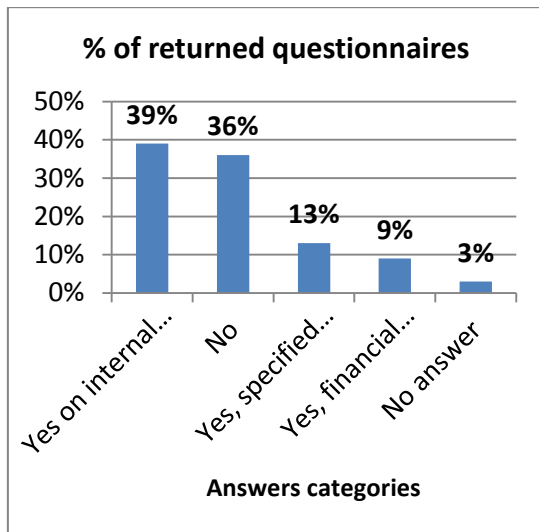

Source: [4]

(Answers categories: - Yes, on internal control; - No; - Yes, but limited to particular aspects; -Yes, but only relating to financial control; - No answer)

**3.2** As to the *legal reporting obligation relating to internal control*, the next question of the survey mentioned the type of regulatory documents at the base of (or enforcing) this obligation. The answers to this question showed that in 25% of the cases a law was issued, 28% of the respondents answered a Government Decision was passed, 17% mentioned that there is a different specific legislation (deed of incorporation), while 3% did not answer (see Figure 3).

The conclusion is that a quarter of the countries which answered the questionnaire had issued the highest ranking legislative instrument, respectively a law in the field of internal control, which highlights the

Figure 3. In what type of legislation is the legal obligation to report on internal control set out?

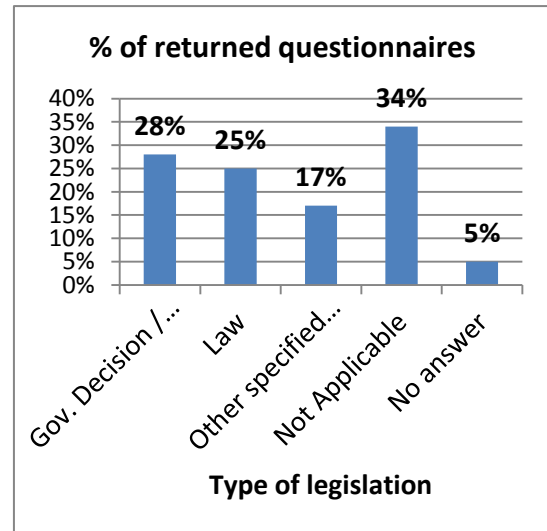

Source: [4]

(Type of legislation: - Government Decision; - Law; - Other specific legislation (statutory act); - N/A; - No answer)

importance attached to the public sector internal control in the respective country. A significant percent of the countries adopted a legislative instrument issued by the executive, respectively a Government Decision, which nevertheless has a lower regulatory power that a law.

**3.3** Another issue on internal control reporting involved the *obligation of public entities to report, according to types of entities*.

The results showed that: in a proportion of 41% all public entities had the obligation to report, 14% respondents mentioned only central public entities, while 34% answered that this was not applicable in their instance – the weight of these answers is illustrated in Figure 4. Consequently, there exists an obligation for public entities to report on internal control in over 55% of the surveyed countries, with the mention that 20% of the countries limit this obligation either to central public entities, or to specific entities.

**3.4** As to the interrogation concerning the provision for *regulation of consequences within the normative framework in case no report has been issued on internal control or*

when the latter contains unreliable data, 24% of the respondents answered affirmatively, 34% answered negatively and 34% answered that this is not applicable to them; the answers are illustrated in the chart below.

It can be seen that in 72% of the instances there is no formal sanction or clearly delineated sanction provided in case of failure to draft or in case of erroneous drafting of the report on the internal control system, which shows that fines or administrative sanctions do not represent a practice in such instances (see Figure 5).

Figure 4. What categories of entities are under the obligation to report on internal control?

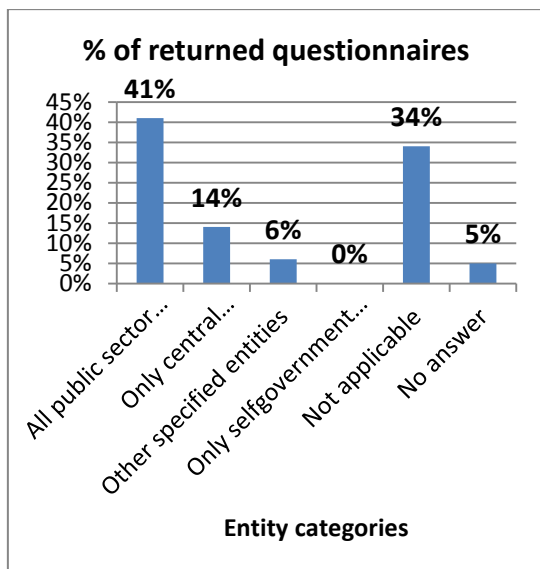

Source: [4]  
(Entity categories: - All public entities;  
- Only central public entities; - Other specific entities; - Only at local level;  
- N/A)

**3.5** The answers to the question on the provision of guidelines on how to assess internal control for public sector entities consisted of 47% affirmative answers, the rest being either negative or non applicable; the conclusion is that over 50% of the respondent countries did not issue guidance on internal control assessment, internal control being conducted in keeping with the customs of the respective public entities (see Figure 6).

Figure 5. Consequences of failure to present a statement or of presenting an unreliable statement are provided by the legislation

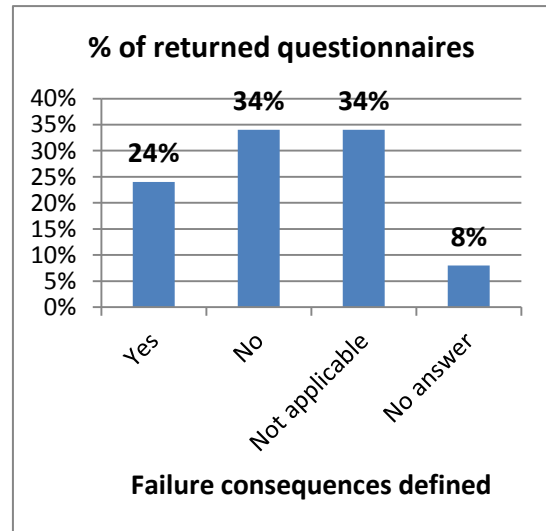

Source: [4]  
(Failure consequences: - Yes; - No;N/A;  
- No answer)

**3.6** The question on the assessment of internal control in keeping with a set of defined indicators related to internal control general objectives (compliance with the legal and procedural framework, activity efficiency and effectiveness, reporting reliability, resources protection, compliance with the ethics norms etc.) was answered affirmatively in 47% of the instances, as compared to only 6% negative answers, 47% considered it not applicable and 6% of the surveyed population did not provide an answer to it; this is illustrated in the following graphic chart (Figure 7).

In this instance, 59% of the answers indicate the lack of clear criteria against which the internal control of a public entity can be assessed.

**3.7** A significant aspect of the survey focussed on the existence and listing of methods to assess internal control in public entities.

Some 41% of the answers to this question were affirmative, by contrast with only 6% negative ones, 47% were not applicable, while 6% did not provide any answer (see Figure 8).

Figure 6. Have guidelines been provided on how to assess internal controls?

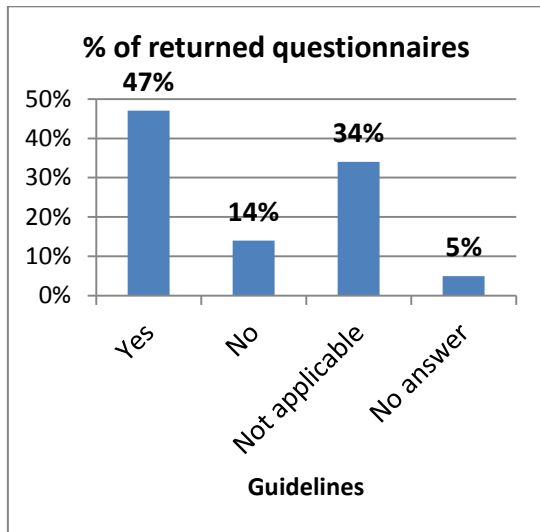

Source: [4]  
(Guidelines: - Yes; - No; -N/A;  
- No answer)

Figure 7. Is it required that the internal control assessment be conducted in keeping with a set of defined indicators?

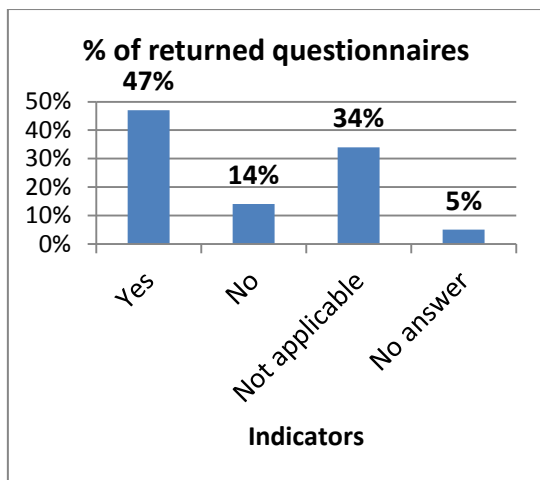

Source: [4]  
(Indicators: - Yes; - No; -N/A;  
- No answer)

In conclusion, from the methodological point of view, 59% of the countries do not have standard assessment methods relating to public sector internal control.

**3.8** The answers to the question on the existence of an internal control reporting template, with instructions (guidelines) on

how to complete it were affirmative in 27%, negative in 22%, 12% of the respondents indicated the existence of the template but with no attached instructions, 34% mentioned this was not applicable, while 6% did not answer at all (see Figure 9). It results that 73% of the countries did not draft a reporting template in the field of internal control or do not have reporting instructions.

Figure 8. Have methods been indicated for assessing internal control in public sector entities?

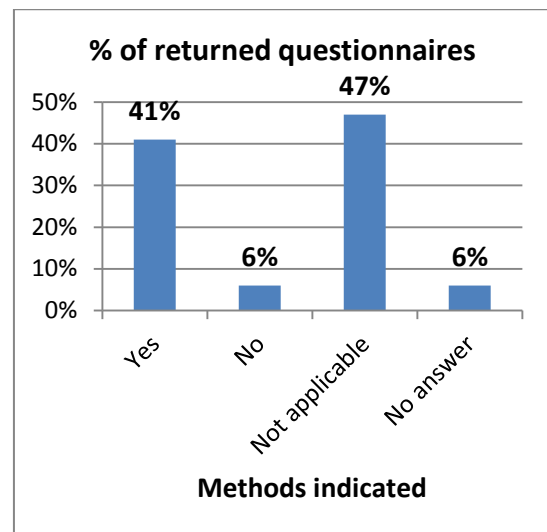

Source: [4]  
(Methods indicated: - Yes; No; - N/A;  
- No answer)

As an overall conclusion, the assessment of the questionnaire shows the need to enhance practice in the field of public sector reporting on internal/managerial control systems.

#### 4. Conclusions and proposals on the development of the internal/managerial control systems in the public sector

*The Three Lines of Defence Model* proposed by IIA is a revolution in the field of control, indicating a shift in the weight of control systems, from periodical/static controls to risk based controls, the key factor in the sizing of the internal/managerial control being the risk and not the tradition or periodicity.



Figure 9. Has a template been developed for reporting on internal control with instructions (guidelines) on how to complete it?

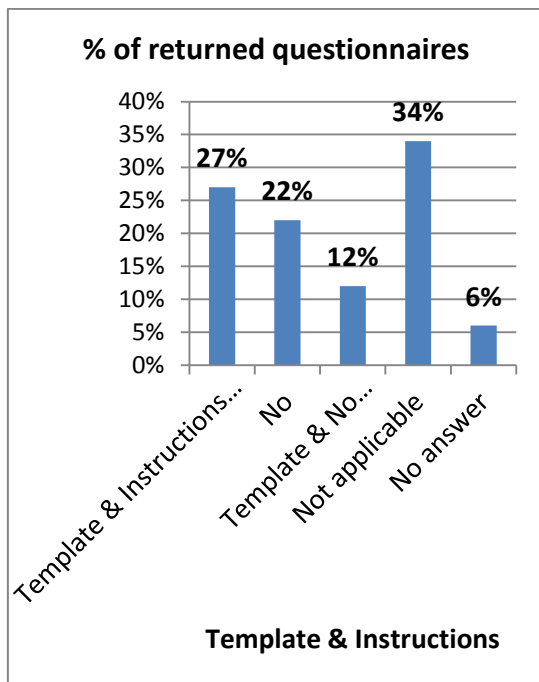

Source: [4]  
(Templates: - Yes; - No; - Yes, but without attached instructions; -N/A; - No answer)

The model highlights the need to shift internal control focus and substance, namely from being a documentary formalism to become circumscribed to the operational management needs, to fulfil the aim of the public entity; it marks the control transition from an obligation to a managerial instrument, focussed on *management accountability*.

The following development trends and proposals can be taken into consideration in the implementation of such a model in the public sector:

- enhancing the reporting system on internal/managerial control by mainly focussing on fraud prevention, efficiency, economy, effectiveness, ethics etc.;
- implementing an *adequate management reporting function* relating to internal control; this should be strengthened by a legislative instrument providing the obligation to report and clear sanctions in case of non compliance, major errors or formalism in the implementation.

- establish clear methodologies and evaluation criteria, through norms issued by the competent appointed entity;
- drafting legal provisions ruling a correlation between the annual report on the internal/managerial control system, the achievement of the public entity purposes, the managerial performance and managerial accountability, so that the mentioned report becomes a key element in the assessment of the management and in the engagement of management accountability;
- raising the importance attached to internal and external public auditors as a credible source for the independent assessment of internal control systems and, implicitly, of management performances.

## References

- [1]. Dean Bahrman - *Advancing Organizational Governance: Internal Audit's Role*, The Institute of Internal Auditors Research Foundation (IIARF), 2011.
- [2]. *Law no. 672/2002 on internal public audit*, re-issued, as subsequently modified and completed
- [3]. Robert de Koning – *Internal Public Financial Control*, 2007, pp. 55, [www.pifc.eu](http://www.pifc.eu)
- [4]. INTOSAI, INTOSAI Subcommittee on Internal Control Standards – *Research paper on reporting on internal control in the light of the results of the global survey of 2012*, June 2013, <http://www.psc-intosai.org/media/100266/>
- [5]. INTOSAI GOV 9100 – *Guidelines for Internal Control Standards for the Public Sector*, 1992
- [6]. Committee of Sponsoring Organizations of the Treadway Commission - *Internal Control – Integrated Framework*, May 2013, [www.coso.org](http://www.coso.org)
- [7]. Committee of Sponsoring Organizations of the Treadway Commission – *Leveraging COSO across the three lines of defence*, Committee of Sponsoring Organizations of the Treadway Commission, [www.coso.org](http://www.coso.org), July 2015
- [8]. The Institute of Internal Auditors - *The Three Lines of Defense in Effective Risk Management and Control*, January 2013

# Considerations on Ship Management and Current Changes in Maritime Transport

Cristina Dragomir

Constanta Maritime University, Romania

[economie.umc@gmail.com](mailto:economie.umc@gmail.com)

Simona Utureanu

"Ovidius" University, Constanta, Romania

[simona\\_utureanu@yahoo.com](mailto:simona_utureanu@yahoo.com)

## Abstract

*Managing a ship is a complex process done either by employees of a shipping company, either is externalized and delivered by a 3rd party independent companies specialized in ship management.*

*This paper presents certain considerations on developing ship management in the context of the current changes in maritime transport. Though this subject is very complex, in this paper we approach only some of the changes caused mainly by technology developments, financial crisis and, most important of all, the orientation towards sustainability and environment protection. The environmental impact of sea transport might lead to a new type of crisis with good and bad side effects.*

**Key words:** Sustainability; Greenhouse gas; International Maritime Organisation; organisational structure; crew.

**J.E.L. classification:** M10; Q25; Q53; Q58

## 1. Introduction

Maritime transport services represent a multidimensional aggregate that catalyzed and affected various aspects of human life.

From the economic point of view, maritime transport is a complex process made up of all facts, documents and economic behaviour where travel and distribution needs are met, by using the shipping capacity for physical placement of persons and cargo [1].

In business terms, a company in the shipping industry reflects a business providing a range of services in the field of

water transport, including movement of goods for domestic and external use, regardless the type of cargo or type of ship, on different routes and waterways, between different ports and regions.

## 2. What is Ship Management?

According to BIMCO (Baltic and International Maritime Council), the largest international shipping association representing shipowners, "one third of the world's fleet is in the hands of ship management companies" [2].

Regarding the understanding the term "ship management", BIMCO states that: "Ship operation is increasingly a specialised and technical business, which is often these days undertaken by specialist ship management companies. These, typically will not own the ships themselves, but will contract to operate them, manage and maintain them, and provide the detailed technical management to keep them operating efficiently". [2]

In 1988, withal the UK Parliament was amending the Merchant Shipping Act, BIMCO association was formulating a first form of a standard ship management agreement [3]. In 1998, BIMCO published a reviewed sample model for the Standard Ship Management Agreement, named "Shipman 98", intended for use on a world-wide basis. According to this basic agreement, the Owner of the ships agrees with the ship managers/ a ship management company regarding several components of ship management: crew management, technical management of ships, commercial management (freight management, chartering and operation), insurance management,

accounting services, sale or purchase of the vessel, provisions, bunkering (fueling).

In 2009, BIMCO released "Shipman 2009", a reviewed version of the previous reviewed "Shipman 98". The newest version, among other things, emphasizes the Shipman agreement as being, foremost, a technical management agreement, though including other services as general administration that has to be delivered by the managers under the agreement, as well as other several free-standing clauses.

### **3. Current changes in Ship Management**

This paper has the aim to trigger a review on a few aspects of changes in ship management, only. The actual situation of ship management is more complex, in the context of the current dynamics in world economy and changes in shipping business. Some of the changes manifested in shipping business are partially reflected in the changes brought by BIMCO ship management model agreements, the versions from 1988, "Shipman 98" and "Shipman 2009". The latest "Shipman 2009" emphasizes the developments in the industry, including the coming into force of two of the most known regulations in the sea transport: ISM and ISPS Codes. Nevertheless, the authors of this paper do not intend to discuss the effects of such regulations, but the effects of other changes in the world dynamics affecting the industry, like technology developments, financial crisis and the eco-friendly user orientation in shipping.

#### **3.1 Changes in technology determined changes in ship operation and crew management**

The evolution of sea transport was slow and always full of dangers. The personnel who work on sea lack the advantages of an employee working on land. Worldwide, major shipping companies have adapted several requirements for a modern ship management based primarily on personnel excellently prepared. The results were outstanding and led to financial results that have increased the development of maritime transport in practice.

According to source [4], in the early decades of modern navigation, before 1930s

cargo ships had their own management due to the lack of means of modern communication between the ship owner on land and the personnel on sea. The owner had no other option than to entrust the entire ship to the master until the ship was returning to the nearest port. In such conditions, the master was taking any decisions on the best use of the ship, including those relating to the seafarers employment.

As communication systems have developed, the ships became easier to exploit and so, much of the technical and operational decisions passed from ship master to ship owner's office. Since the 1970s, the owners revised their attitudes about the management system used, due to market conditions at that time. The change was influenced by higher operating costs, lower freights, generic competition and the entry of other nations in the shipping sector. There also occurred difficulties in retaining sea personnel because voyages were very long and seafarers were no longer satisfied with life at sea. Desiring to be near their family, many seafarers gave up their career for a career on shore. In such hard conditions, the first impulse of owners was to decrease freight rates and to reduce costs in order to adapt to the new market situation. This situation led to excessive centralization and meant more crew reports, more guidance and more restrictions. During this period, among other things, was reconsidered the dock frequency, making stocks and orders launch for supply spare parts and on board consumables. Also, the owners reduced crew costs by reducing the number of crew members, leading to a deterioration of the technical condition of the ships and to unions' protests against jobs cutting for their members.

Regarding the activity carried on board it was considered that the number of crew members could be reduced from 40-45 crew members to approximately 20 crew members, if the work was done either by implementing more efficient work methods or/and by introducing better operating equipment and advanced ship technology. Some maintenance activities were reconsidered and the very high consumption of spare parts and equipment was reduced. Subsequently, the International Maritime Organization's (IMO) new technical and operational improved the crew and ship structure. The new systems

urged for efficient cooperation between different on board departments and between the on board crew and land staff.

There were further considered a series of social problems on board, due to the poor job satisfaction. Alcoholism was a possible consequence of the lack of incentives and of too much free time on board. After conducting various courses and seminars it was found that the on board personnel strongly requested more information available, more involvement and more responsibility from the land staff.

In the case of very large companies there were created multiple streams of information between the on shore departments and the ones on board ships, which led to confusion and erroneous transmission of information. Some companies have solved this problem by introducing a coordinator that has as main task to ensure effective communication between ship and shore departments. Other companies have considered a more evolved matrix structure of the organization, through which ship's departments could communicate both with on shore departments and with the ship manager.

The problem of insufficient transmission of information to managers on board was difficult not due to technology constraints, but was caused by the fact that there were not permanent crews on ships [4].

Today, thanks to technological advancements in communication and ship operations, a period of 4-6 months of international travel is considered to be acceptable. This solution has been adopted to encourage crew members to stay longer in the field and was followed by the introduction of rest periods of up to 50% time spent at sea. Some shipping companies went further and request only 1 or 2 months period work by sea (on board ship or on oil/gas platforms) followed by successive rest periods on shore, though this work schedule might be a benefit dedicated to senior crew members, only.

### **3.2 World financial crisis determined changes in shipping business**

In our days, the business of maritime transport expanded vertically, and many other types of business emerged on the market platform of sea transport, many of

them connected directly or indirectly to water transport. Beside the shipping companies transporting cargo or passengers by sea effectively, the maritime industry is quite complex and includes many other businesses connected directly or indirectly to the shipping business: ship building companies, ship/platform repairing companies, bunkering companies, shipchandling companies, ship agent companies, ship pilot companies, crewing companies, ship management companies, legal and/or financial advisors companies, surveyor companies, insurance companies (including P&I clubs), educational institutions (academics, college and training centres) and others. A distinct shipping "affair" is developed by non-profit governmental and non-governmental organisations and institutions, which main function is to establish a common legislative framework for a safe and high quality ship transport service.

The organizational structure of shipping companies varies considerably from one sector to another within the navigation industry. In the shipping business, the largest companies with significant number of ships, capable in buying and operating newest ships with cutting-edge technology and providing a high quality transport service at suitable costs are stock companies, while usually the family business in maritime transport, with older or second hand ships, remained on the market under the form of limited liability companies.

In such industry, banks and financial institutions are playing a major role. After the financial crisis, the involvement of private financial institutions in shipping declined. Bank lending continue to be "the prime source of capital in the building of new ships, buying of second-hand ones, providing working capital when bridges are needed and restructuring misjudged historic loans" [5].

Though, in 2000's, "the actual number of banks involved in ship finance constantly varied and it was not unusual for one bank to sell its ship loans portfolio, either in whole or in part, to another bank. Estimates in the late 1990s suggested that worldwide there were some 40 banks involved in ship finance, of which about 70 per cent were European, 18 per cent United States and 10 per cent Asian"[5], and, if "until the financial crisis most shipowners could borrow enough from

banks to cover \$7 out of \$10 towards the cost of buying new ships", since the time of crisis (2013), "banks are now unlikely to lend much more than half – even to shipowners with very strong balance sheets" [6].

### **3.3. Environmental constraints determined changes in regulations and business operation**

In the opinion of the authors, the latest and most important constraint for shipping business and for ship management, due to long term serious effects and mass impact, is not the financial crisis, but the environmental issues raised by water transport.

In order to support this idea and also to illustrate a fair image of sea transport, it is just to balance the advantages and the disadvantages of this mean of transport.

Certainly, sea transport has several key advantages compared to other modes of transport. Firstly, it is considered the most economical transport cost calculated either globally or per transported tonne, especially when is an expressed in tonne / mile. This advantage stands out on long distance, overseas, especially if we consider that our planet Terra is also called The Blue Planet due to the large proportion of oceans and seas water, compared to land surface. Secondly, maritime transport has a wide range of ships, conventional or specialized, with capacities ranging from a few hundred deadweight tons (dwt) ore carriers to bulk carriers of above 300,000 dwt or oil tanks of over 500,000 dwt. Such capacities allow to transport in only one trip large quantities of cargo at distances of thousands nautical miles without stopping from the loading port at intermediary ports, until reaching the destination. Thirdly, sea transport allows the transport of cargo globally, almost on any geographic point, including in areas with ice, without transshipment, customs and other operations, under increasingly better safety, compared to the distances to be covered. Also, maritime navigation requires relatively low and minimal infrastructure investments compared to land transport which requires significant financial governmental involvement in construction of roads, highways or railways. Maritime transport also allows cargo concentration in major international seaports, allowing further

transport by land to any destination inside the continental areas. Through multimodal transport, cargo of all kinds is radially spread from such major ports to destinations, by road, air or rail, or, efficiently, by rivers or waterways [7].

Obviously, as we previously mentioned, an accurate image of maritime transport can only be achieved after considering also its disadvantages. Although business investors share distinct economic purposes and interests, there are some major disadvantages of water transport that can easily overbalance the positive aspects enlisted above, and therefore should be taken into consideration, namely: the speed of the transport and the environmental impact. Though, it is worth mentioned that there can be found plenty solutions to address each of them.

Indeed, maritime transport is far the slowest mean of transport compared to others means. Due to up to-date technological constraints, commercial ships' speed varies from 5 to 25 knots, which approximately equals to 9- 47 km/h. Non-commercial ships can reach speeds of above 35 nods, eq. 65 km/h. Either way, ships' speeds are less than the legal maximum highway trucks and rails. Though the ship speed depend on the ship technology, it is important to consider that many ship owners insist to plan a commercial voyage at economical speeds of 5-10 Nods in order to keep under control the bunker (fuel) costs, as well as gas emissions, though their ships are designed to reach higher speeds. For example, "Maersk, the world's largest shipping line, with more than 600 ships, has adapted its giant marine diesel engines to travel at super-slow speeds without suffering damage. This reduces fuel consumption and greenhouse gas emissions by 30%. It is believed that the company has saved more than £65m on fuel since it began its go-slow" [8].

Regarding environmental impact of maritime transport, it is a real fact that ships pollute not only seas, but air as well with emissions of greenhouse gases. A first legislative measure taken by IMO (International Maritime Organization - the United Nations specialized agency with responsibility for the safety of shipping and the protection of the marine environment) in reducing air pollution from is dated from 1978, when MARPOL International

Convention for the Prevention of Pollution from Ships from 1973 was updated with Annex VI as modified by the Protocol of 1978.

In 1998, IMO's Marine Environment Protection Committee (MEPC) at its 42<sup>nd</sup> session "considered the submission by the United States (MEPC 42/9/2) which provided estimates of the global emission for six specific pollutants developed by the Department of Engineering and Public Policy at Carnegie Mellon University, Pittsburgh, Pennsylvania, and noted that, based on an analysis of Lloyd's shipping data and global bunker fuel sales, the estimated CO<sub>2</sub> emission from ships is approximately 2% of the global CO<sub>2</sub> emission and a small but significant source of the total global emissions. (...) Increase in seaborne trade generally results in a corresponding increase in CO<sub>2</sub> emission, but analysis of the relationship between CO<sub>2</sub> emission and world seaborne trade indicates that, since 1990, there has been a definite trend towards reduction in ships' CO<sub>2</sub> emission per tonne-mile of world seaborne trade"[9]. Taking into consideration the same statistics, a study to IMO for the same Marine Environmental Protection Committee in 2000, delivered by an international consortium stated that "Shipping is a small contributor to the world total CO<sub>2</sub> emissions (...)This implies that a 10% reduction in emissions from shipping represents less than 0.2% reduction of the world total emissions [10]". Further, considering such statistics, many governments including the Russian Federation [11], several United Nations institutions and the EU, decided not to include shipping emissions in their national estimates for CO<sub>2</sub> emissions [12].

Shipping pollution figures are striking contradictory. The 2000 IMO GHG study [10] estimated that "in 1996, ships contributed about 1.8% of the world's total CO<sub>2</sub> emissions, and clearly stated that there is no other mode of transport with a better CO<sub>2</sub> record in specific terms" and this GHG Study was considered in 2008 by the Great Britain Parliament as being "the most comprehensive assessment to date of the contribution made by international shipping to climate change" [13]. But in the same year 2008, a report of the UN's Intergovernmental Panel on Climate Change (IPCC) revealed that the true

scale of climate change emissions (CO<sub>2</sub>) from shipping was of 1.12bn tons of CO<sub>2</sub> each year, nearly 4.5% of all global emissions of CO<sub>2</sub>— almost three times greater than previously believed, compared to the aviation industry which is responsible for 650m tons/year - over half of the amount of CO<sub>2</sub>. Previously that date, the UN's Intergovernmental Panel on Climate Change estimated shipping emissions were of maximum 400m tonnes [12].

As oil continues to be the key resource in transport, the lowering level of oil price impacts all types of transports, including sea transport. In World Bank's latest commodity update from 2015, the financial institution "is lowering its forecast for crude oil prices from \$57 per barrel in its July report to \$52 per barrel. The revised forecast reflects a further slowing in global economic performance, high current oil inventories, and expectations that Iranian oil exports will rise after the lifting of international sanctions" [14]. But in our opinion, a decisive impact on lowering the oil price will be the change of the demand primarily manifested by the end user consumers, especially after the 2015 Volkswagen scandal.

#### 4. Conclusions

Ship management is the particular management service that provides a complex management related to the supply of crew (crewing management), technical management (monitoring of the hull, the engines and the equipment of the ship) and commercial management of a ship (freight management, chartering and operation), insurance management. A concrete definition of ship management is given by the international model of Agreement on Ship management, SHIPMAN of the Baltic and International Maritime Council (BIMCO).

In the context of the current world dynamics in shipping, some of the changes manifested in shipping business are partially reflected in the changes brought by BIMCO to the latest ship management model agreement, "Shipman 2009".

Significant changes in shipping are reflected by developments in technology, financial crisis that affected shipping business and the eco-friendly user orientation

in shipping, which is by far the change with the highest impact.

In our opinion, the environmental consciousness will lead the way to a new type of crisis, partially, but not entirely, mirrored, and in the same time tailored, by the drop of the oil price that definitely affects directly and indirectly many sectors and various businesses from different industries. But, although we consider the side effects, we state that good things can and will happen after any crisis. Crises don't mean necessarily something entirely bad. On the contrary, every crisis leads the way to important improvements and effective configuration and for sure many improvements in shipping yearn to appear.

## 5. References

- [1] Mircea, I., Popa, C., *Maritime Transport Economics (Economia transporturilor maritime)*, Tribuna Economică Publisher, Bucharest, 2002, p.12.
- [2] [https://www.bimco.org/en/Education/Seascapes/Questions\\_of\\_shipping/2009\\_01\\_09\\_What\\_is\\_3rd\\_party\\_ship\\_management.aspx](https://www.bimco.org/en/Education/Seascapes/Questions_of_shipping/2009_01_09_What_is_3rd_party_ship_management.aspx), accessed at 1.10.2015
- [3] Branch, A. E., *Elements of Shipping*, 7<sup>th</sup> edition, Routledge Taylor & Francis Group, UK, 2005
- [4] Bătrîna, G., *Marketing și management naval*, Cartea Universitară Publisher, Bucharest, 2004
- [5] International Labour Organization, *The impact on seafarers' living and working conditions of changes in the structure of the shipping industry*, Report for discussion at the 29th Session of the Joint Maritime Commission, JMC/29/2001/3, Geneva, p.9.
- [6] Odell, M., Mangan, A., "Wave of private equity money flows into shipping", *Financial Times*, 27.10.2013, available at <http://www.ft.com>, accessed at 1.10.2015
- [7] Popa, C. C., *Naval Management (Managementul transporturilor navale)*, Mircea cel Bătrân Naval Academy, Constanța, 2011, p.7-8.
- [8] Vidal, J., "Modern Cargo Ships Slow to the Speed of the Sailing Clippers", *The Guardian*, 25.07.2010, available at: <http://www.theguardian.com/environment/2010/jul/25/slow-ships-cut-greenhouse-emissions>, accessed at 05.10.2015
- [9] IMO, *Report of the Marine Environment Protection Committee on its Forty-Second Session*, MEPC 42/22, 16.11.1998, p.33-34, available at [http://crs.hr/Portals/0/docs/eng/imo\\_iacs\\_eu/imo/mepc\\_reports/MEPC42.pdf](http://crs.hr/Portals/0/docs/eng/imo_iacs_eu/imo/mepc_reports/MEPC42.pdf), accessed at 05.10.2015
- [10] Henningsen, R. F. (coord.), *Study of Greenhouse Gas Emissions from Ships*, Issue no. 2 – 31 March 2000, issue no. 2, 31.03.2000, MT Report: MT00 A23-038, Trondheim, Norway, March 2000. p.9.
- [11] IMO, *Information on CO<sub>2</sub> Emission from Marine Transport of the Russian Federation*, MEPC 42/INF.28, available at: <https://imo.amsa.gov.au/public/1998/mepc42.html>
- [12] Vidal, J., "True scale of CO<sub>2</sub> emissions from shipping revealed", *The Guardian*, 13.02.2008, available at <http://www.theguardian.com/environment/2008/feb/13/climatechange.pollution>, accessed at 03.10.2015
- [13] Environmental Audit Committee of the UK Parliament, *Reducing CO<sub>2</sub> and other emissions from shipping*, 4<sup>th</sup> Report of Session 2008-2009, IMO Study on Greenhouse Gas Emissions from Ships, House of Commons, Great Britain Parliament, 28.10.2008, p.21.
- [14] World Bank Group, *Commodity Markets Outlook*, World Bank, Washington, DC, October 2015, available at <https://openknowledge.worldbank.org/handle/10986/22786> and <http://www.worldbank.org/en/news/press-release/2015/10/20/world-bank-revises-down-forecasts-for-oil-prices-other-key-commodities-in-2015-and-2016>
- [15] Kwiatkowska, B., Dottinga, H., *International Organizations and the Law of the Sea: Documentary Yearbook*, Rijksuniversiteit te Utrecht, Netherlands Institute for the Law of the Sea, 2000

# The Need for Consumer Protection in the Consumerist Society

Gabriela Gheorghiu

„Ovidius” University of Constanta, Faculty of Economic Sciences  
[gabrielag3110@yahoo.com](mailto:gabrielag3110@yahoo.com)

## Abstract

*In order to better understand the importance of the intervention within the market in favor of the consumer, and also the mechanisms by which it can be effectively implemented, the present paper presents the historical and social context of the assertion of the need for consumer protection and its evolution due to the development of a consumerist society.*

**Key words:** consumerist society, consumer interests, consumer protection

**J.E.L. Classification:** D18

## 1. Introduction

The idea from which we start in the present paper is that of modern consumer regarded not as an isolated individual, who does shopping in vain, but in his capacity of participant in a contemporary phenomenon often named as consumerist culture, which characterizes *consumerist society*. Asserting about an individual that he is a representative of consumer culture assumes that he adopts a consumerist attitude, in the sense that he permanently feels the need to consume more and more, the purchase of new products offering him satisfaction and sense to his life to a great extent.

In principle, the concept of consumerism marks the appearance of a new specialization in the process of dividing the occupations, respectively the “consumer” profession – that supposes the use or consumption of products or services by a person, which replaces the “buyer” one – which involves the presentation, acceptance and payment of a price by a person on purpose to purchase a product or service he may use or not, as he wishes. Moreover, this concept describes the legitimization, the enactment of consumer rights and their entrance in the area of

interests of the producers, law courts, attorneys, regulation and legislator bodies, consumers’ unions etc.

## 2. The appearance of consumerism

From the historical point of view, the appearance of consumerism is intimately tied to the creation processes of mass markets, industrialization and the formation of an attitude oriented toward the use of the increasing incomes of the population for purchasing a higher and higher production.

Looking back on time path, the situation appears to us as a powerfully contrasting one to that of nowadays, because almost no one, in no country of the world, lost time and spent his resources for purchasing goods which were made too far from the place where he had his residence.

Before the industrial revolution was produced, the large majority of the population of each country was living in rural areas and was occupied with the agriculture. Everything that individuals had and used in the house, including their own accommodation, was the result of the household members work or of different handicraftsmen from the village in which they cohabited with the other locals and expected to last for a life time. The main preoccupation for them was not to famish. And as the wherewithal, in most of the cases, were the result of their own production, they knew very well the products made and used in the household. In spite of that, there was also small elite, who enjoyed a high level of living, buying on a regular basis luxury goods produced by few artisans and merchants, concentrated around the commercial centers of every country.

During this period, there could hardly be about a consumer protection under any form, the only cross-references of this type being found for example in the Holy Bible, where the use of false weights and measures that



could be used for fabling or cheating on fellow humans in the transactions developed with them was denounced repeatedly: "Ye shall do no unjustly in judgment, in line, in weight, or in measure. Your balance must be fair, the weights fair"[1] or "The weights for your balance be true and fair...because who does crookedness is horridness in front of the Lord"[2].

Also, ever since the ancient times we find in old writings clues concerning the presence within the markets in Athens, since Pericles, of some inspectors denominated "agoranons", whose mission was that of evaluating and checking the quality and uniformity of bread, the weight and freshness of fish, the freshness of fruit and vegetables offered for sale, these being considered as indispensable products for satisfying people's need for food.

### **3. The assertion of the need for consumer protection**

A tangible form of consumer protection can be identified for the first time in the Roman law. Thus, since the Law of the Twelve Tables, at the beginning of Roman Republic, the buyer could ask for a solemn statement from the seller which specifies the essential qualities of the sold object, statement which assumed a commitment on his part with regard to the correctness of what was stated, any untrue statement in relation to the traded merchandise being prohibited to him.

In the 2<sup>nd</sup> century BC, the magistrates in charge with market police and jurisdiction in the contracts signed in those places, denominated "aediles curules", imposed to slave traders to disclose to the buyer specific established vices, or he was enabled to require the annulment of the sale and the restitution of the paid price. The creation of aediles curuli, very resembling to the legal institution of the vice practiced nowadays and regulated by the Civil code, was extended in other places than the market, as the situations in which the object of the sale was other than a slave or an animal, being generalized at the end of the post-classical period, as an expression of the interdependence of seller's obligations with the buyer's. This, however, did not suppress the manifestation of fraud in practice, reason

for which numerous cases of counterfeit wine traffic were known, wine whose taste and color were altered by the use of aloe.[3]

Middle Ages mark the appearance of more elaborated techniques for consumer protection, which did not aim at traders' abuses, but regarded his protection of sub-consumption risk, the fear of starvation clouding the life of the civilization in those times.

Even if the great international or interprovincial trade was still in an embryonic stage, local trade knew a real upsurge, each town having to assure all the products and services necessary to its inhabitants, rarely appealing to distant exchanges. As a matter of course, commercial upsurge was accompanied by the multiplication of abuses, from watering down the milk and the counterfeit of wine, to the sale of hemp threads instead of linen threads and the trading of shoes made out of dog leather burnt in the sun as tanned skin.

Also, during this period the weights and measures represented the most reliable aids of the trader on purpose to appropriate to himself undeserved benefits. Under these circumstances, the consumer started to complain, so that the more and more obvious and abundant abuses imposed to the medieval society to organize in order to search for remedies and to institute a protection system for the consumer's economic interests.

In a first phase, the answers found to this problem concretized in blaming by church - whose influence and especially interference in social life was determinant in those times - the trade actions which came in conflict with the aforementioned biblical precepts. However, in proportion as trade intensified beyond the control power of the church, and the possibilities of material gain became considerable, church authorities went from the condemnation of any alienation form of the goods for money, to the acceptance of this activity on condition of its realization on purpose to satisfy the needs of the society and not for personal benefit. Consequently, the church imposed the rule of practicing the right price, which will dominate the relations between consumers and traders during the following centuries.

The one which definitively transformed the production, and not only it, by leaving its mark inclusively on the consumption, was

the industrial revolution, which determined the unprecedented increase of national production, but which was not accompanied by a corresponding evolution of the consumption, so that a great part of autochthon production came to be traded abroad. Moreover, during the 19<sup>th</sup> century, both middle class, situated in full swing, and the working class started to manifest in the capacity of consuming classes, their members becoming more and more interested in increasing the gained income, especially through work, in order to spend and consume more and more to their personal interest.

#### **4. The new consumerist society**

In this social and economic context the first institutions for the support and promotion of mass consumption came to prominence. Thus, in the big cities in England, France and the United States of America a series of commercial shops under the form of mid-public comfortable spaces in which the consumers could contemplate various categories of products, were open; at the same time, new packaging technologies developed, facilitating the distribution of commodities in bags, boxes and bottles; advertising activity experienced a real boom; the institutions for granting consumption credits developed. In parallel, modifications on the way in which households in general were perceived and the place occupied by women within them and especially in the society, took place. The balance between private and public consumption was also affected, the latter going from strength to strength as a consequence of the massive investments for the development of public infrastructure intended to support the consumption activity.

The radical difference between the consumers belonging to new consumption society and the consumers from previously known societies is mostly remarked, the existence of the first ones being marked by the replacement of the old dilemma "we work to live or we live to work ?" with a different one, respectively "We need to consume in order to live or we live to consume"[4], because it became more and more difficult, if not impossible, the separation of daily life from the consumption activity.

We can observe from this historical enumeration of the events the exclusive preoccupation for encouraging the expansion of consumption intended both to satisfy consumers' needs, on one hand, and to realize producers' interests, on the other hand, completely neglecting the qualitative aspects connected to it.

In the severe fight between producers on purpose to gain more clients, they did not always appeal to the most correct practices, so that the concern for the quality of the offer did not represent a goal of production, but rather the maximization of production at low costs guided the producers in their activity, feeling certain that the price represents the main reason based on which the purchase decision is adopted by the consumer. As a matter of fact, economic theory focused in this period on the emphasis of the role of the competition developed between the producers on purpose to guarantee the best prices for the consumers. Even the acceptance of public power intervention in economic activity was prevalently connected to the supply safety of the products which were absolutely necessary for living, as bread or milk, at accessible prices, especially during the shortage periods, but also to a loyal competition as a means for supplying competitive prices during the periods of economic boom.

#### **5. The real consumer protection**

The diversification of production, generated by technological progress, allowed the invasion of the market with a multitude of products which often put the consumer in the position to choose not necessarily for exclusively "rational" reasons, in terms of the prices of the products and their utility. As a matter of fact, consumption decisions started to be less connected to strictly existential needs, and more connected to individuals' tendency to gain a specific social status, luxury replacing the humble comfort as a more outspread among the consumers.[5]

Consequently, governmental authorities everywhere in the world became aware that, in order to support the process of economic growth and not to lose in vain all the progresses obtained in the field of technology and productiveness, the cultivation of consumer trust for engaging in the

development of economic transactions was imposed, by supplying the support they needed in their favor. Although the answers to this new challenge were different from state to state, starting with 1960s and especially during 1970s, the actions intended for consumer protection knew the greatest success, their intensification being purely incredible, definitely advancing many of the rudimentary systems developed in 1930s and 1940s, and replacing almost totally the regulations adopted at the end of the 19<sup>th</sup> century, which are obsolete now.[6]

The last decades of the 20<sup>th</sup> century brought to the fore new challenges in relation to people's health ("mad cow" disease, the effects of using genetically modified organisms, bird flu), whose threat was amplified under the incidence of the process of international trade liberalization and intensification, which disseminated unfair commercial practices and especially consumers' problems beyond the national borders. During this period, warning signals appeared more and more frequently, signals which could no longer be ignored and imposed the adoption of categorical measures in order to guarantee the consumer his role as a co-participant in the market game, with equal rights. But this time the answers could no longer be singular because, since the economic activities were interrelated at global scale, the same should have happened with the actions for consumer protection, so that they could act freely and trustingly on the market.

## 6. Conclusions

The internal logic of functioning of market economy, approached from the perspective of the interests and motivations of the consumers in economic activity – producers and consumers, points out the fact that they are in an out of balance proportion, objectively, at the expense of the latter, even if the consumers, with their needs and necessities, should represent the origin and at the same the final point of the production activity. The existence of the "sovereign consumer", invoked by the supporters of free market, is jeopardized within the context of economic reality, by the failure of the action of spontaneous self-adjustment of the market, which, despite the fact that in many situations

it is possible and desirable, in many others it demands the deliberate intervention of public power towards the diminution of this relation which is unfavorable to the consumers up to an acceptable sustainability level.

Accordingly, the development of consumerist society placed in the center of political speeches the nature of consumers' identity. The adequate modality for treating them as economic actors or political actors, their approach as an independent group of interests or, on the contrary, an unorganized assembly of discontent individuals with regard to the traded products – represented dilemmas which upset the political class in modern society and to which the solutions did not fail to appear, taking various forms, depending on the role assigned and undertaken by the consumers in the economic and social life of every country.

## 7. References

- [1] \*\*\*, *Holy Bible*, the "Old Testament", "Leviticus" (third book of Moses), Chapter 19 – "An explanation of commands", verses 35 and 36, Ed. Institutului Biblic și de Misiune al Bisericii Ortodoxe Române, Bucuresti, 1991, pg. 137
- [2] \*\*\*, *Holy Bible*, the "Old Testament", "Deuteronomy" (fifth book of Moses), Chapter 25 – "Invigilation measures", verses 15 and 16, Ed. Institutului Biblic și de Misiune al Bisericii Ortodoxe Române, Bucuresti, 1991, pg. 222
- [3] Bihl, L., Willette, L., *Une histoire du mouvement consommateur. Mille ans de luttes*, Aubier Montagne, Paris, 1984, pg. 16
- [4] Bauman Z., *Globalization and its social effects*, Ed. Antet, Filipeștii de Târg, 2005, pg. 80
- [5] Schor, J., *The Overspent American: Upscaling, Downshifting, and the New Consumerism*, Basic Books, New York, 1998
- [6] Hilton, M., "Consumers and the State since the Second World War" in *The Annals of the American Academy of Political and Social Science*, Vol. 66, no. 611, 2007, pg. 71
- [7] Gheorghiu, G., *Consumer Protection – Worthlessness or Necessity. Consumer protection rationales*, Ed. LAP Lambert Academic Publishing, Saarbrucken, 2012.

## Quality Management in Healthcare Systems

Adriana Grigorescu

*National University of Political Studies and Public Administration*

[adrianagrigorescu11@gmail.com](mailto:adrianagrigorescu11@gmail.com)

Elena Condrea

*Ovidius University from Constanta*

[elenacondrea2003@yahoo.com](mailto:elenacondrea2003@yahoo.com)

Christopher De Freitas Bradley

*Valahia University of Tărgoviște*

### Abstract

*Quality management within health care systems offers a structure which can provide assistance for clinics/hospitals in order to consolidate relations, interconnect, observe, and subsequently improve all facets of healthcare management.*

*Quality management offers proof in order to support the plan that a structured organization is essential in attaining health care services of high quality, which can ultimately result in lesser health care expenses.*

*Recent studies have evidently defined two main areas in the efficient management of quality:*

- 1) Low levels of Productivity;*
- 2) Unused Quality; where healthcare quality of high standards can result in significantly lower charges.*

*Quality can openly address the most important requirements of each group, achieve a balance of partnership amongst healthcare providers, physicians, and patients, and ultimately permit the healthcare delivery system to efficiently acknowledge the standard of quality in a very demanding setting.*

**Keywords:** Quality management, healthcare management.

**J.E.L. Classification:** I18, M19

### 1. Introduction

Economically centered efforts to limit healthcare costs and price competition (for example discounts offered by hospitals to

insurance companies, and additional strategies for healthcare services) have conveyed a collective level of pricing to most healthcare service providers. Due to this fact, the next level of focus will inevitably move towards quality, and any upcoming rivalries will be primarily founded on noticeable superiority in the quality of services offered. The clinical outcome and delivery of quality will be significant.

The search for a higher standard of quality delivers a balanced structure for cost control. The healthcare business has been exposed to external pressures when in reference to cost, the key mechanisms of the healthcare system; physicians, hospitals, and insurance companies have followed contradictory objectives with a high rate of incidence. This matter has ultimately resulted in an augmented friction within the healthcare industry, and subsequently a sub-par ability to resolve more serious complications (Rose, 2005).

As a result of the external pressures which we as a community face, the healthcare system is concentrating an excessive amount of its energy on in-house discrepancies.

### 2. Improving healthcare delivery using quality management

#### 1. *An efficient portrayal of quality.*

Although there are numerous methods available to comprehend quality, there are methods set in place based on a philosophy of quality management which is known as the constant improvement of quality. There are specific reports from implementing such methods which can be beneficial for the reason that, they noticeably define the

association between cost and quality, as well as resulting in a structure for an organized control of quality or cost. They demonstrate, in what manner the search for a higher standard of quality in healthcare can result in significantly lower costs in the delivery of healthcare services.

By applying this philosophy, we may view quality along these lines: The health care system is a sequence of intertwined processes, which separately result in multiple outputs. Each individual's perception of quality is represented by their subjective assessment of an output as well as the individual exchanges that occur at the moment of output delivery. The expectations of individuals are based on previous experiences and desires. Therefore, there can arise quality evaluations as part of a value system which can be monitored and altered over time from learning.

The two main components of quality are delivery and content. The quality of delivery reveals the interaction between the patient/customer and the health care system. In doing so there are a few aspects these individuals tend to notice when visiting a hospital/clinic; firstly, cleanliness is a very important characteristic, then there would be the level of responsiveness and information offered by the staff, finally the prompt delivery of services executed with professionalism.

The quality of content is based on achieved results. It used to be the role of physicians or health care professionals to judge the quality of content, nowadays patients and customers are playing a more active part in the assessment of health care delivery.

## 2. *Quality-Cost association.*

There are five distinct ways in which quality can relate to cost:

### a) **Low levels of productivity**

Takes place as soon as two processes create an identical chosen output, however in order to achieve this action, one process consumes more resources than the other.

### b) **Unused Quality**

Unused quality signifies the necessary funds in order to repair the output of a process in the event of output discard or quality failure. Furthermore, quality failure includes costs associated with poorly managed businesses as well as time spent

dealing with disappointed clients rather than dealing with managerial obligations.

### c) **Cost versus Benefit**

Deals with the notion of maximizing versus optimizing, for example, if the addition of a new care unit results in hardly any benefits but has a significant cost, the age old question comes to mind – Is it worth it? Physicians want to think that they maximize the benefit while disregarding the cost, more often than not; they usually take into account the perceived benefits in regard to cost.

### d) **Environmental health and the prevention of diseases.**

Studies have shown that preventive medicine is the most cost effective method amongst hospitals.

Productivity and quality waste suggest possible methods of cost saving while still maintaining a high standard of quality. Some scholars have confidence that an increase of 20-40% of the overall healthcare outlays can be achieved.

### e) **The use of new technology**

Increases costs, nevertheless, it also improves the desired medical results. Just like in most industries a higher quality product demands a higher, yet warranted cost.

## 3. *The cost control system in relation to quality.*

The CQI principles are used with the purpose of achieving the highest standard of quality possible at the lowest potential cost. The goal of this system is to alter the procedure while making sure that failures in quality don't occur, as opposed to repairing them after they have already happened.

The two essential principles of the system are;

a) Achieving a high standard of quality in relation to cost, and

b) The elimination of unsuitable variants while monitoring improvement.

For a system of this nature to properly function, it requires the quality objectives of the final as well as the intermediate outputs of both processes be defined clearly defined in a quantifiable formula so as that all the outputs can be assessed against the specified terms.

## 4. *Patient/Customer values and medical ethics*

The constant progression of quality management in healthcare systems is done so with the use of excellent programs, serving as building blocks in the assurance of quality.

The CQI concept allows for the extension of the general notions such as terms and conditions, which have been previously regarded as the norm. Implementing such a philosophy allows for these methods of quality assurance to overcome complications with viable solutions, ultimately resulting in a mutual satisfaction for both patient / customer and provider as well as an overall improvement of the standard of quality offered.

#### 5. *Standards of quality for health care services.*

The main customers of health care services are indeed patients. As a result, it is crucial to measure their standards, in regards to healthcare services and make every effort in order to achieve those expectations every single time. If certain expectations are unreasonable or downright impossible, the key lies in educating the general population or consumers, so that, in the future patient expectations become achievable.

#### 6. *Cost of Healthcare:* There are three key aspects to consider:

*Firstly*, the quality of healthcare services offered is directly proportional to the capabilities and professionalism of the medical personnel as well as the managerial abilities of hospital administrators.

*Secondly*, there is the fear of misdiagnosis of patients leading to unnecessary treatment and hospitalization. Studies have shown that in some misdiagnosed cases, a significant amount of medical procedures and especially interventions are inappropriate. This leads to wasting of resources, but more importantly can also harm these patients in the process, therefore this aspect is of particular importance to healthcare investors.

*Thirdly*, is the way in which patients/customers are treated. Here is where resource utilization comes into play, in order to accomplish similar results for specific procedures and diagnoses. A perfect example of wasting productivity is the maintaining of incorrect variations of services even when the same results are obtained every time.

### **3. Methods for quality improvement and resource management**

There are certain measures one could apply in order to improve quality of health management (Cianfrani and West, 2009; Ellis and Whittington, 1993):

Preparation is very important, it is essential in obtaining optimum results. Once you are prepared, the next step is implementing the desired method. Lastly, and perhaps the most important is being innovative and coming up with the next revolutionary procedure in healthcare management. In order for this system to function properly there needs to be continuous observation and documentation of functional and non-functional implementations, such as, cost control and the elimination of incorrect variations of healthcare delivery.

The key to an effective system relies the importance of understanding the true essence of quality, and being able to apply it in areas that need fixing. This procedure embraces the interaction between customer and provider, through communication and the understanding of customer's needs, the overall satisfaction and moreover efficiency of healthcare delivery will inevitably increase.

To improve quality in hospitals as well as strengthen relationships between the cost of procedures and the quality of services offered, the following actions should be highly considered; First, and foremost is finding a process that works for you, if this means using a method applied by someone else in your field, or taking ideas from multiple methods, that is all fine, as long as it's efficient. There exist a number of distinct processes for clinical practice, whether it be diagnostic techniques or personalized medical procedures, they are the core of maintaining the quality of healthcare delivery (Campbell and ot, 2002).

Some methods cut diagnostic lines in half; the most common of examples are hospital admission, analyzing blood tests, and solicitation of payment. Finding the process which requires improvement is the only the beginning.

After choosing your intended method, then you must assemble a staff that is familiar with your system. Finding personnel

who are experienced and understand the process is essential for the increase in productivity. Each individual should be aware of the principles of quality management and cost control, or at least have some sort of notion in order for them to function efficiently as a team.

Last, but certainly not least, is meeting customer/patient expectations. Quality can be defined as meeting or exceeding the expectations of customers, this particular task relies highly on the conditions in which customers are being educated on the values of expectations and their ability to change over time. The most challenging task for the group is dealing with the different feedback offered from different expectations of customers. To maintain a balance in productivity they should first list the different outputs of the procedure, identify the customers, and measure their expectations of quality

Stressing the importance of doing these procedures strictly in writing is crucial. For far too long, many hospital administrators have viewed their own expectations to be the same as their customers. This mindset can ultimately lead to a degradation of the system, in the sense that, it may seem as if everything is efficient in the eyes of the manager, when in actuality customers' expectations are not being met consistently. The easiest method to avoid this downward spiral is the appropriate listing of customer feedback and being able to quantify expectations.

Administrative members should meet bi-yearly or at least once a year in order discuss productivity, functionality of procedures, customer satisfaction, and update the list accordingly. This includes implementing new procedures in areas that lack results, maintaining standards, and replacing unsuccessful variations with new more efficient ones. This process is necessary in order to assure quality, because as customers gain knowledge, the process begins to evolve, thus altering customer expectations (Benneyan and ot, 2003; Nederpelt, 2012).

In the field of medicine, the patient is the entire medical profession. Clinical procedures of diagnoses can be regarded as the measurement of expectation, which can be obtained by simple writing these procedures down and formulating a

hypothesis which should be investigated further. Due to the fact that these expectations are generated by the medical profession as a whole, not by particular physicians or healthcare institutions, a profession wide scale would be the best way to document these procedures.

#### 4. Recording the process

A **process** is an assortment of organized tasks originated as a reaction to a specific event which results in a particular outcome for the customer of that process. These processes usually involve a hierarchy, consisting of the three main categories of inputs, outputs and processes being broken down further into subcategories. Each of these processes can be broken down even further into sub-subcategories, and so on and so forth. There is an unbelievable amount of detail which goes into the construction and understanding such an intricate procedure.

The features of this process can sometimes be connected to the outputs but do not necessarily result in their outcome. Some outputs can be viewed as "laid back", due to the fact that, whether they are present or absent it does not affect the result of the process. There are strategic elements to a process; these elements can determine the expectations of quality set by the output. It is important to note the elements which produce the desired effect.

Applicable facts result from acquiring the necessary knowledge in order to understand the essential methods required for a process to function correctly. This knowledge can be obtained by performing these procedures on a day to day basis. By performing these tasks daily for an extended period of time, one grows accustomed to the procedure and begins to build a routine. Over time, ideas on how to improve this daily routine start to develop and be put into practice. In this particular instance, and in general, a process will not be able to manage without basic applicable knowledge.

Output generation and the stipulations of processes, are unequivocal, quantifiable statements in regards to the importance of the output's attributes.

In the lists which were asked to be drawn up by the team, there can be a sub-group of stipulations, resulting from the output of

customers and their expectations, and the necessary steps which lead to this process. These so called stipulations are what define the quantifiable variables, at the same offering no guarantees as to what levels of achievement they will result in.

There are two main levels at which these stipulations can be generated; on an external level, which results from customer expectations, and on an internal one, generated by the expectations of the process. These levels reflect two distinct features; the objective of the process as well as the manner in which it strives to achieve that intended target. Once again, documentation is crucial to allow for appropriate measurement of customer expectations, in addition to improvement of the process leading to alterations in customer expectations over time.

As in any process, stipulations are an integral component of that system. For these specifications to work they need to be recorded and quantified, in order to properly measure the consistent achievement of their objective. A large amount of resources are consumed by healthcare organizations in an effort to produce suitable conditions as well as develop applicable systems of quantified data management. Well-defined stipulations provide a foundation for the integration of a goal orientated system of measurement, furthermore providing the necessary opportunities for constructive criticism on improving the quality of healthcare delivery.

The importance of recording the process is often stressed because it facilitates the alteration of unproductive processes with new ideas for more functional ones. As these processes begin to be better understood, the next intention is to tailor them to customer expectations.

Constant improvement of quality is a process based on improvement of quality resulting from customer outputs and expectations. To gain a better understanding of the principles put in place by the process, but also the stipulations which are applied in their management, one must refrain from being subjective and focus strictly on gathering data from an objective perspective.

This particular concept focuses on customers' expectations and hitting that desired target every single time. Although this task is far from easy, due to the actions

of different hospitals taking place on different levels. For example, the quality of medical content and their results should be evaluated based on the expectations of the entire medical profession, resulting in the eradication of unsuitable variations in the results of medical procedures. Results of system functionality can be easily shared with other organizations as well as physicians in order to achieve an optimal process which can be applied universally.

Some hospitals/clinics have their processes taking place on a smaller scale, focusing more on satisfying local customers, rather than concentrating their efforts on improving the entire healthcare system (Freed, 2005). Hospitals can forge partnerships with other hospitals/clinics in an attempt to apply similar management systems. If their systems are functional, the collected data can be used as a marketing tool, for instance, hospitals can use patient surveys to advertise their rates of satisfaction in comparison to other hospitals, which will hopefully result in the influx of more patients. This process can also lead to greater efforts by hospital administrators to implement procedures of constant improvement of quality, under continuous documentation in the hopes of discovering a more functional method which they can then share on with other healthcare personnel

There are a few simple tasks any administrator can perform in order to improve the standard of quality offered. The most important of the lot are creativity and commitment. Having a vision for the intended path of your institution is the key in assuring a high level of quality. Conveying this method to your staff, but more importantly gaining the board's acceptance is essential in developing the next functional step.

Perhaps on the same level of importance as creativity and commitment is knowledge. Having experience in the field and understanding business strategies leads to better organization through the implementation of acquired managerial techniques. After having established an intended pathway and put into place a desired system for quality management, the next important step is identifying your target customers, having knowledge of your offered products and documenting your processes to



ensure the terms and conditions are on point. Next, you must train your staff in order to successfully apply and document your method. Your employees must be taught the basic principles of quality and customer expectations, if done correctly, their knowledge will grow over time allowing them to adapt to certain situations, resulting in increased levels of productivity.

Motivation and leadership are the last two pieces of the puzzle. Forming an appropriate reward system, targeted towards sections or groups rather than individuals, because that is where most improvement should be observed, is crucial in generating incentive amongst your employees. A great leader, leads not supervises, they should be able to guide and teach their employees all the while removing the obstacles of quality and motivating staff to always perform to the best of their abilities.

## 5. Conclusions:

Constant improvement of quality is deeply embedded within the culture of any healthcare institution. In order for this method to be efficient, it calls for the understanding of same notions of quality by all the healthcare workers. Furthermore, to achieve a high standard of quality at a consistent level depends almost completely, on the chosen method of quality management applied by healthcare organizations. The administrative team is entrusted with the tasks of assembling and supervising these particular processes. The success of an organization in the constant improvement of quality, depends on the managerial abilities of the administrator.

There have been a number of studies conducted on the indications for treatment of a disease and the intended course of action taken after the treatment is prescribed. This particular variation can be closely related to low levels of productivity as well as unused quality, resulting from a lack of clinical experience by physicians and medical personnel, as well as inadequate data on the clinical treatment of patients on order to base their decisions on. It is imperative that healthcare personnel document and record improvement in all designated areas of healthcare delivery, the two areas which can be the most cost saving as well as offer the

biggest opportunity for improvement of quality are, eliminating inappropriate treatment and hospitalization of misdiagnosed cases, through education and experience.

## 6. References:

- [1] Rose, Kenneth H. *Project Quality Management: Why, What and How* (2005)
- [2] Cianfrani, Charles A.; West, John E. *Cracking the Case of ISO 9001:2008 for Service: A Simple Guide to Implementing Quality Management*. (2009)
- [3] Ellis, R. and Whittington, *Quality Assurance in Health Care: A Handbook*, (1993)
- [4] Campbell, S.M., Braspenning, J., Hutchinson, A. and Marshall, M. "Research methods used in developing and applying quality indicators in primary care", *Quality & Safety in Health Care*. (2002)
- [5] Benneyan, J.C., Lloyd, R.C. and Plsek, P.E. "Statistical process control as a tool for research and healthcare improvement", *Quality and Safety in Healthcare*. (2003).
- [6] Nederpelt, Peter van. *Object-oriented Quality and Risk Management (OQR)*. A practical and generic method to manage quality and risk. (2012).
- [7] Freed, D. H. "Hospital Turnarounds: Agents, Approaches, Alchemy." *Health Care Manager* 24 (2005).
- [8] *Quality Assurance Terms Glossary*, The Elsmar Cove Web Site ([http://elsmar.com/wiki/index.php/Quality\\_Assurance\\_Terms\\_Glossary/](http://elsmar.com/wiki/index.php/Quality_Assurance_Terms_Glossary/), accessed 18 November 2015).

# Strategic Alternatives Adopted by Travel Agencies to Develop Tourism Services

Roxana-Mihaela Ionitã

Christian University "Dimitrie Cantemir" of Bucharest

[ionita\\_roxana2000@yahoo.com](mailto:ionita_roxana2000@yahoo.com)

## Abstract

*Domestic and international tourism as a mass phenomenon is one of social events with the highest economic growth rate in the twentieth century.*

*In Romania, the scale of this phenomenon is not very high, standing out modest position in terms of number of tourist arrivals, estimated at 0.6% of the world total, and revenue and lower a weight of 0.1% in world total. Just this demonstrates the complexity and subjectivity of the tourism phenomenon, influenced by economic, political, social, cultural, educational. The low level of development of a country and living standards, reduce tourist flows, even if it is rich tourism heritage.*

**Key words:** tourism, travel agency, strategy, development

**J.E.L. classification.:** M29

## 1. Introduction

Travel agencies constitute "the main link institutional working in tourism"[2]. The key role of travel agencies is an intermediary between tourism providers and tourists. In literature there are opinions that assimilates travel agencies role of a company's business, covering organization, offering and selling of travel packages to consumers tourists [3].

In a competitive market economy you can not expect products and services to sell themselves. The adoption of coherent marketing strategy involves not only creating a good product and attractive pricing of goods making available to the consumers concerned. Even if a company has products of the highest quality, if the costumers does not know anything about them is they are unlikely to sell. It should be noted that,

today, the range of products offered on the market is becoming wider, and buyers are forced to choose. Do not forget that they also have different reactions and requirements before product prices or to report product-services. Therefore strategies should be adopted different solutions to satisfy all consumers both in terms of financial and time or comfort. Travel agencies constitute "the main link institutional working in tourism". The key role of travel agencies is an intermediary between tourism providers and tourists. In literature there are opinions that assimilates travel agencies role of a company's business, covering organization, offering and selling of travel packages to consumers tourists.[1]

## 2. Marketing strategies adopted in travel agencies

Tourism development strategy is the art to select and optimize the resources and means that any travel company can have in order to achieve one or more objectives for progress. Associated policy, whose complement is, it forms a "corporate strategy". Associated tactics that condition, it constitutes "business strategy". These strategies are particularly popular because development or growth is associated with success or growth of turnover, and therefore profit company. This connection is not always true, but the preference for these strategies is prevalent among American managers, as well as the Europeans. In an unstable environment, uncertain, and with strong dynamics to survive in any business there should be an increase of turnover.[7]

Thus, we can say that most strategies are geared towards the achievement of growth targets, which has several explanations:

- increasing company ensures vitality, stimulate initiatives and is a motivating

employees;

- increase allows the company to meet competitors' actions due to economies of scale and experience that they provide.

The main objectives of increasing tourism company are: increasing the number of tourists, thus increasing turnover, profit growth, market share and size tourism company.

Tour companies following growth strategies or proposed development may have the following characteristics:

- have, in the majority cases, a higher than average rate of profit activity;
- regularly can develop innovations that translate into new services, new technologies or innovations related to new ways of submission and the new segments of the market for existing services
- show a growth rate higher than that promoting services markets
- may tend to create demand for its services in place to adapt to market requirements.

The development strategy aimed at achieving superior results of previous ones (both qualitative and quantitative), through strengthening the competitive capacity of the travel agency. This strategy requires the promotion of important qualitative changes in all areas of activity of the travel agency. To increase customer satisfaction, mitigate the risk of losing customers to actual or potential and have strong competitiveness, variety, quality and diversity are means ensuring the competitiveness and efficiency by enriching its content and quality supply.

Thus, to obtain a good market where allowances and a high reputation, travel agencies can adopt a series of development strategies derived from the overall strategy for each of its department.

### **2.1. The strategy of making original tourist services**

Travel agencies can address a strategy of services unique, original, heavily promoted domestically and internationally, and that meets international standards, the aim is to attract a larger number of customers. This can be achieved by creating a leadership team well organized and competent, which might improve the services and come up with new ideas and performance, but also be based

on well-trained, refined and specialized, capable lead to a competitive development agency.

### **2.2. The strategy of increasing the quality of tourism services**

Adopting strategies to increase quality travel services within the agency is achieved by promoting and enhancing the quality of services, which should happen permanently. This strategy should include:

- providing quality services that can be perceived by customers, including requirements and needs, for example safety, staff courtesy, professionalism;
- involving all employees, service quality being achieved only if they are properly trained and motivated to create quality services;
- existence of quality in all the agency for services to be at the best level;
- approach and collaboration with partners of the highest quality;
- continuous improvement of the quality of tourism services in comparison with the competition and finding new solution;
- increase the range of services and offering a good quality/price through continuous modernization of interior equipment and buildings;
- in periods when sales are declining tourism packages generally fall and spring, it is necessary to provide some free services and incentives clients, by offering specific gifts.

### **2.3. Strategies for maintaining business customers**

Adoption and strategies for attracting and retaining business customers, is of major importance because business tourism is type of tourism that has seen strong development. Although travels carry out an activity remunerated, they are treated tourism as the organization and their operation involves the use of both tourist accommodation, food, recreation, and consumption of specific services provided by the organizers holidays. Business customers are very important for travel agency because it maintains a permanent activity, which is due to their work carried out throughout the year.

## 2.4. Partial strategies to eliminate weaknesses

The use of partial strategies aimed at poor areas of the travel agency are necessary and very useful for creating a positive image among consumers. Differentiation image of agency is needed because customers react differently to a particular image, even if competing offers are similar. An image of success is the result of an identity that agency and it should create, this is possible through the support of strong promotional campaigns, both locally and nationally.

Create your own identity is aiming to shape the image of the travel agency's customers, should suggest a unique message on the position and quality of services offered on the market. This message must be sent in a different way in order not to be confused with messages competitors. Create an image and a solid reputation requires hard work and creativity as is transmitted to the permanent by any means possible.

## 2.5. Service differentiation strategies

Develop strategies for positioning and differentiation of services is necessary because different customer needs, each being drawn to a specific offer. This strategy aims at providing unique services, if possible, to increase the volume of services provided. This is possible by providing the requested service quickly, courteously and professionally by the staff. It has chosen to differentiate better ways to be effective and meaningful, because not every difference is an element of differentiation. Modes of differentiation from competitors must be chosen carefully, implying some costs, but also called advantages for customers.

Differences that agencies will have to make, must meet the following requirements to be effective:

- correspond to benefits well appreciated by customers;
- be presented in a special way;
- to be superior to those used in the previous period;
- to be disclosed to the customer;
- be unique characteristic of the agency, to not let the opportunity to copy competitors;
- be available to offer customers the

possibility to consume them, to be profitable and effective for travel agency.

## 2.6. Strategies softening conflicts

Adopting strategies softening conflict in the agency goes through the preservation and fostering of qualified personnel, trained, generating ideas by changing some outdated mentalities, promoting a permanent communication based on mutual trust. It is also necessary to address strategies for differentiation. Differentiation strategy can be used continuously, it is that, the travel agency may obtain a strong competitive advantage by hiring and training staff with qualities superior to competitors personnel.

The criteria set by the strategy, which must meet the travel agency's employees are:

- competence (knowledge and skills necessary to have the position held)
- kindness (employees must be careful, respectful and friendly)
- credibility (to be trustworthy)
- safety (must fulfill their obligations promptly and consistently)
- sense of responsibility (to act and respond immediately to customer requests and problems)
- communicative (employees must understand its customers and to express their meaning).

## 2.7. Marketing Strategies

Travel agencies can promote a marketing strategy that is based on the forms of marketing communication. The aim is to make known the agency offer and give collaborate with a many travel agencies from the country and abroad. These strategies include:[4]

### • Strategies for market penetration

Develop strategies for market penetration are essential because they are based on existing market services and formulating a set of actions to increase the percentage of market share, which can be achieved through its production of tourist services to eliminate competition.

### • Promotion and communication strategy

The adoption of strong promotion and communication strategy, involving

development of a program to promote services that include [5]:

- identify customers on affecting them and their picture agency services;
  - defining and promoting communication objectives;
  - budgeting for these actions;
  - follow-up of action to see whether customers have been informed and whether the actions were effective.
- **Strategies to conquer a better position on the market**

Adopt a strategy aimed at holding a better position on the market implies the need for a clear long-term vision of the management of travel agencies, but also a renewal of its range of services and provision by increasing their quality.

### **3. Conclusion**

The main purpose of any travel agency is to make known the national and international tourism market as the best bidder of tourism products ensuring maximum satisfaction of its customers, and for travel agency optimal gains and long-term profits.

All the travel agency's activities will be consistent with its responsibilities for customers, employees and its preoccupations for the development and optimum use of material, financial and human resources.

### **4. References**

- [1] Cosmescu I. “Turismul – fenomen complex contemporan”, Editura Economică, București, 2007.
- [2] Dionisie C., “Managementul turismului. Structuri de concepție și organizare”, Editura Junimea, Iași, 2002.
- [3] Florescu C., “Marketing”, CoEd Marketer-Expert, București, 2006.
- [4] Gherasim T., Gherasim D, “Marketing turistic, Editura Economică”, București, 2005.
- [5] Olteanu V., Cetină I., “Marketingul serviciilor”, Editura Expert, București, 1994
- [6] [www.mdr.ro](http://www.mdr.ro)
- [7] [www.scritub.com](http://www.scritub.com)

# A Look at Managers' Perception of the Innovation Activity in the Hotel Industry in Romania

Maria-Cristina Iorgulescu  
Bucharest University of Economic Studies  
[cristina.iorgulescu@com.ase.ro](mailto:cristina.iorgulescu@com.ase.ro)

## Abstract

*The article presents the specific of the innovation activity in the hotel industry, by presenting the results of a qualitative research. Based on in-depth interviews with general managers of Romanian hotels, the study highlights managers' perception of the importance of innovation for this specific economic sector. Moreover, the research brings under attention specific examples regarding the innovation activity in Romanian hotels, the types of innovation implemented and the frequency of their implementation in the accommodation units. The results mainly confirm the conclusions of previous studies, highlighting that the hotel industry does not implement radical innovations, but rather incremental ones, aimed at improving hotel's activity.*

**Key words:** innovation, hotel, management  
**J.E.L. classification:** M10, O30, Z32

## 1. Introduction

The literature on innovation in the tourism industry and, particularly, in the hotel industry began to develop in a more serious manner after the year 2000, the research on this subject highlighting that the innovation activity in this sector has unique characteristics, different than the ones of the manufacturing sector [9].

As competition is intensifying (especially in the light of the globalization process), the rate of innovation has increased considerably in recent years [2], although the hotel industry has always proven to have the capacity to innovate by adapting to the challenges imposed by the market or by the constantly changing customer needs [6].

At organizational level, one of the widely

accepted definitions of innovation is the one imposed by OECD, that describes it as an element (be it product, process, marketing or organizational method) that is new (or significantly improved) to the firm [7]. Moreover, the classic typology of innovations highlights two categories (Schumpeter, 1934, cited by OECD and Eurostat, 2005): radical innovations (that lead to major changes) and incremental innovations (which contribute to continued growth through change) [7].

One of the academics who have thoroughly studied the innovation activity in the tourism industry is Anne-Mette Hjalager. As a result, the author considers suitable to present her approach in classifying innovations in the hotel industry [3]:

- product or service innovations: changes that can be noticed and perceived as new elements (within the organization or market) by the consumer, with impact on the purchase decision;
- process innovations: changes in the back-office activity, aimed at increasing productivity and efficiency; process innovations are, in most of the cases, based on technological investments (especially in the field of information and communication technologies); although process innovations may not be perceived directly by the customer, they reflect in an improvement of services, with a positive impact on products' value;
- managerial innovations: new ways of internal organization, of tasks distribution and empowerment of employees, career management, remuneration management systems and reward performance (Ottenbacher and Gnoth, 2005, cited by Hjalager, 2010); these innovations are not perceptible to consumers, but can be applied to mitigate staff turnover, increase job satisfaction for hotel's employees, all

these aspects having a direct impact on the quality of services provided and, hence, on customer satisfaction;

- marketing innovations: new approaches in marketing communication, new methods of managing the relationship with the customers (Hankington, 2044, cited by Hjalager, 2010);
- organizational innovations: new collaborative structures (alliances) or a new legislative framework designed to support the business environment in the hotel industry.

Currently, academics highlight that the tourism industry is characterized by superficial changes in product offerings [11], the diffusion of innovations in the hotel industry being fairly low especially in the case of product and process innovations, as this sector mostly implements incremental innovations based on existing resources in the organization [1]. Moreover, it should be noted that the innovation process in the hotel industry is directly determined by its suppliers' performance, as the innovation activity is "supplier-driven" [8], the majority of innovation sources (especially in the case of technological innovations) being found outside of the tourism sector [2].

These being considered, the author intends to create an overview of the innovation activity in the Romanian hotel industry, as this subject is little investigated.

## 2. Research methodology

In order to identify managers' perception of the innovation activity in the Romanian hotel industry, it was decided to conduct a qualitative research based on an in-depth interview. The study was not intended to have statistical representativeness; as a result, the target group of this qualitative research was formed of general managers of hotels in Bucharest.

The author decided to conduct a total research in Skål International Bucharest, the Romanian branch of Skål International - International Association of Travel and Tourism Professionals Founded in 1934, the only international organization reuniting all the sectors of the tourism industry [12]. Skål International Bucharest is a professional association formed by 74 managers in all the sectors of the tourism industry, the author

being a member of the youth division.

The interviews were conducted using a semi-structured interview guide designed in order to facilitate a better understanding of: managers' perception on the importance of innovation in the hotel industry, the innovation activity in hotels, the types of innovation implemented in hotels, the frequency of innovation's implementation. In addition, it has to be mentioned that all the interviewed managers received conceptual clarifications regarding the issues to be discussed (the definition of innovation and its typology in the hotel industry, using Hjalager – 2010 point of view). Although all hotel managers (members of Skål International Bucharest) were invited to take part in the study, from the 26 persons contacted, only six accepted to be interviewed (three female and three male). Five of the respondents manage 4-star hotels, only one managing a 3-star accommodation unit. Moreover, four of the interviewed managers have in charge the activity of an independent hotel, while only two members of the target group manage the operations of an accommodation unit affiliated to an international hotel chain. This being considered, the author acknowledges that the research has its limitations.

## 3. Results and discussion

The interviews were centralized in a Microsoft Word document used in order to conduct a content analysis.

First of all, the main objective of the research was to identify hoteliers' perception of the importance of innovation in their industry. All the interviewed managers stated that innovation is absolutely essential for gaining competitive advantage on the local market by helping to differentiate from the competitors and to adapt to the new trends imposed by the industry and customer needs. However, while the interviewed managers stated that innovation should be included in the management strategy of every accommodation unit, the majority of respondents highlighted that the hotel industry faces big differences between the innovative capacity of large hotel chains (with a higher power of investment) and independent hotels, that either "imitate the behavior of market leaders" or endeavor "to differentiate through innovation and

creativity" in delivering products and services. This result confirms the conclusions of previous studies [8, 9] that have revealed differences in the innovation performance of the hotels operated independently and those integrated into a voluntary chain.

Furthermore, the research was aimed to identify hoteliers' perception of the importance that consumers allocate to the innovation performance in the process of choosing the services of a specific accommodation unit. First of all, it was mentioned that the innovation process should be tailored to the customer segment the hotel is addressing, the interviewed managers stating that hotel innovations are most important for the leisure tourists and not very important for business tourists. Although it was found a consensus that innovations are important in attracting customers' attention ("the comfort of a good bed, a conference room and a palatable dinner are not enough anymore") by increasing hotel's attractiveness (especially by promoting new communication technologies or by adopting a responsible attitude towards the environment), part of the respondents truly wanted to emphasize that the innovation performance does not influence in a decisive manner customers' decision to choose the services of an accommodation unit ("innovation is not in the top 5 criteria for selecting a hotel"). This point of view is confirmed by the results of two surveys conducted among Romanian consumers of hotel services, which indicated that the novelty and innovation performance of a hotel are only somehow important [10], the innovation performance being ranked 7 in a top 10 factors that influence the purchasing decision of hotel services, as the most important factors were considered to be the quality-price ratio, the comfort level, location and good references from relatives or specialized sources [5].

Based on these considerations, it is not surprising that all the interviewed hoteliers stated that the accommodation units they manage do not have set annual targets aiming the implementation of innovations. However, the research registered a consensus on the fact that in order to meet organizational objectives (regarding the compliance with the revenue and expenditure budget, profit levels, customer satisfaction and rate of loyal

customers), hotels need creative employees, although the level of creativity and innovation orientation is not a formal criterion for assessing personnel performance. Furthermore, the interviewees representing a hotel affiliated to an international brand mentioned that although their organizations have not set objectives regarding the innovation activity, such targets are set by the international hotel chain they are a part of. Furthermore, the qualitative research aimed to identify the types of innovation implemented by Romanian hotels. As expected (in the light of the conclusions elaborated by Camisón and Monfort-Mir, 2012 – [1] in their study), all the interviewed hoteliers acknowledged that the accommodation units under their management have not implemented radical innovations, but have implemented a number of incremental innovations. Most of the examples given regarding this aspect aimed adapting to new market requirements imposed by the development of technology and communication channels (increasing the budget for the Social Media activity, implementing a Search Engine Optimization designed to increase the site's visibility in the results provided by the Search engines and increase the traffic to the hotel's website), changing or improving reservations platforms and engines, introducing new sales programs, creating solutions for reducing costs arising from the accommodation or food and beverage activity, based on the information obtained from the history data provided by the property management systems, improving customer's experience in the hotel or restaurant (by changing the setting and hotel's design).

In addition, following the classical typology of hotel innovations (product/service innovation, process, marketing, managerial or organizational innovation), the research aimed to identify hotel managers' perception on the most important categories of innovation for this particular business sector. Most of the interviewees highlighted that a process of grading the types of innovation is impossible, arguing that all the categories are important, their ranking constantly being influenced by hotel's needs and customers' requirements. However, some respondents admitted that, based on their managerial experience and



interaction with customers, a greater attention is given to product/service innovations (due to their visibility) and marketing innovations, organizational or process innovations being less pursued. Thus, these results confirm the findings of another pilot study conducted among Romanian hotel general managers [4], according to which hoteliers appreciate most product and marketing innovations, while process innovations are least appreciated.

When discussing the most frequent implemented types of innovations, the opinions were diverse. A part of the interviewed managers stated that the hotels they coordinate most often implement marketing innovations, while the other managers mentioned that their hotels implement service innovations (due to the relatively low costs involved) and process innovations (mainly aiming to gain a more efficient activity and cost reduction). However, there was a consensus on the fact that hotels rarely implement organizational innovations.

Thus, the research intended to identify a series of specific examples of innovations implemented by hotels in Romania. The interviewees brought under attention various examples, although some acknowledged that the hotel under their management had not introduced all types of innovation under discussion (in example, managerial and marketing innovations). When discussing product and service innovations, it was mentioned: the change of the room type and design, the introduction of specific products and services for different categories of customers (in example, for the segment of customers with extended stay, the hotel can provide a "kitchen kit", as a part of the hotel's suits have a private kitchen; for the M.I.C.E segment there have been designed special coffee breaks) as well as introducing the possibility of checking in using online platforms. Marketing innovations implemented by Romanian hotels were aimed at adopting new methods of promotion (by being present at different events), to the detriment of traditional methods (advertising in newspapers and magazines) and adapting to the latest mobile communication technologies (by transferring the promotion activity to mobile platforms). Moreover, the managers interviewed mentioned that the hotels under their coordination had

implemented marketing innovations by changing the distribution channels (in example, by adherence to global distribution systems) and by designing new customer loyalty programs. There were mentioned few management innovations, these principally being related to new methods of increasing employees' loyalty (by involving them in CSR programs or by changing the procedures used for internal promotion) and to changes in the organizational structure (reorganization of the departments). As naturally expected, no organizational innovation was mentioned.

#### **4. Conclusions**

The qualitative research highlighted that Romanian hotels do not have a formal, well-grounded policy regarding innovation, the organizations of this specific activity sector mainly aiming the implementation of incremental innovations designed in order to improve hotel's activity, streamline processes, adapt to new technologies and customers' needs. Moreover, it was noted that there is no standard frequency of implementing innovations, as the hotels do not have goals set in this regard.

Obviously, given the nature of the research and the dimension of the target group, the results presented in this article do not outline a pattern of innovation practices in the Romanian hotels, but rather clarify the manner in which the innovation activity is perceived by hotel managers, outlining an overview on this little investigated issue. Thus, it was noted that hotels mainly aim implementing marketing, product or service innovations, as the organizational innovations are more appreciated and, therefore, neither implemented. The results of this study can form a strong starting point for a quantitative, more comprehensive research on the innovation activity in the hotel industry in Romania.

#### **5. Acknowledgement**

The study presented in this paper is part of the PhD research, that was co-financed from the European Social Fund through Sectorial Operational Programme Human Resources Development 2007-2013, project number POSDRU/159/1.5/S/134197 „Performance and excellence in doctoral and postdoctoral

research in Romanian economics science domain".

## 6. References

- [1] Camisón, C., Monfort-Mir, V. M., "Measuring innovation in tourism from the Schumpeterian and the dynamic-capabilities perspectives", *Tourism Management*, 33, 2012, pp. 776-789.
- [2] Hall, C. M., Williams, A. M., *Tourism and Innovation*, Routledge - Taylor & Francis Group, New York, 2008.
- [3] Hjalager, A.M., „A review of innovation research in tourism”, *Tourism Management*, Volume 31, Issue 1 (February), 2010, pp. 1-12.
- [4] Iorgulescu, M.-C., Răvar, A. S., "Measuring Managers' Perception of Innovation in the Romanian Hospitality Industry", *Procedia Economics and Finance*, 6, 2013a, pp. 512-522.
- [5] Iorgulescu, M.-C., Răvar, A. S., "Tourists' satisfaction with innovation in Romanian hotels", *Proceedings of the 7th International Management Conference „New Management for the New Economy”*, 7-8/11/2013, Bucharest, Romania, 2013b, pp. 694-703.
- [6] Marée, G., "Innovation Management in the Hospitality Industry: New Roads Towards Meaning and Corporate Culture", chapter (pp. 125-132) in *Trends and Issues in Global Tourism 2011*, editors: Roland Conrady și Martin Buck, Springer, Berlin, 2011.
- [7] OECD (Organization for Economic Co-operation and Development), Eurostat (Statistical Office of the European Communities), *Oslo Manual: Guidelines for collecting and interpreting innovation data, 3rd edition*, OECD Publishing, Paris, 2005, available at: [http://www.keepeek.com/Digital-Asset-Management/oeed/science-and-technology/oslo-manual\\_9789264013100-en#page1](http://www.keepeek.com/Digital-Asset-Management/oeed/science-and-technology/oslo-manual_9789264013100-en#page1), accessed 07.11.2015.
- [8] Orfila-Sintes, F., Crespí-Cladera, R., Martínez-Ros, E., "Innovation activity in the hotel industry: Evidence from Balearic Islands", *Tourism Management*, 26 (6), 2005, pp. 851-865.
- [9] Shaw, G., Williams, A. M., Bailey, A., *Innovation Processes In the Hotel Industry*, Advanced Institute of Management Research, London, 2012, available at [http://www.aimresearch.org/uploads/file/Publications/Executive%20Briefings%202/AIM\\_Hotel\\_EB\\_FINAL.pdf](http://www.aimresearch.org/uploads/file/Publications/Executive%20Briefings%202/AIM_Hotel_EB_FINAL.pdf), accessed 28.10.2015.
- [10] Țigu, G., Iorgulescu, M.-C., Răvar, A. S., „The impact of creativity and innovation in the hospitality industry on customers”, *Journal of Tourism Challenges&Trends*, Volume VI, No. 1, June, 2013, pp. 9-34.
- [11] Weiermair, K., „Product improvement or innovation: what is the key to success in tourism?”, *OECD Tourism Committee: Conference on Innovation and Growth in Tourism, Lugano*, 18-19 September 2003, 2004, available at <http://www.oecd.org/cfe/tourism/34267947.pdf>, accessed 02.11.2015.
- [12] <http://www.skal.org/>, accessed 02.11.2015

# The Quality of Hotel Services in Romania: an Application of the Servqual Model

Maria-Cristina Iorgulescu  
Bucharest University of Economic Studies  
[crisrina.iorgulescu@com.ase.ro](mailto:crisrina.iorgulescu@com.ase.ro)

## Abstract

*The role and importance of service quality for hotel businesses cannot be contested. It is extremely important for managers to understand customers' expectations. As a result, the paper presents an application of the Servqual model on the hotel industry in Romania. By using the Servqual scale, the article highlights the service dimensions Romanian consumers appreciate most in the hotel industry. The results show whether consumers are satisfied with the quality of Romanian hotel services. The implications of these results are discussed.*

**Key words:** Servqual, service quality, hotel industry, customer satisfaction

**J.E.L. classification:** M10, Z33

## 1. Introduction

In the present business environment, practitioners in the hospitality industry face difficulties in deciding how to best allocate their resources in order to improve or maintain service quality at a proper level. Although the literature on customer satisfaction is diverse, the subject continues to attract both scholars' and practitioners' attention. The paper begins with a short literature review on the methods of measuring service quality in the hospitality industry, followed by a discussion of the research methodology and the results of the exploratory study conducted by the author. The article concludes with a discussion of the Servqual score identified for the hotel industry in Romania and its implications.

## 2. The quality of hotel services

Academics acknowledge that managing and measuring the quality of hotel services is an extremely difficult initiative due to the intangibility of services [6, 8] or other characteristics of the hotel industry, such as fluctuating demand [1]. There are two perspectives of assessing service quality [6]: an "objective" perspective (based on specific standards that can be measured by verifying the availability of certain facilities in the accommodation unit) and a "subjective" perspective (based on the perception of customers and experts). The need to measure service quality is growing, as hotel managers are obliged by the business environment to continuously meet customer requirements and expectations in order to achieve competitive advantage [3]. Furthermore, it should be noted that service quality directly and positively influences customer satisfaction, which also influences customer loyalty [3]. As a result, the present article will discuss hotel service quality based on a "subjective" perspective.

Traditionally, customer satisfaction in the hotel industry has been studied by highlighting customer perception of service quality [7]. This approach is contested by some researchers (in example, Ren et al., 2016), as they highlight that while service quality is assessed using a cognitive evaluation of the characteristics and dimensions of the hotel service, customer satisfaction is also influenced by the emotional component of the service consumption [7]. Moreover, some studies indicate that the "gap" between the consumers' perception of hotel service and the actual experience of hotel service is determined by poor quality information, as customers are not provided with "reliable and meaningful" information at the point of purchase: as a result, prior to the service

encounter, customers tend to form unrealistic expectations about the forthcoming experience [2].

Researchers have tried to develop several instruments for measuring or improving service quality in the hotel industry [8]:

- the Servqual scale (designed by Parasuraman, Zeithaml and Berry, 1988) aimed at evaluating five service dimensions: tangibles, reliability, responsiveness, assurance and empathy;
- quality audits: aimed at identifying the determinants of errors in delivering the service, the frequency at which these errors occur, the associated costs for each type of error and the possible solutions;
- Total Quality Management: a set of managerial practices and philosophies aimed at enhancing quality in the organization.

The Servqual model is a widely recognized instrument in researching service quality, and its utility for the hotel industry has already been proven [3]. In addition, some researchers went even further and, based on the Servqual service dimensions, created new instruments specifically designed to assess service quality in the hotel industry [1, 3, 7]: Lodgserv (designed by Kuntson et al., 1990), Holserv (designed by Mei et al., 1999) and Lodging quality index – LQI (designed by Getty and Gettly, 2003). However, these new research instruments did not manage to gain as much popularity as Servqual [7]. Although very popular, the Servqual model, by imposing specific dimensions of service quality, has been criticized over time. One reason would be the fact that consumers mainly perceive service quality as a holistic experience and not as a series of dimensions [9]. These being considered, the author will proceed to present an application of the Servqual model on the Romanian hotel industry.

### 3. Research methodology

Conducting a research aimed to determine consumers' satisfaction with a particular service is a rather difficult initiative, mainly hampered by the highly complex and variable nature of services, as a service is rarely perceived in the same manner by two different consumers [11]. Moreover,

conducting such a research among hotel customers is even more challenging, given the complexity and heterogeneity of this sector. However, considering these inconveniences, the author considered useful to conduct a research in order to determine customers' satisfaction with Romanian hotel services.

The primary data collection was conducted using a direct research method (a structured, undisguised, personal survey), the data collection tool being a questionnaire. As the research was exploratory, the author chose a non-probabilistic sampling method, aiming to conduct a targeted sampling in order to include in the research only those consumers who can provide relevant information on the studied subject. As a result, it was deemed appropriate to conduct the survey among the visitors of the Romanian Tourism Fair, organized by Romexpo with the help of some well-known partners in the tourism industry. The study was conducted during the fall 2014 edition (November 13 to 16) and spring 2015 edition (12 to 15 March), mainly with the help of two groups of second year students of the Faculty of Business and Tourism (Bucharest University of Economic Studies). A total of 282 consumers of Romanian hotel services were interviewed, the sample being considered satisfactory, although it is not statistically representative at national level.

The research instrument used to conduct the survey was a standardized questionnaire – the Servqual scale [10, 11], whose usefulness in studying consumers' satisfaction with services has already been tested and validated. The model implies two main sections [10, 11]:

- a first section, comprising 22 statements designed to reveal consumers' expectations regarding a particular service (in this case, hotel services);
- a second section, comprising a similar set of 22 statements meant to indicate consumers' perception regarding the services actually offered by the business environment (in this case, the Romanian hotel industry).

The 22 items take into consideration five main dimensions of service quality determined by Zeithaml et al. (1990) as a result of several qualitative studies (hundreds of interviews conducted among consumers in

several services sectors) [10]:

- tangibles: the layout of physical facilities and equipment, staff's appearance and communication tools;
- reliability: the ability to deliver the promised service in a groomed manner that inspires security;
- responsiveness: the willingness to help customers and deliver services in a timely manner;
- assurance: good training and friendliness of the staff, as well as its ability to convey trust and a sense of security to the customers;
- empathy: personalized care and attention that the organization manages to offer to its clients.

For all the 44 items it was used the semantic differential scale (1 – “strongly disagree”; 7 – “totally agree”) indicated by Servqual creators [10, 11]. Moreover, the Servqual model comprises a third section aimed to indicate the relative importance consumers give the five service quality dimensions, this part being included in the questionnaire between the two main sections aforementioned.

The author chose to use the Servqual scale as it helps to highlight the dimensions on which organizations should focus its efforts in order to improve the quality of the services offered, as well as to reveal specific issues on which consumers are dissatisfied.

In addition, the questionnaire was designed with an introductory – “filter” question (to ensure a proper selection of respondents, aiming to include in the study only those consumers who have been accommodated in a Romanian hotel in the past 12 months) and three other opening questions meant to broadly outline hotel consumers' behavior: the frequency and purpose of travel, type of accommodation unit preferred and preferred comfort level. Furthermore, the questionnaire ended with five classification questions designed to reflect the demographic profile of the respondents, depending on age, sex, education level, employment status and income level. The result of the survey are presented and analyzed in the following section of the paper.

#### **4. Results and discussion**

All completed questionnaires obtained in the research were registered into a Microsoft Excel file and the results were interpreted using the IBM SPSS Statistics software. All the respondents who took part in the survey are Romanians, this being a limitation of the study. The author acknowledges that it would have been also interesting to research foreign tourists' opinion regarding the quality of hotel services.

The distribution of respondents based on gender is balanced, as 52.77% the interviewed customers were male, the other 47.23% being female. Most of the persons who participated in the study are very young (28.09% are under 24 years old), the distribution on other age groups being somewhat homogeneous, as 21.7% of the respondents are between 25 and 34 years old, while 16.17% are between 35 and 44 years old and 34.04% are over 45 years old. Moreover, almost three quarters of the respondents (72.35%) have higher education. Also, more than half (54.05%) of the respondents are employed, while nearly fifth of them (19.57%) are entrepreneurs or have a managerial position in a company. Given the distribution of respondents by age groups, it is not surprising that 19.15% of the surveyed customers are students, only 7.23% of the ones interviewed being inactive on the labor market.

The distribution of respondents according to their average monthly income is presented rather heterogeneous, indicating that most respondents have a modest income, considering that only a quarter (25.53%) manage to gain over 2,500 lei per month and 36.59% gain between 1,500 and 2,500 lei per month. Furthermore, the fact that almost a quarter (23.84%) of the surveyed customers have an average monthly income below 1,000 lei is not surprising, given that 19.15% of the respondents are still students and do not have a job.

Besides outlining respondents' demographic profile, the classification questions used in the research instrument also focused on highlighting the purchase habits of the respondents, by indicating the frequency and purpose of their travel, the type and comfort level they prefer in a hotel. As a consequence, it should be mentioned that most respondents (51.49%) use the

services of a Romanian hotel two-three times per year, while almost third (32.34%) stay in an accommodation unit of this category once a year. The percentage of those who purchase hotel services more often is rather low, as only 8.51% of respondents travel in Romania on a monthly basis and 7.66% spend their nights in a Romanian hotel at least twice a month.

Furthermore, most respondents (67.66%) choose the services of a hotel in Romania as a result of journeys undertaken for personal reasons, while only 8.09% travel exclusively for professional interests. The other surveyed customers have been accommodated in Romanian hotels largely during their personal voyages (but also when traveling for business reasons – in 14.04% of the cases), the rest of the respondents (10.21%) choosing to stay in a hotel mainly during business trips.

The distribution of respondents based on their reasons for traveling is somewhat natural, considering the fact that the survey was conducted among the visitors of the Romanian Tourism Fair, an event dedicated mainly to those who want to purchase holiday packages. Consequently, it would have been interesting to survey more persons who travel exclusively for professional interest, as business tourism causes 40% of Romanian and foreign arrivals in Romanian hotels [5].

It should be further mentioned that most consumers (56.17%) who participated in the survey prefer lodging in independent hotels, as only 43.83% of the respondents use to stay in a hotel affiliated to a chain, which offers standardized services. The higher demand for independent hotels is probably determined by the fact that Romania has few accommodation units integrated in a hotel chain, as the hotels affiliated to an international chain represent only 7% of the Romanian hotel market, most of these units being located in Bucharest [4].

In terms of comfort level preferences, the majority of the respondents (50.21%) prefer to stay in 3-star hotels, while less than one third of the surveyed consumers (31.49%) opt for the services of a 4-star hotel. Also, only 10.21% of the respondents prefer the accommodation units classified at 2-stars, while 7.23% choose to stay in upper class (5-star) hotels. These being mentioned, the

author intended to verify whether the option for a certain type of hotel is influenced by the traveling reasons. The  $\chi^2$  test (with a value of 0.61, while the critical value of  $\chi^2$  is 3.84, considering one degree of freedom and a 0.05 significance level) highlights that there are no significant differences between the options of business or leisure tourists in terms of the type of hotel preferred (an independent unit or a hotel part of a standardized chain). Similar results were obtained when there were considered the preferences for hotel's comfort level, as the  $\chi^2$  test (with a value of 1.48, considering a value of 7.81 for critical  $\chi^2$  – for 3 degrees of freedom and a 0.05 significance level) indicated, once again, that there are no differences between the options of business and leisure tourists.

Once established the profile of the respondents (tourists traveling, mostly, on personal reasons, who prefer three or four-star independent hotels), the analysis of the results will continue by presenting the most important findings. First of all, as previously mentioned in the research methodology section, the questionnaire (using the Servqual scale) was designed in order to identify the relative importance consumers attach to the five quality dimensions. In this regard, the respondents were asked to distribute 100 points along the five quality dimensions of hotel services according to how important they perceived each dimension to be.

The results indicate that, in evaluating hotels and the services offered by these, consumers value the most the tangibles ("the layout of physical facilities and equipment, staff's appearance and communication tools" have an impact of 26.71% on the quality of the hotel service) and the reliability dimension ("the ability to deliver the promised service in a groomed manner that inspires security" has an impact of 23.04% on the quality of the hotel service), the least appreciated dimension being empathy ("personalized care and attention that the organization manages to offer to its clients" have an impact of 15.25% on the quality of the hotel service). This last aspect revealed by the survey is somewhat surprising, indicating that the respondents probably have an overly pragmatic view of hotel services by not looking for a great, personalized experience, but rather for receiving certain basic services (accommodation and meals)

that should be of good quality and delivered at the right moment.

Furthermore, the author will present the Servqual score identified for each of the five service quality dimensions, after applying the specific methodology indicated by Servqual creators [10]. In brief, the score is obtained by using the formula:

$$\text{Servqual score} = \text{perception score} - \text{expectation score}.$$

This formula will also be applied in order to obtain the weighted Servqual score, calculated by using the relative importance consumers give to each of the five quality dimensions. By applying the correct methodology, both versions of the Servqual score were computed, the results being presented in table 1, noting that "E.s." represents the "expected score", "P.s." represents the "perceived score" and "Servqual" represents the Servqual score.

*Table 1. The Servqual score for Romanian hotels*

Quality dimension	E.s.	P.s.	Servqual
Tangibles	5,85	4,81	-1,04
Reliability	5,99	4,78	-1,21
Responsiveness	5,92	4,62	-1,3
Assurance	6,08	4,72	-1,36
Empathy	5,75	4,58	-1,17
Quality dimension	E.s.	P.s.	Weighted Servqual
Tangibles	1,57	1,29	-0,28
Reliability	1,38	1,1	-0,28
Responsiveness	1,09	0,84	-0,25
Assurance	1,01	0,78	-0,23
Empathy	0,88	0,7	-0,18

Source: research results

In the case of each dimension, it can be easily noted that the Servqual score has a negative value, which indicates that Romanian hotels offer services with a lower quality than customers actually expect. Computing both versions of the Servqual score proved to be useful, considering the fact that according to the classic version (unweighted score) one may say that respondents have the higher standards for the "assurance" dimension (expected score: 6.08), while the weighted version of the score reveals that respondents have the higher

expectations in terms of the quality of the tangible elements of hotel services (expected score: 1.57). In both cases, though, it should be noted that respondents have the lowest expectations regarding the quality of the "empathy dimension" of hotel services.

Considering the Servqual weighted score, it should be further mentioned that respondents are most satisfied with the quality of tangibles and the reliability dimension of Romanian hotel services. Furthermore, as all Servqual scores are negative, the study highlights that consumers are not satisfied with the quality of services provided by Romanian hotels.

## 5. Conclusions

The paper presented a research highlighting the views of Romanian consumers of hotel services who use to travel mainly for personal reasons, who are highly educated (as 72.35% of the persons who participated at the study have a university degree) and who prefer lodging in 3-4 star hotels. The study brought under attention in this article highlights that Romanian hotels fail to provide services with a quality as expected by consumers. However, it should be noted that the study has its limitations, as it is exploratory in nature and its results are not representative of the whole population. Moreover, the application of the Servqual scale for all the respondents involves certain limitations: for example, consumers who use to accommodate in upper-scale hotels (4-5 star units) perceive the quality of hotel services in a different way than those who usually stay in 2-3 star hotels. As a result, a more comprehensive research should be based on a better targeted sampling method. In addition, future studies should use a more comprehensive research instrument that will permit outlining an analysis on the relationship between service quality and customer satisfaction.

## 6. Acknowledgement

The study presented in this paper is part of the PhD research, that was co-financed from the European Social Fund through Sectorial Operational Programme Human Resources Development 2007-2013, project number POSDRU/159/1.5/S/134197 „Performance

and excellence in doctoral and postdoctoral research in Romanian economics science domain".

## 7. References

- [1] Akbaba, A., "Measuring service quality in the hotel industry: A study in a business hotel in Turkey", *Hospitality Management*, 25, 2006, pp. 170-192.
- [2] Briggs, S., Sutherland, J., Drummond, S., "Are hotels serving quality? An exploratory study of service quality in the Scottish hotel sector", *Tourism Management*, 28, 2008, pp. 1006-1019.
- [3] Deng, W.J., Yeh, M.L., Sung, M.L., "A customer satisfaction index model for international tourist hotels: Integrating consumption emotions into the American Customer Satisfaction Index", *International Journal of Hospitality Management*, 35, 2013, pp. 133-140.
- [4] Euromonitor International, *Passport: Travel accommodation in Romania*, October 2014, available at <http://portal.euromonitor.com/>, accessed at 09.11.2015.
- [5] Euromonitor International, *Passport: Travel and tourism in Romania*, October 2014, available at <http://portal.euromonitor.com/>, accessed at 08.11.2015.
- [6] Núñez-Serrano, J.A., Turrión, J., Velázquez, F. J., "Are stars a good indicator of hotel quality? Assymetric information and regulatory heterogeneity in Spain", *Tourism Management*, 42, 2014, pp. 77-87.
- [7] Ren, L., Qiu, H., Wang, P., Lin, P. M.C., "Exploring customer experience with budged hotels: Dimensionality and satisfaction", *International Journal of Hospitality Management*, 52, 2016, pp. 13-23.
- [8] Torres, E. N., Adler, H., Behnke, C., "Stars, diamonds, and other shiny things: The use of expert and consumer feedback in the hotel industry", *Journal of Hospitality and Tourism Management*, 21, 2014, pp. 34-43.
- [9] Wilkins, H., Merrilees, B., Herington, C., "Towards an understanding of total service quality in hotels", *Hospitality Management*, 26, 2007, pp. 840-853.
- [10] Zeithaml, V. A., Parasuraman, A., Berry, L. L., *Delivering quality service: balancing customer perceptions and expectations*, The Free Press, New York, 1990.
- [11] Zeithaml, V. A., Bitner, M. J., Gremler, D. D., *Services marketing: integrating customer focus across the firm*, McGraw-Hill, New York, 2013.



# Characteristics of Business Strategies and Management Systems within Automotive Industry

Andreas Kompalla

Jan Kopia

[andreas.kompalla@gmx.de](mailto:andreas.kompalla@gmx.de)

[j.kopia@gmx.net](mailto:j.kopia@gmx.net)

## Abstract

*The target of this research paper is an exploratory research regarding the characteristics of business strategies and respective management systems within the automotive industry.*

*Based on the evaluation of strategy publications of five car manufacturers there is a high degree of similarity regarding the duration of business strategies and its core targets (growth, customer satisfaction, sustainability and efficiency) within this branch.*

*Corresponding management systems supporting business strategies are mainly ISO based. The automotive industry contributed significantly to the popularity of ISO 9001 in the metal product sector and in line with ISO 16949 as well as 14001 they benefit in respect to process efficiency, involving suppliers and customers or managing workforce.*

**Key words:** strategy, system, automotive, Porter, ISO

**J.E.L. classification:** L10

## 1. Introduction

In order to coordinate all resources of a company and to satisfy all stakeholders enterprises need a guideline or strategy and a system, which helps to realize targets efficiently. This research paper concentrates on these two factors within the automotive branch as there are only few studies evaluating strategies and management systems within one analysis in respect to this branch.

Starting from core definitions and variants of business strategies and management

systems/certifications (chapter 2) these approaches will be evaluated within the automotive industry and respective characteristics as well as similarities will be highlighted (chapter 4).

## 2. Definitions and models

According to the VDA, the automotive industry consists of enterprises, which are producing vehicles, car parts or accessories. This research paper focuses on original equipment manufacturers (OEMs).

### 2.1 Business strategy

The term „strategy“ itself does have multiple definitions. Starting from the traditional approach according to *Mintzberg* presuming that all actions are defined within the strategic (intended) approach and no further tasks need to be realized. This traditional and very strict approach has been extended to the term of business strategy, which focuses rather on the guidelines and pattern of a strategy (5Ps: 5Ps: Plan, ploy, pattern, position, perspective) and the competitive advantage emerging out of strategies than on the strict traditional approach [1].

*Porter* focused especially on the power of differentiation and defined strategy as „particular configuration a firm adopts compared to its rivals.“ [2]

Management strategies are currently focusing more on the external factor analysis using wide spread methods such as scenario analysis, SWOT analysis or Porters five forces. Resource based planning became less important after the 50s and 60s. In these times highly diversified companies needed structure for distributing resources. In the era of *Jack Welch* (80s) strategic planning

seemed to be less important. *Welch* handed over reliability, responsibility and several strategic elements to his division directors.

According to *Andrews & Christensen* strategies cannot only be derived via external (market and environmental) circumstances and fixed for a long period without considering internal aspects (based on own resources and capabilities). Therefore it is important to have an integrated model considering multiple factors with the overall target to generate a competitive advantage. [3] *Johnson & Scholes* combine the internal, resource based view, and the external view as they define strategy as the longterm „direction scope“ in order to use of internal resources in order to meet the needs of external stakeholder and markets. [4]

## 2.2 Management System Standards

Management systems standards have been adopted by organizations worldwide. These standards were established to create concepts, guidelines, principles and certain criteria for establishing, operating and improving all processes with which an organization achieves its goals.

Beside Total Quality Management (TQM), which played a major role in the 1980s and 1990s, and Kaizen, ISO certification grew a lot within the last 20 years. Most of the standards went through a constant development over the last decades including very common standards as ISO 9001 and ISO 14001 which are being used by over 1.4 million companies worldwide (see table 1). The top ISO certifications are for the following organizational goals: quality (ISO 9001), environment (ISO 14001), health and safety (ISO 45001 / OHSAS 18001), information security (ISO 27001), Food Safety (ISO 22000), and quality management for automotive related products (ISO/TS 16949).

The strong growth of ISO 50001 of 40% can be explained by the German focus on energy safety management since most of the newly acquired ISO 50001 certificates are being acquired by German companies. Another interesting growth rate is the ISO 22000 standard which is for food safety management system standards which do have a very high growth rate in North America and Greece in 2014.

Table 1: ISO certificates worldwide comparison 2013/2014

Source: ISO, 2015 [5]

The number of certificates of most popular management system standard ISO

Standard	number of certificates in 2014	number of certificates in 2013	evolution	evolution in %
ISO 9001	1 138 155	1 126 460	11 695	1 %
ISO 14001	324 148	301 622	22 526	7 %
ISO 50001	6 778	4 826	1 952	40 %
ISO/IEC 27001	23 972	22 349	1 623	7 %
ISO 22000	30 500	26 847	3 653	14 %
ISO/TS 16949	57 950	53 723	4 227	8 %
ISO 13485	27 791	25 655	2 136	8 %
ISO 22301	1 757			
<b>TOTAL</b>	<b>1 609 294</b>	<b>1 561 482</b>	<b>47 812</b>	<b>3 %</b>

9001 only went up by one percent in 2014. The ISO states that “growth has certainly plateaued since the boom times two decades ago, reflecting the current economic uncertainty in the world. Moreover, in countries with a longer-established tradition of certification, many of the largest companies are already certified and are branching out to more specific standards. The prevailing situation is expected to improve, however, as markets pick up and with the introduction of the new version of ISO 9001” [6]. The new version of ISO 9001:2015 will be based on a new overlaying structure called Annex SL which will be the basis for all ISO management system standards of the future. The main reason for that is the need for integration of different management system standards within organizations especially because many organizations use more than one management system standard at the same time. This increases the importance of integrated management strategies in order to meet the reality of business globalization in a sustainable fashion [7].

Many large corporations need to establish environmental management systems (EMS) and choose to do that using the ISO 14000 standards. ISO 14000 has become a very important standard in that field. The ISO 14000 standards describe the components and characteristics of an effective system for managing a corporation's environmental impacts [8].

The ISO/IEC 27001:2013-Standard (Information Security) is the ISO standards which help organizations to keeping information assets secure. According to ISO/IEC 27001 is a very common standard providing requirements for an information security management system (ISMS). It is

already based on the new structure and therefore the first high-level structure-based standard with which organizations can profit from. Around 45.000 companies were certified with 27001 in 2013 and 2014 worldwide, 1221 in Germany [9].

Each management system standard focuses on different goals. Besides that standards follow the similar purpose to make it easier for organizations to establish, operate and improve processes necessary for that specific goal which means that the product or service is improved. The first ISO 9000 standard (1987) stated: "To achieve and sustain good economic performance through continual improvement in the customer specification and the organizational system to design and produce the product or service to satisfy the user's needs or requirements".

Management system standards have various benefits to the organization. In an extensive literature research *Tari* [10] compared many different scientific papers, which analyze the benefits of the management system standards ISO 9001, and 14001. The conclusion is that the standards are mainly beneficial to organizations. Most benefits "are improved efficiency and profitability, improved customer satisfaction, improved relationship with staff and image. Other benefits analyzed for ISO 9001, although to a lesser extent, are market share, sales and product quality".

Management system standards constitute an important part of the business strategy of an organization.

### 3. Research Methodology

This exploratory research paper describes and compares business strategies and Management systems based on a selection of car manufacturers within different segments. Via a set of fixed criteria, relevant business strategies will be described and similarities will be highlighted.

Corresponding Management Systems are evaluated based on databases and existing literature analysis.

### 4. Characteristics in automotive industry

The Automotive global strategy is based on several sub systems. The global strategy

controls it's sub systems and generates output based on inputs. Within automotive industry especially the production strategy has an important role leading to efficient use of production material via Computer Aided Manufacturing or Computer Aided Design. This research paper focuses on the overall business strategy itself.

### 4.1 Characteristics of Business strategies within automotive industry

This chapter of the research paper evaluates the business strategies of different Original equipment manufacturers within the automotive branch. BMW and Daimler represent two car manufacturers of the premium segment (which are now also starting to produce low budget cars for a mass market). General Motors, Volkswagen and Toyota belong to the mass sales segment focusing on high volumes and consisting of a vast amount of several smaller brands.

Focusing on the first criteria of *strategy initiation* there are similarities between Volkswagen and BMW which announced their business strategy "Mach18" (in 2008 adjusted to "Mach 18+") and respectively "One" in 2007. VW published its business strategy just after the setting up of the former CEO Prof. Winterkorn in dependence on the existing Audi strategy "Route 15". Based on a competitor analysis defined targets have been identified in order to become number one in several rankings and especially to overtake the number one competitor in this segment, Toyota. Based on the vast amount of brands, which belong to the Volkswagen group, this strategy was applied but customized (with unique slogan and unique targets) to each member of the group.

Figure 1: Volkswagen group strategy "MACH 18"



Source: VW annual report 2014 [11]

In the same year as Volkswagen also BMW announced its current corporate strategy

„Number One”. Intermediated targets have been defined for they year 2012 and final goals for 2020.

Figure 2: BMW coroporate strategy "Number One"

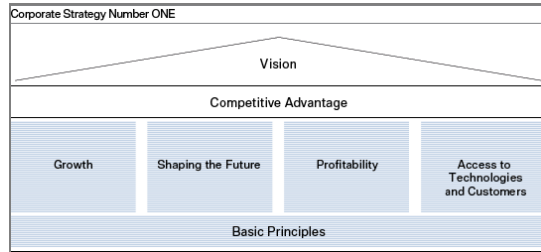

Source: BMW report 2013 [12]

Daimler initiated the strategy „Mercedes-Benz 2020” in 2011 after several years of falling behind in respect to its competitors Audi and BMW and in line with its 125th birthday. As especially sales was not increasing in same speed as in other brands the focus should be shifted to a growth strategy. Defined targets for specific stages have been defined.

Figure 3: „Mercedes-Benz 2020”

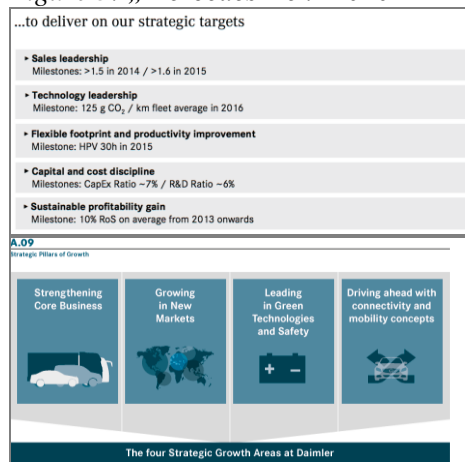

Source: Mercedes-Benz Division Day 2012 & Daimler Annual report 2014 [13]

Within the same year Toyota announced its global strategy and the *strategy 2020* for the European market.

Figure 4: Toyota Global Strategy

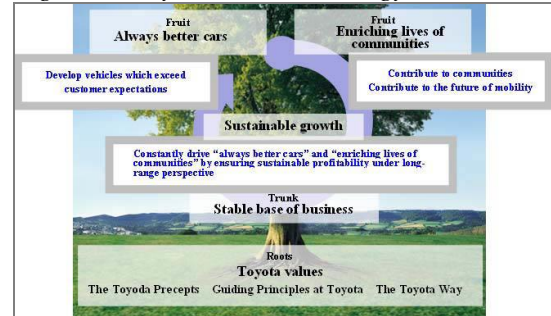

Source: Toyota sustainability report [14]

Figure 5: Toyota european strategy

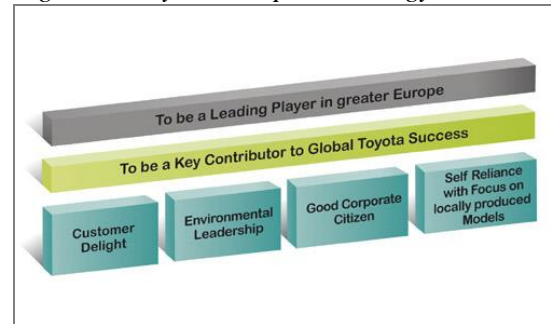

Source: Toyota europe homepage [15]

Specific to Toyota there is a strong focus on customizing and adapting strategies to the specific regions more than to its brands especially compared to its potential rival Volkswagen.

The third mass selling brand next to Toyota and VW is GM. After bankruptcy in 2011 GM announced in 2014 a detailed plan for future targets and core priorities.

Figure 6: GM strategic priorities



Source: General Motors 2014 [16]

The duration of the strategy (based on start and target year) is differing between the OEMs but compared to the average of 5 years in all businesses, all automotive strategies exceed this timeframe. As such a long period needs to be tracked for target progress, most of the automotive brands define intermediate goals.

Core topics within the strategies are growth, customer focus or customer satisfaction, efficiency and sustainability. Growth is represented by the target of sales

figures, customer focus is reflected by customer ratings, efficiency can be evaluated e.g. by profit and sustainability via emissions as well as average fuel consumptions. Based on the information provided by these brands it is not possible to identify a priority or weighting of specific targets.

By analyzing these business strategies according to internal (resource based view) and external factors automotive enterprises do focus both on customer satisfaction as well as internal resources. E.g. Volkswagens „MACH 18” strategy is focusing on employee satisfaction and on customer and growth targets. Toyota is extending this view to the society or community itself. The resource based aspect of technology leadership can be found especially at GM, Mercedes and BMW. In order to realize these targets management systems need to be implemented.

#### 4.2 Characteristics of management systems within automotive branch

The automotive branch uses ISO management systems but also other management systems. Most of the companies have implemented quality management systems, which are compatible with ISO 9001, 14000 and ISO/TS 16949 standards but also TQM and Kaizen [17] as well as the Malcolm Baldrige Criteria for Performance Excellence, the EFQM Excellence Model [18]. In fact the automotive industry is responsible for the enormous growth rate of ISO 9001 and 16949 certification within the basic metal and fabricated metal product sector [19].

Very important is the standard ISO/TS 16949 as the standard for quality management in the supply chain (growth rate by 8% in 2014 lead by china). It became even mandatory in the automotive sector, especially in Original Equipment Manufacturers (OEMs) in North America [20]. This is also valid for the market outside OEM as Singh suggested [21]: the automotive industry and its organization in “tiers” especially the aftermarket or replacement market is a very big. in addition global OEMs are interested in having all of their sub-contractors ISO/TS 16949 certified.

The focus of this ISO norm is on the prevention of defects which plays an

important role in the entire automotive production supply chain including production of raw material, welding, heat treatment, painting, assembly of components etc. The standard originated from the ISO 9001 and was extended with special requirements of the automotive industry in different countries by the International Automotive Task Force (see figure 1).

Figure 1: Origins of the ISO/TS 16949 standard

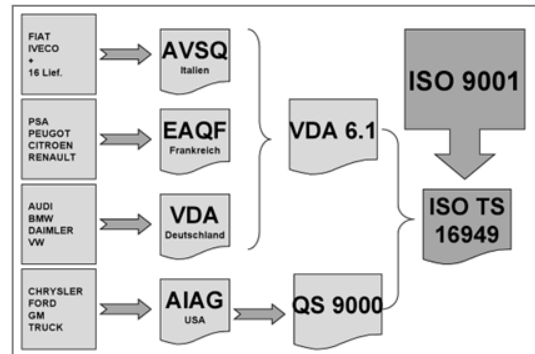

Source: [22]

According to ISO the ISO/TS 16949 standard is number three when it comes to the amount of certificates worldwide in 2014. In his study in the polish automotive industry Hys [17] came to the same conclusion.

Table 2: Management system standards certifications until 2014 in the automotive industry

No	Year	2004	2005	2006	2007	2008	2009	2010	2011	2012	2013
1.	TOTAL	10019	17047	27999	35198	39320	41240	43946	47512	50071	53723
2.	Africa	144	316	342	415	447	440	447	472	464	479
3.	Central/South America	394	734	1270	1383	1454	1476	1531	1575	1581	1585
4.	North America	4517	4571	5230	5929	5903	5411	5217	5334	5410	5592
5.	Europe	3212	6290	8943	10159	10771	10533	10624	10891	11017	11263
6.	East Asia and Pacific	1479	3884	9983	14569	17719	19910	22378	24968	26985	29831
7.	Central and South Asia	226	956	1593	2016	2260	2672	2991	3388	3817	4260
8.	Middle East	47	296	638	727	766	798	758	884	797	713

Source: [5]

In a survey of 68 decision makers in the polish automotive industry 60% had an ISO 9001-certification, 41.54% an ISO 14001, and 27.69% an ISO/TS 16949 certificate (followed by OHSAS 18001 of 15.38 %, Kaizen with 10.77%, TQM with 7.69%, and ISO 27001 with 3.08%. The following quality management system methods were used:

- Failure Mode and Effects Analysis – FMEA (35.38%),
- Balanced Scorecard – BSC (27.69%),

- Statistical Process Control – SPC (21.54%),
- Six Sigma method (20.00%),
- Mystery Shopping method (15.38%),
- Other methods

In worldwide comparison the Asian-Pacific area grew mostly during the last years considering the number of automotive certificates. A significant part of the production in the automotive industry was moved into the East Asia and Pacific territories. Today most of the management system standards in the automotive industry are therefore being established in the area East Asia and Pacific (see table 2).

In Europe this field is lead by Germany, Italy, France, Spain, and Turkey (comparison of ISO/TS 16949 certifications in Europe between 2004 and 2014). Compared to international production of motor vehicle this is a coherent image: table 3 shows that the top regions with the highest growth rate are within the East Asian and Pacific region as well as India and the United States (slowly decreasing). This trend did not change very much in the following years. In 2015 the top ten list is lead by china, followed by the USA, Japan, Germany and South Korea. [5]

In a study Franceschini [23] compared the top 10 car manufacturers against the number of ISO/TS 16949-certificates. 77.21% of the certificates worldwide were related to the top 10 manufacturers.

The growth rate of the numbers of certificates is a result of the increasing competition, insistence of multinational buyer-firms, and the government assistance ([9]; [24]).

Table 3: Motor vehicle production 1996-2006 in 1000 units and growth rate

	1996	1998	2000	2002	2004	2006	Growth rate (%) <sup>a</sup>
China	1,240	1,628	2,009	3,251	5,071	7,272	19.3
India	541	535	867	892	1,511	1,876	13.2
Republic of Korea	2,354	1,787	2,858	3,148	3,469	3,840	5.0
France	2,359	2,923	3,352	3,693	3,666	3,164	3.0
Brazil	1,813	1,547	1,671	1,793	2,210	2,597	3.6
Mexico	1,222	1,460	1,923	1,805	1,555	2,043	5.3
Russian Federation	1,029	1,021	1,203	1,220	1,388	1,495	3.8
Germany	4,843	5,727	5,527	5,145	5,570	5,818	1.8
Spain	2,412	2,826	3,033	2,855	3,012	2,776	1.4
Canada	2,397	2,570	2,962	2,629	2,712	2,544	0.6
Japan	10,346	10,050	10,141	10,258	10,512	11,484	1.0
United States	11,832	12,003	12,774	12,280	11,988	11,351	-0.4
United Kingdom	1,924	1,976	1,814	1,821	1,856	1,650	-1.5
Italy	1,545	1,693	1,738	1,427	1,142	1,212	-2.4

Source: [25]

The core idea of the ISO/TS 16949 certification is to improve the production of

automobile parts and related services. Several benefits are identified in scientific literature which is very similar to the benefits of studies only focusing on ISO 9001 ([18]; [6]). It improves the capabilities “supporting mentality of top management”, “Managing Workforce”, “Involving suppliers”, “Involving customers”, “Controlling and managing process”, and “Designing products/services”. “ISO/TS 16949 eliminates redundancy, cost and administrative burdens imposed by multiple standard formerly mandated in various geographic regions”, ([18] p. 496). *Sroufe et al.* [26] suggested that the ISO/TS-16949 registration has impact of the quality image to potential customers. It also improves on-time delivery and reduces decline in defective parts. Another study of Bevilacqua et al. [27] found that the norm results in a consolidated market position of the firm, and also creates higher product quality and plant performance. The same result is presented by Mohamad et al. [28] who evaluated automotive companies in Malaysia.

It can be said that the business strategy of automotive firms are very often supported by management system standards, especially the standards ISO 9001, and ISO/TS 16949 each of them realized with different methods.

Research shows that the use of these standards improves several aspects of these companies regarding overall quality in the production process, which makes the use of such a standard an important aspect in the business strategy.

## 5. Conclusion

Comparing the business strategies within the automotive industry several similarities can be identified. All business strategies contain fixed intermediate and/or final targets for sales figures or profit (return on sale). They focus on growth, customer satisfaction, sustainability and efficiency. Strategy targets are defined for a relatively long timeframe.

There is a high degree of similarity within the Management systems with respect to ISO standards.

## 6. References

- [1] Mintzberg, H., “The Rise and Fall of Strategic Planning“, *The Free Press*, New York, 1994

- [2] Porter, Michael E., "Competitive Advantage: Creating and Sustaining Superior Performance", *Simon and Schuster*, 2008
- [3] Kenneth, R. Andrews, "The concept of corporate strategy", 3rd edition, *Homewood Illinois*, Dow Jones , 1978
- [4] Johnson, G. , Scholes, K. , Whittington, R., "Fundamentals of strategy", *Pearson Education*, 2009
- [5] ISO, 2015 a, The ISO Survey of Management System Standard Certifications – 2014, ISO
- [6] [www.oica.net](http://www.oica.net), accessed 24.10.2015
- [7] Rebelo M F (2011) Contribution to the structuring of a model of integrated management system QES. Master Thesis. Polyt Inst Cavado Ave. Portugal
- [8] Tibor, T. and Feldman, I. (1996) ISO 14000: A Guide to the New Environmental Management Standards. Irwin, Chicago
- [9] ISO, 2015 b, <http://www.iso.org/iso/iso-survey>, accessed 23.10.2015
- [10] Tarí, J.J., Molina-Azorín, J.F., & Heras, I. (2012). Benefits of the ISO 9001 and ISO 14001 standards: A literature review. *Journal of Industrial Engineering and Management*, 5(2), 296-322. <http://dx.doi.org/10.3926/jiem.488>
- [11] <http://annualreport2014.volkswagenag.com/group-management-report/goals-and-strategies.html> , accessed 28.10.2015
- [12] [http://www.bmwgroup.com/d/0\\_0\\_www\\_bmwgroup\\_com/investor\\_relations/corporate\\_events/\\_pdf/2013/Charts\\_Dr\\_Reithofer\\_BPK\\_2013\\_d.pdf](http://www.bmwgroup.com/d/0_0_www_bmwgroup_com/investor_relations/corporate_events/_pdf/2013/Charts_Dr_Reithofer_BPK_2013_d.pdf), accessed 20.10.2015
- [13] [https://www.daimler.com/Projects/c2c/channel/documents/2141471\\_daimler\\_mbc\\_day\\_20120329\\_01\\_zetsche\\_overview.pdf](https://www.daimler.com/Projects/c2c/channel/documents/2141471_daimler_mbc_day_20120329_01_zetsche_overview.pdf), accessed 01.11.2015  
<http://ar2014.daimler.com/to-our-shareholders/objectives-and-strategy>, accessed 05.11.2015
- [14] [http://www.toyota.eu/sustainability/vision\\_strategy/vision\\_strategy/Pages/default.asp](http://www.toyota.eu/sustainability/vision_strategy/vision_strategy/Pages/default.asp), accessed 24.10.2015
- [15] [http://www.toyota.eu/sustainability/vision\\_strategy/Pages/default.aspx](http://www.toyota.eu/sustainability/vision_strategy/Pages/default.aspx), accessed 5.11.2015
- [16] <http://media.gm.com/media/us/en/gm/news.detail.html/content/Pages/news/us/en/2014/Oct/1001-gm-plan.html>, accessed 20.09.2015
- [17] Hys Katarzyna, (2015), Tools and methods used by the Polish leading automotive companies in quality management system. Results of empirical research
- [18] Ostadi, B., Aghdasi, M. and R.B. Kazemzadeh (2010), 'The impact of ISO/TS 16949 on automotive industries and created organizational capabilities from its implementation', *Journal of Industrial Engineering and Management* 3(3): 494–511.
- [19] Franceschini, M. Galetto and P. Cecconi, (2006), A worldwide analysis of ISO 9000 standard diffusion Considerations and future development, *An International Journal Vol. 13* No. 4, 2006 pp. 523-541
- [20] Lin, W.-T., Liu, C.-H., Hsu, I.-C., & Lai, C.-T. (2004). An Empirical Study of QS 9000 in the Automobile and Related Industries in Taiwan. *Total Quality Management*, 15(3), 355–378
- [21] Singh, Neelam (2010b), 'Original Equipment Supply Chains and Auto Component Exports from India', in N.S.
- [22] Brückner, Claudia, (2009), *Qualitätsmanagement für die Automobilindustrie, Grundlagen, Normen, Methoden*, Symposium Publishing GmbH, ISBN-13: 978-3939707202
- [23] Franceschini F., Galetto M., Maisano D. and L. Mastrogiacomo (2011), 'ISO/TS 16949: Analysis of the Diffusion and Current Trends', *Journal of Engineering Manufacture* 225(5): 735–745.
- [24] Oke, S.A. and O.E. Charles-Owaba (2007), 'Implementation of ISO-based quality management systems: a review of the literature', *International Journal of Productivity and Quality Management* 2(1): 81–111.
- [25] Timothy J. Sturgeon, Olga Memedovic, Johannes Van Biesebroeck, Gary Gereffi, Globalisation of the automotive industry: main features and trends, *Int. J. of Technological Learning, Innovation and Development*, 2009 Vol.2, No.1/2, pp.7 - 24
- [26] Sroufe, R. and S. Curkovic (2008), 'An examination of ISO 9000:2000 and supply chain quality assurance', *Journal of Operations Management* 26(4): 503–520.
- [27] Bevilacqua, M., Ciarapica, F.E., Giacchetta, G. and B. Marchetti (2011), 'Overview on the application of ISO/TS 16949:2009, in a worldwide leader company in the production of stainless steel tubes for automotive exhaust systems', *International Journal of Productivity and Quality Management* 7(4): 410–439.
- [28] Mohamad, D., Deros. B.M, Wahab. D.A., Ismail. A. R. and Ling, (2010), CASE STUDY OF ISO/TS16949 APPLICATION

IN AUTOMOTIVE INDUSTRY, National  
Conference in Mechanical Engineering  
Research and Postgraduate Studies, Faculty  
of Mechanical Engineering, UMP Pekan,  
Kuantan, Pahang, Malaysia; pp. 559-563



# Study Regarding Consumer Protection and Satisfaction on Tourism Services Market. Case Study: Romania Versus France

Anca Madar

*Transilvania University of Braşov, Faculty of Economic Sciences and Business Administration, Department of Marketing, Tourism and International Affair*  
[madaranca@gmail.com](mailto:madaranca@gmail.com)

Nicoleta Andreea Neacşu

*Transilvania University of Braşov, Faculty of Economic Sciences and Business Administration, Department of Marketing, Tourism and International Affair*  
[deea\\_neacsu@yahoo.com](mailto:deea_neacsu@yahoo.com)

## Abstract

*In this paper we have chosen to compare, the institutional framework of Consumer Protection on tourism, both in Romania and in France, which, according to the World Tourism Organization analyses, ranks first in the top tourist destinations. It is also analysed the evolution of tourism using several indicators such as the number of tourists and the number of units registered in Romania and France. To highlight how tourist services consumers are protected in these countries, have conducted research among tourists, by applying SERVAQUAL method. The permanent organization of marketing researches among customers represents the basis of the development, improvement and performances expected at the level of each company. Research suggests that the perception of the overall quality of hotel services in both countries is negative.*

**Key words:** consumers, tourist services, consumer protection, research, services quality.

**J.E.L. classification:** D 18, Z 32

## 1. Introduction

Today, consumers have a wide choice of tourism products and services, thereby increasing considerably with the integration of Romania into the European Union.

There are times when economic agents due to their economic and financial power, bring to market products or tourist services which do not satisfy the requirements,

consumers having not the objective possibility of consciously perceive the true quality of services and products purchased and make a choice in full knowledgeable, due to lack of information that exists to the requirements of a particular product or tourist service. Thus, consumers may be at risk of purchasing a product or a service that can affect their lives, safety, health or the legitimate rights and interests.

In this regard, this paper compares the framework in which evolved Consumer Protection on tourism services, both in Romania and in France, a country which according to the World Tourism Organization analyzes, ranks first in Europe in top tourist destinations, and analyze the tourists' satisfaction on hotel services in the two countries using SERVQUAL method.

## 2. Conceptual issues regarding tourism services

Travel services are often defined "as a set of activities aimed at meeting the needs of tourists during the move and in this connection"[1]. Thus, activities that give content to tourism services aim to cover some regular, daily needs (rest, food), but there are also activities which presents specific characteristics of tourism and particular forms of its manifestation.

The role and importance of tourism services is reflected in the fact that they must be designed and organized to provide conditions for the recovery of labor capacity, stimulated with enjoyable and instructive leisure time, and after consumption of the tourism product (service), the individual

obtain an addition of information, knowledge and new skills [1].

Travel services are characterized by a wide range of features (special features) caused by the special nature of supply and tourism demand, the way how they are correlated and the conditions in which they are acts of sale. These features demonstrate both the complex nature of touristic services and differentiated role in combining them to become components of tourism products offered in different forms of tourism.

### 3. Presentation of Romania and France tourist areas

#### 3.1. Presentation of Romania

Romania has a rich tourism potential and natural resources in order to practice various forms of tourism. It is noted in this regard opportunities for adventure tourism, provided by national rivers, the caving-tourism, equestrian tourism, cruise tourism on the Danube, rural tourism, cycle tourism opportunities to practice but also out-of-road competitions .

The main tourist developed regions of Romania are presented in Table 1:

*Table 1. Tourist regions in Romania*

Regions of tourism development in 2013	Number of tourists
TOTAL	7.943.153
Regiunea CENTRU	1.859.853
Regiunea BUCURESTI - ILFOV	1.437.737
Regiunea SUD-EST	1.166.418
Regiunea NORD-VEST	899.370
Regiunea NORD-EST	756.006
Regiunea VEST	684.383
Regiunea SUD-MUNTENIA	679.360
Regiunea SUD-VEST OLTENIA	460.026

Source: [www.INSSE.ro](http://www.INSSE.ro)

Analyzing the data in the table above we can see that the area with most visitors is the Centre with a total of 1,859,853 visitors in 2013, followed by Bucharest-Ilfov region with 1,437,737 tourists and South East with 1,166,418 people who visited the region.

The main forms of tourism in the Central Region are mountain tourism, spa tourism, cultural tourism and agro tourism.

In Bucharest-Ilfov region a special attraction is the possibility of fishing, water sports, hunting and access to cultural heritage and ancient Orthodox monasteries with their museums, being developed different types of tourism such as cultural tourism, religious tourism, sports, adventure, and the business.

Tourism in the South East region is characterized by the existence of specific natural resources, such as the Black Sea and the Danube Delta (the area is known on international level due to seaside tourism), renowned spas in the country and abroad, and agro - touristic pensions, particularly in mountain areas in Vrancea and Buzau and the Danube Delta. Also in the region it is present ecumenical tourism, in particular by monasteries in Northern Dobrogea, in the mountains of Buzau and Vrancea, Galati area, and also the cultural tourism present by cultural vestiges: archeological sites, memorial houses.

Due to favorable conditions, landscape, air and water purity within mountain areas of Bacău, Neamț and Suceava and the priceless cultural and religious heritage existing, North East region has a relatively high tourism potential, which can be compared to other popular tourist destinations in the country and abroad.

#### 3.2. Presentation of France

France possesses a wide variety of terrain, from plains in north and west to south mountain ranges (Pyrenees) and southeast (the Alps), the latter having the highest point in Western Europe, Mont Blanc (4.810 meters) [2], thus being possibility of developing a large number of types of tourism.

Tourism attractiveness is explained by the wide variety of points of interest and their huge number, plus the diversity of landscapes, the richness of heritage and temperate climate and access facilities, tourism infrastructure and transport, which are very well developed.

Table 2 presents the main tourist regions in France.

*Table 2. Tourist regions in France in 2013*

Tourist Regions	Development	Number of tourists (millions)
Île-de-France		67.405
Provence-Alpes-Côte d'Azur		21.635
Rhône-Alpes		18.498
Aquitaine		8.658
Midi-Pyrénées		8.197
Languedoc-Roussillon		7.487
Bretagne		6.868
Alsace		6.382
Pays de la Loire		6.181
Nord-Pas-de-Calais		5.734
Centre		5.565
Bourgogne		4.767

Source: [www.INSSE.fr](http://www.INSSE.fr)

Île-de-France is the most populous region. In the north of the region is known as the Beauce area, one of the two historic areas that formed the France [3]. This region is the most important tourist destination of France because the county capital is also the country capital, Paris, being the most sought destination on global level.

Paradise Provence Alpes Côte d'Azur region comprises snowy peaks of the Alps, which descends eastward to the sea coast and extending west to the Rhone Basin, having crossed Central Highlands of the deepest canyons in Europe [4].

Aquitaine, with the capital of Bordeaux, is one of the great historical regions of France, being also one of the various French regions, cultural tourism being representative for this area, but also the wine tourism.

The largest region in France, Midi Pyrénées, is a predominantly rural area where rural tourism is predominantly developed and known. The region is sprinkled with many beautiful and interesting places such as castles, towns and villages charming medieval wine vineyards, sunny beaches of the Mediterranean and the Pyrenees ski slopes [5].

Brittany, located in the northwestern corner of France, is one of the most important historical regions of the country. The "most Atlantic" between French regions, enjoys a mild climate, warmer than other regions adjacent to Atlantic coast and drier in terms of rainfall.

Alsace is the Germanic region of France. With its crowded settlements built half-timbered houses, painted in bright colors, with steep roofs, Alsace differs from other regions of France.

### 3.3. The evolution of tourism in Romania and France

From the analysis of Table 3 can be noticed that the number of tourists has fluctuated greatly during the period 2000-2013. Thus, if by 2007 it was registered a growth in the two countries, obvious in France, ranging from 77 million to 80 million, an increase of more than 3 million tourists and about as obvious Romania, ranging from 5 million to approximately 9 million in 2008, the highest number of tourists registered in Romania, in this period of 13 years. However, with the installation of the economic crisis, both countries have suffered, France since 2008, dropping to about 76 million tourists arrivals and Romania, falling to just 7.5 million. After year 2011, the number of tourists began to rise, reaching in 2013 in France, 84 million tourists, the largest number of tourists recorded by then and in Romania, 8 million tourists.

Table 3. Evolution of the number of tourists in the period 2000-2013

Comparison of changes in the number of tourists arriving in the two countries during the period 2000-2013										
	2000	2005	2006	2007	2008	2009	2010	2011	2012	2013
France	77.190	74.988	77.916	80.853	79.218	76.764	77.648	81.550	83.051	84.726
Romania	5.264	5.839	6.037	7.722	8.862	7.575	7.498	7.611	7.937	8.019

Source: *INSSE.ro, INSSE.fr*

In Figure 1 we can see a significant difference on the number of tourists arriving

in the two countries. While in Romania, millions of tourists come annually in France are tens of millions crossing the length and breadth of the country during a year.

*Figure 1 The number of tourists arriving in France and Romania during 2000-2013*

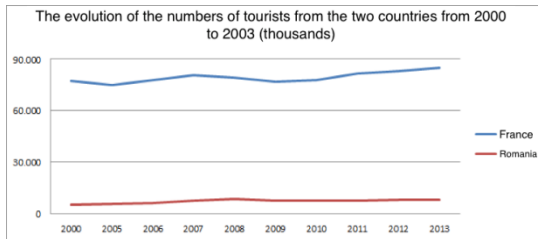

The upward trend in the number of tourists, but also in the number of units (Figure 2), prompting the need for robust regulations on the quality of tourist services; thus appears various laws that are intended to standardize the various tourist services.

*Figure 2 Evolution of tourist accommodation establishments in Romania and France in the period 2001-2012*

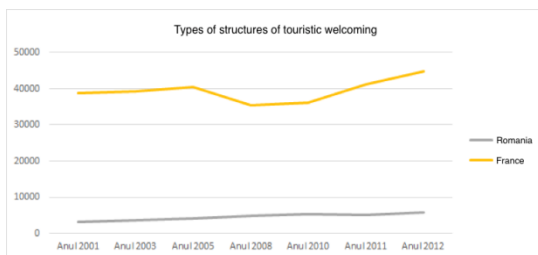

#### **4. The legislative framework on consumer protection in tourism services in Romania and France**

##### **4.1. The legislative framework in Romania**

Tourist services and the need to align to the existing Community regulations, have imposed introduction in Romanian legislation of new institutions capable of responding to contractual practices which already operates in tourist services [6].

From the point of view of the consumer, protection may be divided into stages according to the tourist consumption [7]:

1. Protection during the tourist product choice;

2. Protection in the purchase phase of tourism product;

3. Protection in the phase of consumption.

In each of these phases, Consumer Protection should refer to the basic components of the tourism product, transport, accommodation, food, entertainment to whom must be added, for the sake of practical utility, information and reservation.

In the choice and purchase phases of tourism product, the most important regulation governing the relationship between the client and the provider (travel agencies and hotels) is the Law. 631 of 11.16.2001 on the marketing of travel packages, transposing Council Directive 90/314 of 13 June 1990 on package travel, package holidays and package sum.

In buying phase an important element are the promises made to customers in terms of accommodation and food, and the most important regulation is the methodological norms from 06/28/2002 regarding the classification of touristic structures that establish the criteria for the classification of restaurants and accommodation structures.

The main public organizations involved in protection of tourism services consumer are:

a. *The National Authority for Consumer Protection (NACP)*

This authority is a public institution and operates as a specialized body of central public administration, participating together with other institutions in the field of consumer's protection and consumer's NGOs, in the development of the consumer protection strategy, ensuring its correlation with the existing one in the European Union [8]. The National Authority for Consumer Protection has the role to keep consumers informed about products and services that present risks to their health and safety or that may affect their economic interests;

b. *Consumer Protection Association (CPA)*

It is a nongovernmental, nonpolitical and nonprofit organization, established since 1990, which has as main objective the defense, promotion and representation by all legal means of consumer rights and interests in relations with businesses and institutions [9, 10].

c. *European Consumer Centre in Romania*

On the 1st January 2008 it joined the ECC-Net (European Consumer Centre Network) to assist EU citizens in cross-border shopping. The aim of the European Consumer Centre is to provide consumers with a wide range of free services, from information on their rights to giving advice and support in solving problems encountered in the European market (from renting a car, booking a package holiday or flight, to order products online) [11].

#### 4.2. The legislative framework in France

Consumer law in France is subordinate to the idea that the state knows best general interests and, therefore, the best approach is the consideration of consumer law as a separate branch of law. It includes regulations on consumer's right to be protected through information (there are different obligations for businesses and rules on advertising), the consumer's right to have freedom of contract (prohibiting certain practices, unfair terms and existence of the right of cancellation of the contract for goods and services bought online) and the consumer's right to have his rights defended in court through collective associations.

The most important public structures of consumer protection are [12]:

a. *Conseil National de la Consommation* was established to allow confrontation and consultation between representatives of consumer interests and corporate interests representatives in all situations covering consumer issues; of this body responds competent ministry and provide advice on draft laws and regulations is the only national structure.

b. *L'Institut National de la Consommation* – INC – is the body that addresses consumers' representatives to prepare the discussions, with help from technical advice to the institute; it performs tests and publicizes their own magazine for the consumers.

c. *General Directorate for Competition, Consumption and Repression of Fraud* - GDCCRF - is an administrative structure responsible for updating the political program of the consumers.

In France, there are a large number of consumer associations operating in all

spheres of protection, others only in specific areas such as tourism and services. They aim to defend the collective interest of the people and going to court to settle cases. Currently nearly 20 associations are recognized, the most important being the Union Fédérale des Consommateurs (UFC).

#### 5. Analysis of customer satisfaction on tourist services in Romania and France using the SERVQUAL method

To make a research among tourists, SERVAQUAL method was chosen to measure their level of satisfaction with regard to hotel services. We think that this method is most relevant because it is most commonly used to determine the quality level of service, but also because the results can be analyzed in comparison to draw conclusions on the perceived quality of hotel services in the two countries. Analysis was conducted on the hotel services, which have the largest share of tourism demand in the two countries. The permanent organization of marketing researches among customers represents the basis of the development, improvement and performances expected at the level of each company. More on the tourism market these actions are compulsory, as changes in the content of tourism demand are permanent and fast most often [13].

The hypotheses from which we have started in conducting the research are:

- H1. The attributes of hotel services quality split across multiple size;
- H2. Expectations have a direct and indirect impact on perception after consumption of the service;
- H3. Hotel customer experience has a significant influence on the level of perceptions;
- H4. The results will be significantly different in the two countries, France being superior regarding the quality of hotel services.

Following the determination of hypotheses were outlined six main objectives:

- a. Determination of attributes of hotel services quality that has the greatest impact on customer satisfaction in the two countries;

- b. Assessment of tourist's expectations and perceptions about the services and amenities offered by the hotel units;
- c. Determination of the dimensions of quality that have the greatest impact on customer satisfaction in the two countries;
- d. Determining the size of the average quality of the service in the two countries;
- e. Determining the overall quality of the hotel services;
- f. Determination of the significant differences between the two analyzed countries;

The SERVQUAL method can determine the level of customer satisfaction by analyzing perceptions and expectations related to service, in reference to a range of different service features. In this research, it used the classical method of analysis being analyzed five dimensions: tangibility, reliability, responsiveness, trust and empathy.

Questionnaire was applied in two forms, a questionnaire relates to hotel services in France and other hotel services in Romania. The questionnaire comprises two parts, the first part being represented by different statements about customer expectations about service quality, and the second part contains statements about their perceptions after the service. We used ordinal scale, subjects were placed in a position to assess various attributes according to their preference, by choosing one of the scale levels, being expressed in figures such as the score 5 - the highest of expectations and the score 1-a very low expectations. It was conducted a research among young people, aged 20-25, from Braşov who traveled in France and in Romania and stayed in a hotel at least once.

We believe that this ensures certain homogeneity in terms of research, because the population studied has approximately similar income, thus moving towards the same types of units. The research was conducted on 10 subjects, of which 2 persons were male, the rest female.

In the first part of the analysis was calculated and determined quality of service for each dimension separately for each country as follows:

### 5.1. France

a) Tangibility - average quality of service for this dimension is -0.22.

The biggest negative difference between perceptions and expectations was recorded in the statements: "The quality of food and beverages meet the needs of tourists" and "Within the hotel there are adequate facilities for leisure tourists (pool, gyms etc.)". Tourists consider important these issues, but not greatly respected hotel owners, there are still some problems with the quality of food and the lack in the variety of leisure facilities. On the other hand, the biggest positive difference between perceptions and expectations was recorded in the statement that „The hotel has facilities for people with disabilities ". So even if surveyed people do not consider it very important, in France is implemented a support system for people with disabilities and there are strict rules that must be met by each operator.

b) Reliability - average quality of service for this dimension is -0.5.

The biggest difference between perceptions and expectations was recorded on the statement "The hotel program is flexible so that the tourists needs can be met promptly ", which shows that hotels do not have a flexible schedule, allowing to satisfy every need of tourists. In the other direction, a less significant difference was recorded on the statement "The staff offers all the services promised to the tourists", they considering that the hotel offers guests all the promised services, which meant a high level of trust of the people.

c) Responsiveness - average for this dimension of quality of service is -0.53.

A big difference between perceptions and expectations is observable to the question "The hotel employees are always accessible to answer questions from tourists". The hotel employees are not easy to find all the time to answer to the tourist's questions, depriving them even at night in some hotels. On the other hand, the smallest difference between perceptions and expectations was recorded on the statement "The hotel employees respond quickly and without delay to the tourists requirements," which makes us think that when they are during working hours, employees are willing to helping clients, which was appreciated by customers.

d) Trust - average quality of service for this dimension is -0.36.

A big difference is noticeable to the statement "The employees of the hotel

inspires confidence to the tourists", hotels travelers considering that employees do not inspire as much confidence as it should be. No difference was recorded regarding perceptions and expectations of the question: "The hotel has a good reputation and trust" so customer expectations are met.

e) Empathy - average quality of service for this dimension is -0.23.

It can be noticed a big difference to the statement "The hotel employees understand the specific needs of tourists and treat them appropriately," the people questioned considering that hotel employees do not understand the specific needs of tourists and not treat them according to their expectations. A positive difference is noticeable to the statement "Employees given individual attention to each tourist hotel" where we can see the degree of satisfaction of tourists on the attention received from employees.

Next, we calculated the overall quality of service, resulting in a negative value: -0.36, which means a customer complaint regarding the quality of hotel services, resulting the increasing number of complaints with about 10% in 2013.

Regarding the perceived quality of service, from a consumer point of view the study identifies three important dimensions that have a significant effect on satisfaction: confidence in the service, the attention given to employees but also tangible elements. This result demonstrates that besides the material basis of tourism, according to the respondents, the factors that most influence customer satisfaction are the promises made by the bid and employees' attitude towards clients.

## 5.2. Romania

a) Tangibility - average quality of service for this dimension is -0.72.

This result highlights the researched population's dissatisfaction, related mainly to hotel employees, respondents considering that they are not sufficiently trained and the accommodation does not provide the possibility of organizing entertainment programs for tourists.

In contrast, the main issues that registered the lowest difference are: the fact that within the hotel facilities are intended to improve

the health (beauty salons, spa programs) and inside the hotel, the surveyed people were satisfied with the arrangement of the rooms, the equipment and decor.

b) Reliability - average quality of service for this dimension is -0.94.

This value is mainly due to the fact that not all promised services are offered to the tourist; the hotel employees do not provide the required services on time, and not showing understanding for the tourist's problems.

c) Responsiveness - average quality of service for this dimension is -0.70.

The average value is negative. However, respondents are partially satisfied with the way the hotel staff are willing to help, to answer questions, which is permanently accessible, easy to find.

d) Trust - average quality of service for this size is -0.76.

The only aspect that highlights respondents' dissatisfaction is related to the fact that employees do not have the necessary abilities to solve the requirements of tourists. The respondents satisfaction is related to the fact that accommodation unit has a good reputation, is reliable and an important aspect that contributes to good performance of tourism services is that the hotel employees are polite to tourists, inspiring them confidence.

e) Empathy - average quality of service for this dimension is -0.83.

This negative value shows that respondents are mostly satisfied with how the employees of the accommodation unit understand their specific needs, treating them properly.

Looking to the overall quality of hotel services in Romania, we can see that surveyed people have a degree of dissatisfaction, the average being -0.79. This value is given especially to the customer dissatisfaction regarding reliability and empathy.

## 6. Conclusions

Research suggests that the perception of the overall quality of hotel services in both countries is negative. In the case of Romania the degree of dissatisfaction is greater, the greatest problems being the employee's inability to provide the promised service and

delay that happens, but also their inability to provide the requested service due to lack of training. All of these are reasons that can trigger the appropriate situations to call the Consumer Protection.

In each of these countries there are still problems with the quality of services offered and the need for presence and implementation of consumer protection regulations it is imperative both to protect the consumer but also for the positive development of quality offered.

On the tourist services market, Consumer Protection should refer to the basic components of the tourism product (transport, accommodation, food, recreation) on which should be added for the sake of practical utility, information and reservation.

Romania can learn from France to create certain persons associations intended to protect consumers and to help the ANPC with advice and situations.

*Transilvania University of Braşov*, 2014,  
*Vol. 7(56), No.2*, , pp. 70.

## 7. References

- [1] Ispas, A. *Tourism Economy*, Transilvania University of Braşov Publishing House, Braşov, 2010.
- [2] <http://www.slideshare.net/georgetoma16/franta-42619988>
- [3] <http://www.globi.ro/regiunea-centru-franta>,
- [4] <http://www.globi.ro/proventa-alpi-coasta-de-azur>,
- [5] <http://www.directbooking.ro/viziteazafranta.aspx?tip=regiuni&id=franta>,
- [6] <http://legestart.ro/protectia-consumatorilor-la-servicii-turistice>
- [7] Niţă, V. "Consumer protection in tourism-considerations about european and romanian regulations" in *Tourism Journal*, No. 2, 2006
- [8] [http://www.anpc.gov.ro/index.php?option=com\\_content&view=category&layout=blog&id=94&Itemid=9](http://www.anpc.gov.ro/index.php?option=com_content&view=category&layout=blog&id=94&Itemid=9)
- [9] <http://www.apc-romania.ro/ro/pg-despre-noi/MTAtMS0x.html>
- [10] Epuran, Gh. *Business Communication. Strategies, techniques, decision models*, Alma Mater Publishing House, Bacău, 2002
- [11] <http://www.eccromania.ro/articole/despre-noi/reteaua-ecc>
- [12] [http://store.ectap.ro/articole/457\\_ro.pdf](http://store.ectap.ro/articole/457_ro.pdf)
- [13] Băltescu, C. A. and Boşcor, D. "The Assessment of Hotel Services in Poiana Braşov Resort", in *Bulletin of the*



## Leadership for the Virtual Age

Paul Marinescu

*Faculty for Business and Administration, University of Bucharest*

[paulmarinescu1@gmail.com](mailto:paulmarinescu1@gmail.com)

George-Sorin Toma

*Faculty for Business and Administration, University of Bucharest*

[tomagsorin62@yahoo.com](mailto:tomagsorin62@yahoo.com)

Cosmin-Alexandru Ștefan

*Centre for Organizational Strategies and Leadership (CSOL-UB), University of Bucharest*

[cosmins.faa@gmail.com](mailto:cosmins.faa@gmail.com)

### Abstract

*Based on the tremendous advances made in IT&C, instantaneous communications around the world have become ubiquitous and extremely cheap. Sparked by these developments, more and more organizations began to change their cultures and started to rely on work done in a virtual environment, rather than in "brick-and-mortar" offices like before. The advantages for both employees and companies are numerous, and therefore this trend is clearly gaining momentum. This paper aims to analyze some of the elements that characterize virtual teams and virtual organizations, as they will clearly play an increasing role in tomorrow's business world. Another question we are aiming at answering is whether leadership in such an environment is different from a more traditional one, and if this is the case, to highlight what some of these differences might be.*

**Key words:** virtual leadership, virtual team, virtual organization, leadership

**J.E.L. classification:** M14

### 1. Introduction

The tremendous advances in Information Technology and Communications (IT&C) that occurred in recent years, have enabled a shift towards a more flexible working environment, one in which the employee is not tied to a "nine to five" work schedule, or even to an office, for that matter. While these developments brought about huge

advantages, ranging from the freedom workers enjoy in choosing the schedule that best fits their needs and shorter commute times, to the ability of an organization to put together the specific talent needed to complete a certain task, with disregard for geographical distances, they also present managers with a new set of challenges.

The general trend in the business world, following these technical developments, is towards "flatter" organizational designs, more flexible and adaptive systems, structures and processes, and an increase in team-based work [3].

One of the developments this trend led to was the emergence of virtual teams and organizations, which present a special set of challenges to leaders, as Ton Kunz, a principal in Shell Oil Co's Network Learning and Support Center, said about leading in this environment: "I'd be surprised if anyone has it figured out yet". [11]

The purpose of this paper is to explore some of these challenges, that leaders will likely face in the next, *virtual*, world. In order to achieve this goal we have focused on a literature review of some of the theories that best explain how virtual teams and virtual organization function, and on some of the challenges faced by the leaders and managers that work in this type of structures.

### 2. Virtual teams

A particular type of team, which has become increasingly popular in the recent period, is the virtual team which can be defined as "groups of geographically and/or organizationally dispersed co-workers that

are assembled using a combination of telecommunications and information technologies to accomplish an organizational task" [7].

The main three components that characterize any virtual team are: *people*, *purpose* and *links* [6]. People are the most important element of any team, the purpose is both the "glue" that keeps the team together as well the reason it exists, while the links represent the means of communication that allow team members to work together toward the common goal. According to Lipnack and Stamp's model each of this components can be further divided in three sub-components which, put together, form a "*strategic framework*" that can be used in efficiently and effectively managing a team [6].

In the case of people the sub-components are: *independent members*- because team members are selected solely for their abilities, and are likely to be engaged in other projects as well, their commitment to the team is only partial; *shared leadership*- it is very likely that each member was selected for his/her expert knowledge in a certain area of the project, and therefore it is almost certain that each of them will assume control of the team's work at a certain time during the project; *integrated levels*- each team operates inside one or multiple organizations, this means that will it holds a certain degree of autonomy, it also has to integrate its efforts with those from other parts of the organization.

The sub-components of the purpose area are: *co-operative goals*- because team members are selected from different departments, or even organizations, in order to ensure the success of a project it is imperative to formulate clear co-operative goals; *interdependent tasks*- because most of the tasks can only be completed using expertise from numerous team members, it is essential to ensure a co-operative work style; *concrete results*- because teams are created for a specific purpose, success can only be achieved by delivering those results.

Links are divided in: *multiple media*- because the lack of face-to-face interactions is one of the biggest drawbacks of virtual teams, it is essential to ensure that multiple means of communication are used, as each one has its advantages and shortcomings; *boundary-crossing interactions*- team

members can come from different areas or countries, as well as from different organizations, care should therefore be taken by managers to ensure that cultural and organizational differences are respected; *trusting relationships*- because team members are recruited for a specific project, can belong to different cultures and have limited face-to-face interactions at best, it is essential that leaders make every effort to ensure that mutual trust is achieved between members.

### 3. Virtual organizations (VOs)

A relatively recent development in the business world, stimulated by both the IT&C revolution and by organizational innovation, is the emergence of the so called Virtual Organization. A lot of effort has been invested in defining exactly what a VO is, definitions ranging from "*a temporary network of independent companies*" [1], to an "*organization in which workers are not physically but electronically connected*" [2], or "*a way of structuring, managing and operating dynamically*" [8], yet because each of this definitions focuses on one aspect of the VO, each tends to be rather restrictive.

For the purpose of this paper, we consider it useful to use a more inclusive approach, that is why we define a VO as being "*any organization with non-co-located organizational entities and resources, necessitating the use of virtual space for interaction between the people in these entities to achieve organizational objectives*" [9].

Some of the most important aspects in discussing VOs are the "*degree*" and "*dimensions*" of virtuality they each poses [9]. In this context the degree of virtuality refers to how intensive the use of IT&C is, while the dimensions refer to how extensive that use is, in other words, how much of the functions of an organization take place in a virtual environment.

Observing that in the study of virtual organization "*with research often looking at a single context or manifestation of virtuality at a time, practitioners do not have a comparable metric that they can use across several contexts*", Shekhar has created a framework aimed at allowing such comparisons to be drawn [9].

This model focuses on three "*directions*" of virtuality, based on what area of the activity takes place in a virtual environment: the *external customer (EC) direction*- concerning clients; the *internal customer (IC) direction*-concerning employees and other individuals within the organization; and the *value chain (VC) partner direction*- concerning all inter-organizational linkages (suppliers, partners, subsidiaries, service providers, and so on).

Another important dimension that Shekhar's model focuses is the "*granularity*" of virtuality, for each of the three directions introduced earlier; three levels of intensity are introduced: individual level, group level and entire category level. The advantage that the use of this model brings, is that it allows managers to compare different firms based on the level of virtuality they employ, as well as that it can be used as an instrument of strategic planning by the top management, as a sort of a roadmap towards the desire state for one's own organization.

#### 4. Leadership for the Virtual world

One very important question is, if leading in a virtual environment, regardless if we are talking about a team or a VO is different than leading in a classic team or organization. While it goes without saying that traditional leadership qualities are necessary, after all "*someone that can't manage a conventional team effectively, probably can't handle a virtual one, either*" [11]; if special skills are needed to be a virtual leader, and if so which are they, remains a subject for discussion.

After an extensive study conducted on virtual managers, perceived as being exceptional by their peers, as well as a questioner given to managers from different levels within organizations, Smith and Sinclair concluded that there are a series of common dangers associated with working in a virtual environment, the most important of which are: *feelings of isolation and communication difficulties*- because humans are used to face-to-face interactions, even the most advanced means of communication available lose some of the message transmitted (for example body-language, voice pitch, and so on), moreover small social interactions that make a big difference in the day-to-day work routine are removed (the "*water-cooler gossip*" for example);

*trust, which is a vital ingredient for success is harder to build*- work relationships tend to be build over time, through a lot of different interactions [5], if this "getting to know each other" phase is omitted, working as a team can be difficult; *technology is both an aid and a barrier to effective communication*- as previously stated while there are great advantages in a virtual environment, like instantaneous communication across space or ease in storage and retrieval, it also lacks a certain "*human touch*"; *issues around cultural differences can occur*- because every country has a different set of "*dos and don'ts*" misunderstandings or, even worst, conflicts can arise from even seemingly trivial things like the formal/informal way of writing an email; *psychologically virtual workers tend to become distanced from their organization*- it is hard to build a organizational culture if the day-to-day rituals that enforce it are absent, and of course physical distance is a great deterrent in enforcing them[10].

The conclusion of the study mentioned above, as well as a lot of the literature seems to identify significant differences between working in a "*brick-and-mortar*" office as opposed to a virtual one. It becomes obvious than, that in order to achieve success a virtual leader must be able to tackle this challenges leaders have to posses certain skills: emphasis on results and not activities, great communication skills, the power to influence, relationship building, a more participative style of leading and letting go of control, and most important of all, perhaps, the ability to build trust [4].

If in the future virtual work is going to increase, this seem to be the skills needed to achieve success, so acquiring, training and teaching them, as well as getting a better understanding of what they consist off at a more fundamental level becomes vital.

#### 5. Conclusions

It is difficult to believe that the trend towards an increase in the number of virtual teams and VOs will invert itself, therefore understanding their characteristics, and analyzing which approaches work and which don't becomes very important. Being able to extract the best practices that successful leaders use in order to achieve their

objectives and to replicate them seems of paramount importance, because if virtual work is in its infancy in Romania today, it is just a matter of time until this will change.

The purpose of this paper is to spark interest in this field of research, and is the bases for further, more in-depth analysis, of the organizational models and leadership and management styles that can yield the best results in this environment.

## 6. References

- [1] Byrne, J., "The virtual corporation", *Business Week*, 1993, pp. 36-41
- [2] Fulk, J., DeSanctis, G., "Electronic communication and changing organizational forms", *Organization Science*, Vol. 6 No. 4, 1995, pp. 1-13
- [3] Hunsaker, P. L., Hunsaker, J. S., "Virtual teams: a leader's guide", *Team Performance Management: An International Journal*, Vol. 14 Iss 1/2, 2008, pp. 86 – 101
- [4] Jarvenpea, S., Leidner, D., "Communication and Trust in Virtual Teams", *Journal of Computer Mediated Communication*, 1998
- [5] Jarvenpea, S., Leidner, D., "Trust and the Virtual Organization", *Harvard Business Review*, May-June, 1995, p.40-50.
- [6] Lipnack, J., Stamps J., "*Virtual Teams: Reaching across space, time and organizations with technology*", John Wiley and Sons, New York, 1997
- [7] Malhotra, A., Majchrzak, A., Rosen. B., "Leading virtual teams", *Academy of Management Perspective*, Vol. 21 No. 1, 2007, pp. 60-70
- [8] Mowshowitz, A., "Virtual organization", *Communications of the ACM*, Vol. 40 No. 9, 1997, pp. 30-7
- [9] Shekhar, S., "Understanding the virtuality of virtual organizations", *Leadership & Organization Development Journal*, Vol. 27 Iss 6, 2006, pp. 465 – 483
- [10] Smith, A., Sinclair, A., "*What makes an excellent virtual manager*", Roffey Park Institute, West Sussex, 2003
- [11] Wardell, C., "The art of managing virtual teams: Eight Key Lessons", *Harvard Management Update*, October, 1998

# The Role of Process Interactions Management in Ensuring Business Sustainability

Ruxandra Maria Mateescu

*The Bucharest University of Economic Studies, Romania*  
[ruxandra.mateescu@gmail.com](mailto:ruxandra.mateescu@gmail.com)

Steffen Lange

*The Bucharest University of Economic Studies, Romania*  
[steffen.s.lange@gmail.com](mailto:steffen.s.lange@gmail.com)

Heinemann Bastian

*The Bucharest University of Economic Studies, Romania*  
[bastian.heinemann@web.de](mailto:bastian.heinemann@web.de)

## Abstract

Starting 2008 the economic climate has set new rules for managing business and has created the necessity of finding means to balance key performance indicators. The most important risks for business survivability are at operational management level. More and more organizations use process approach as main management strategy during the financial crisis. The purpose of this research is to highlight the fundamental role of managing and controlling process interactions in process-based quality management systems. The study is based on interviews with managers on the subject of process approach based on the PDCA (plan-do-check-act or plan-do-check-adjust) management method. The results of the research show the importance of controlling and continuously improving processes in the current business environment.

**Key words:** process approach, process interactions, process-based quality management system, business sustainability, economic crisis

**J.E.L. classification:** L2

## 1. Introduction

At the core of any organizational objectives are a number of business processes that determine the success rate of the company's goals.

Organizations oriented on business processes are organizations with a solid value

chain (figure 1) as framework for thinking strategically about the activities involved in any business [1], assessing their value and determining the potential competitive advantage. These organizations understand that today measuring KPIs (key performance indicators) is no longer sufficient for survival. Thus, these organizations adopt a new strategy for improving organizational performance by focusing on process management.

Figure 1. Value chain

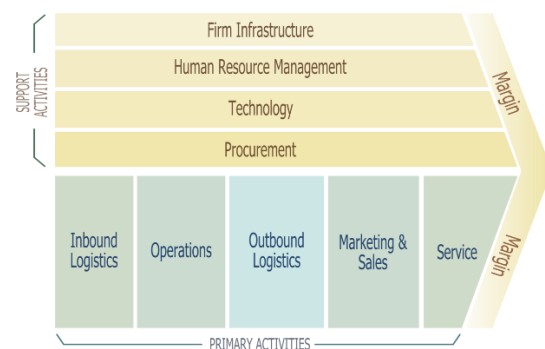

Source: Porter M.

## 2. Theoretical considerations

The process is a set of interrelated or interacting activities that transform inputs into outputs. Processes are planned and carried out in work flows under controlled conditions in order to add value. During the last decades, intensive research has been conducted with respect to the design, implementation, execution, and monitoring of business processes. [2] Business process management sets out to increase the effectiveness and efficiency of an

organization; it is a significant contributor to overall organizational performance and competitiveness and it has become an increasingly important enabling factor of organizational innovation and transformation. [3]

According to ISO9001:2015 [4][5], when managers use a process approach, it means that they manage and control the processes that make up their organizations, the interactions between these processes, and the inputs and outputs that tie these processes together. It also means that they manage these process interactions as a system.

Deming's PDCA (plan-do-check-act) management method [6] shows that value-adding results can only be achieved when a process includes a feedback loop that allows:

- Process planning;
- Monitoring, measurement, analysis and evaluation of the process;
- Continuous improvement of the process.

According to Juran J.M. [7], the feedback loop (figure 2) includes a sensor that provides data and information derived from the monitoring and measurement processes; the umpire compares the company's objectives with this data. In case differences are found, the actuator acts as a corrective agent by making the necessary corrections so that data and information resulting from the monitoring and measuring processes do not differ from the objectives. The feedback loop process is universal, a healthy process can only work in this configuration. Regarding workflows and best practices across the organization, the universal feedback loop can be found in many of the management tools, software platforms and databases and is used successfully by organizations.

Feedback solves one of the main problems related to organizational processes, specifically controlling the interaction process; in other words, feedback can eliminate the leading cause that determines high risks with impact on the companies' finances.

Designing a process feedback loop requires answering to the following questions:

- Which are the main KPIs?
- Who compares the KPIs with the standard or desired parameters/

indicators/ outcomes?

- Who performs the diagnosis?
- Who uses the information and acts?

Figure 2. The feedback loop

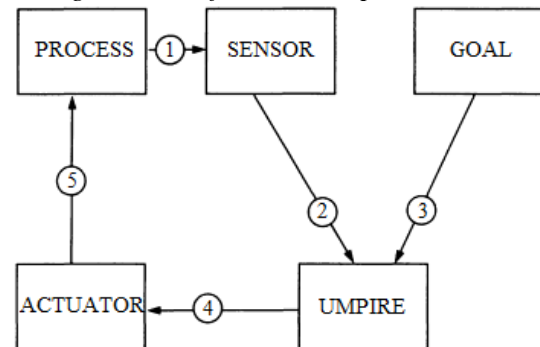

Source: Juran, J.M.

The answer to these questions must be prepared within the planning process. The PDCA methodology can be implemented only if the requirements related to the process approach are applied and their application is efficient. Compliance and effectiveness of process inputs and outputs are ensured by controlling the interaction between processes.

Within a company there are work flows from one management level to another - filtered, grouped and analyzed at each level, but also horizontal flows within each working process and between departments. Therefore, it is useful to determine the process interactions at hierarchical management levels and on the chain/interconnection of processes.

Hierarchical interactions (figure 3) are interactions between the process and the integrated quality management system.

Figure 3. Hierarchical interactions

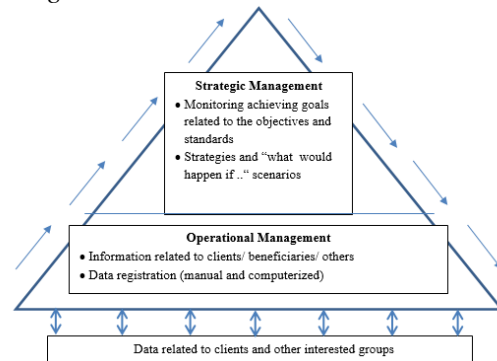

Source: authors

These interactions are established in order to achieve strategic and tactical objectives

and are controlled by the feedback system established across the organization, specifically reporting from operational management level to strategic management level. The process manager implements strategies at operational level, monitors and reports process performance and added value to the organization.

Chain process interactions (figure 4) are managed and provide added value horizontally on the organizational structure, i.e. at the junctions between two or more processes within the chain of operations. The process manager must secure and manage interactions with other processes. Therefore, risk management will be part of the managers' responsibilities [8]. Also, throughout the managers must provide efficient feedback to the other process managers.

Figure 4. Chain process interactions

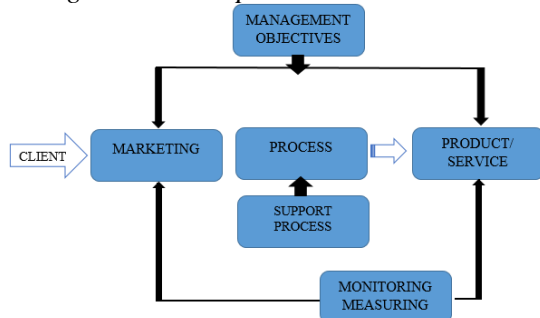

Source: authors

Feedback can related to all 4 steps of the PDCA method:

- Planning (P): the process manager receives planning data from other departments that should be included in the manager's planning activity;
- Doing (D): the process is executed (for example a product is made);
- Monitoring, measuring, analyzing and evaluating (C): the process manager receives information related to the quality of the products or KPIs and should take these results into consideration;
- Decisions or actions (A) taken as a result of the analysis and evaluation of the downstream processes that may lead to the need to improve the process. In this way, the new level of performance can become a source of improvement for the downstream processes.

When strategically using process approach managers should identify and analyze risks at each process junction. Process managers can discover significant risks threatening the very existence of the company's success. [9][10]

### 3. Research objective and methodology

The study aims at determining the role of managing and controlling process interactions in the current business climate. Process interaction management is studied regarding impact on the organization's performance, related risks and the strategic importance in ensuring business sustainability.

In order to determine the importance of managing these process junctions, in 2015 the authors carried out interviews with 3 chief executive officers and 18 process managers from the FMCG (fast moving commercial goods) and construction industries. The interviews lasted 25 to 35 minutes and included 4 main questions, as well as discussions around the responses of the interviewees.

### 4. Results

The research's results regard the managers' responses during the interview and the related discussions around 4 main questions:

Question 1 (figure 5): Which is the impact of poor process interaction management on the company's objectives?

Figure 5. Impact of poor process interaction management

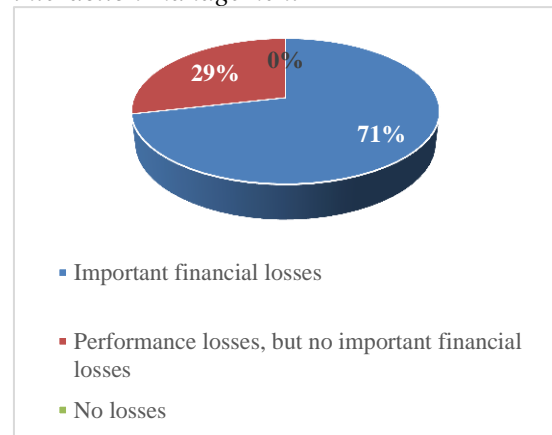

Source: authors

Results - 71% of the managers mentions that if not managed correctly, processes interactions could lead to important financial losses, therefore having a great impact on the company's sustainability. 29% of the managers are confident that business performance is affected with no important impact on the company's finances.

Question 2 (figure 6): Why should process interactions be controlled and managed?

Results – 67% of the managers respond that processes interactions are main source of high risks. Additionally, also events that may lead to the materialization of risks occur usually at process interactions level (interfaces). Risks are perceived as tolerable by 28% of the managers and not important by 5%.

Figure 6. Type of risks at process interactions level

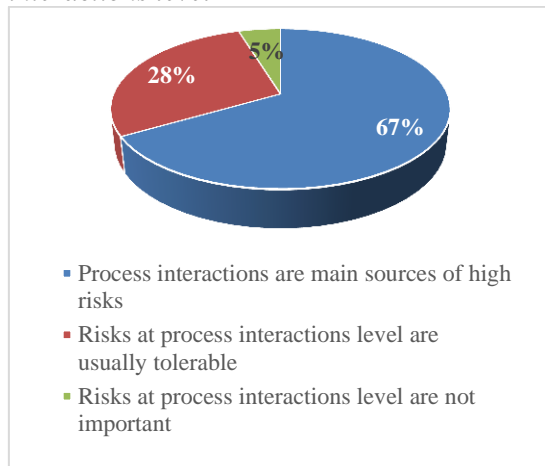

Source: authors

Question 3 (figure 7): Where are the highest risks when it comes to process interactions?

Figure 7. Main risks at process interactions

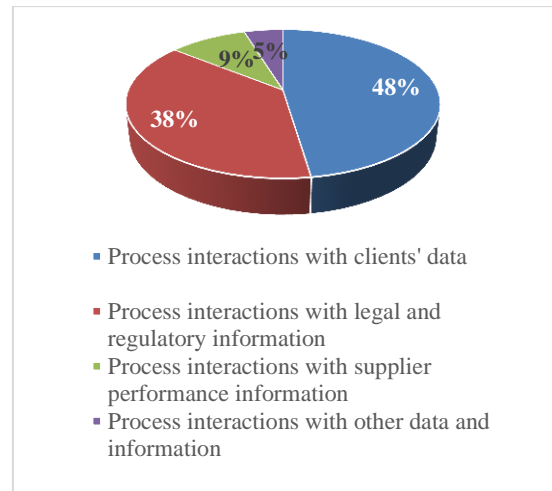

Source: authors

Results – According to 48% of the interviewees highest risks are determined at interactions for certain processes that ensure availability of data related to customers, specifically clients' requirements. Legal and regulatory information is considered as highest risk for 38% of the managers. Only 9% answer that supplier performance information is the highest risk and 5% identify other data and information as high risks at process interactions level.

Question 4 (figure 8): Do you consider process interactions management as value-adding?

Figure 8. The role of process interactions management

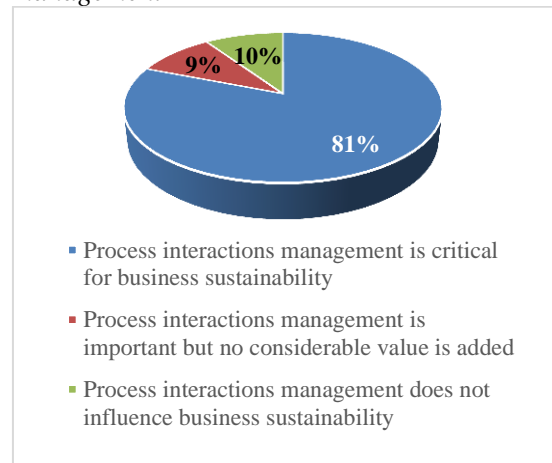

Source: authors

Results – The majority of the managers answer that process interaction management is of high importance for business sustainability. Less than 10% of the interviewees consider that no considerable



value is added or that process interactions management does not influence business sustainability; this is mainly the case because these managers consider that processes interactions are not value-adding.

## 5. Conclusions

The role of process interactions management can be determined by identifying and analyzing risks at each junction between two or more processes both hierarchically (vertically) and at chain processes level (horizontally). Managers consider that critical data and information can be located at the interface between processes, therefore risks increase depending on the value of the information managed at the process junction. While process interactions add no value to the business, it is processes that bring the value to the business. This should not affect the perception regarding the role of process interactions; dysfunctional interactions between processes can have an important negative impact on the company's finances, main causes being loss of clients' data and legal information.

This paper could be a starting point for further research on process-based quality management systems and their role in business sustainability and even company survival during the economic crisis.

## 6. References

- [1] Porter, Michael E. (1985) *Competitive Advantage: Creating and Sustaining Superior Performance*, New York: Simon and Schuster [Retrieved 9 September 2013].
- [2] Becker J., Rosemann M., Röglinger M., zur Muehlen M. (2012) „Business Process Management: An introduction to the special focus issue”, *Business & Information Systems Engineering*, Volume 4, Issue 5, pp 227-228.
- [3] Brocke J., Mathiassen L., Rosemann M. (2014) „Business Process Management”, *Business & Information Systems Engineering*, Volume 6, Issue 4, pp 189-189
- [4] ISO9001:2015 *ISO's Process Approach*, [Online], Available: <http://www.praxiom.com/process-approach.htm> [14 Nov. 2015].
- [5] Popa F. (2015), “ISO9001:2015 Punct si de capat (11)”, *Calitatea, acces la succes*, Vol. 16, Nr. 144.
- [6] Deming, W. Edwards (1986) *Out of the Crisis*, MIT Center for Advanced Engineering Study.
- [7] Juran J.M. (1992) *Juran on Quality by Design: The New Steps for Planning Quality Into Goods and Services*, New York: The Free Press, p. 380.
- [8] Mateescu R., Olaru M., Lange S., Rauch M. (2015) *Study on Supplier Invoice Risk Management in a Global Supply Chain*, IBIMA 2015 Conference Proceedings, Spain.
- [9] Miller, K.D. (1992) „A framework for integrated risk management in international business”, *Journal of International Business Studies*, Vol. 23 No. 2.
- [10] Brustbauer, J. (2014), „Enterprise risk management in SMEs: Towards a structural model”, *International Small Business Journal*

# Managing Online Brand Identity: the Case of Two Pure Players

Angela-Eliza Micu

*Ovidius University of Constanta, Romania*

[angelaelizamicu@yahoo.com](mailto:angelaelizamicu@yahoo.com)

Alexandru Capatina

*Dunarea de Jos University of Galati, Romania*

[alexandru.capatina@ugal.ro](mailto:alexandru.capatina@ugal.ro)

## Abstract

*This paper aims at emphasizing the most important online branding tools that two relevant pure players (Amazon and eMAG) use in order to promote themselves efficiently: SEO (search engine marketing), email marketing, social media, mobile marketing and affiliate marketing. Both companies aim at increasing customer traffic to their websites, create awareness of their products and services, promote repeat purchases, strengthen and broaden their brand name. They focus on continuously improving the customer experience, which creates word-of-mouth promotion that leads to acquiring new customers and may also encourage repeat customer visits.*

**Keywords:** brand, internet, email, costumers, market strategy.

**J.E.L. classification:** M41, M42, K31

## 1. Introduction

The internet has a stunning speed of development. In time, it provided individuals with the possibility of using new communication means, new collaboration and coordination resources between consumers, marketers and business people. It is at the core of huge economical and social changes, having the highest impact, because it is resourceful, dynamic, global, flexible and also cheap, if one is to make a comparison with the other mass communication means. Online branding provides instruments used to increase the company's conversion rate through online advertising, email campaigns, with a company's way of ranking highly in the search engines, through keywords number,

main keywords, link building or sites linked to Amazon.com or eMag.ro and with the importance assigned with social media campaigns.

## 2. Theoretical background

Although e-commerce "developed as a form of commerce without outlets, it represents both a form of merchandise circulation, and the group of activities and relations organized by units involved in the selling of products or services to intermediary or final consumers"[8].

Specialists define e-commerce as being "the use of electronic equipment with the purpose of making commerce activities, selling of goods or services taking place online or offline"[1].

"Through electronic means, companies can realize financial transactions, can establish a full circuit – distribution, selling or delivery of merchandise and services, in any quantity, both to individuals or legal entities" (Academica Science Journal)

According to Philip Kotler, the Internet isn't just a sales channel or an advertising mean. It is a company's basic instrument of changing the way it conducts its activity, takes orders from its clients and it gives them value".

The internet became more and more accessible to individuals from all over the world, so they started using it as a means of personal information, for sending private messages, or for shopping purposes. Whether they use the internet over PCs, smartphones or tablets, each individual expects to find as much useful information as possible about the desired products or services, choosing the Interned over the brick-and-mortar store. It is absolutely necessary for a company to describe itself and its products as detailed as

possible. Of course, it has to show transparency in all undertaken activities.

Many companies choose to develop a section on their website in which they offer information like the company's mission, values, stores map, order information, delivery, guarantees and, of course information about the products or services offered. Customers appreciate having a 24/7 access to a big amount of information regarding a company's products. In most of cases, companies choose to offer a catalogue to present their products or possible offers. It is very important for those catalogues to contain useful descriptions. For example, if an individual searches on a website a smartphone, he would like to know as many technical details as possible about it, not a 2 lines summary. Of course, in this way a company can attract new customers. If the actual customers are pleased with the services, they will help a company by bringing new ones. In order for a company to maintain its customer's interest, and to make them to buy something, it is necessary to make an advert to make the customers aware of a certain offer. For example, dePurtat.ro has a lot of banners with 4 of the top weeks' offer placed on different sites.

A good reason to have an online company is to make a long term relationship with the customers, through communication, customer education and loyalty. Whether a company is communicating with its clients through social media or a newsletter, the customer will feel important in the eyes of the company, so they will be motivated into making a new purchase. For example, Emag sends weekly attractive newsletters to those who have an account on their website. The internet is a customer orientation and education tool. If the products feature many advices, suggestions, ideas or techniques in order to maximize the customer benefit from using that product, we could consider that there is an interactive communication between the company and the client. All companies wish for more customers that will buy their products repeatedly, and, of course that will make referrals. In order to find out exactly what the customers want, their activity has to be monitored, meaning that the company has to assess exactly which are the most visited pages and to exploit them, and ignored those that are not being accessed. A good idea that

could help building a strong long term relationship is that of drawing a number of surveys that will allow the customers to give feedback. Of course, those ideas have to be taken into consideration, and the customers should know that their suggestions are appreciated.

Another strength of having an online company is that of cost reduction. Unlike traditional marketing instruments costs, the Internet provides with the possibility of engaging in cheaper deals. This thing happens basically by minimizing the company's costs with promotion, phone bills, wages and other typical costs, which leads automatically to decreased product prices[3].

Through its graphic interface, the Internet supports both the massive transmission and the "one to one" communication by text, and also the audio-visual. Advertising, personal sales, promoting activities, investigating markets must be made creatively to support and make your own promotional campaign more attractive. Among the most important characteristics of the Internet's influence on promoting, we can find: broadcasting a large amount of information regarding the promoted products, support in the purchasing decision, personalizing messages, offering purchasing impulses with a higher impact, facilitating the access of actual and potential clients, growing the interaction between the client and the firm, getting the company close to its clients, communicating in real time, using different promotions in order to stimulate purchasing, using electronic mail, telemarketing and conducting market research at lower prices. People, Process and Physical evidence in online brand management are about the importance of supplying services to clients, but they can also be applied to purchasing products[4].

#### **SEM and SEO**

"SEO is the process through which it is tried to obtain a better classification on a site in the search engines for relevant keywords/specific phrases for that site"[5]. It implies an initial optimization that consists in pages and site improving activities, followed by periodic SEO actions onsite and offsite (through link building or obtaining quality links that direct people to the site) and optimizing site conversion. Searching services have a great importance in selecting and filtering information in an optimal way.

Internet searching represents a channel through which clients reach companies or products of their interest.

Activities that promote a company online are a part of the category of Search Engines Marketing (SEM). SEM is considered a marketing technique through which the visitor gets what he looks for and through which there are attracted as many clients as possible. Also, actual clients are kept.

When we talk about SEM, we talk about supplying some useful and quality information, permanent update of the content, easy surfing, loading and quick feedback[6].

A search engine is a site whose content gathers information from millions of other pages. Among the most popular search engines we can find Bing, Google and Ask. In 2009, more than 67% of users used Google to find what they needed. This thing suggests the fact that any company should invest a little time to ensure that the company's site ranks high on all search engines. In the list resulted from the search engine we can find 2 types of results: organic or paid (ads). However, every search engine has a set of different evaluation criteria and depending on those a hierarchy of results occurred on the page is established (organic and paid). It is for granted that no company wishes to show up in a search engine on the 10th page, many users choosing to access the links on the first page, but you can't control from the beginning the location of the link on your site.

### 3. Online branding tools analysis in the case of two pure players: Amazon and Emag

First, we will emphasize seven principles related to SEO with high impact for online brand management strategies adopted by both Amazon and eMag.

**a. Create unique, accurate page titles, preferably for each page on your site.** Title tags are considered to be one of the most important on-page SEO elements which describe an online document. It is recommended for the page title to have between 60 and 80 characters, including the main keywords of the page.

Amazon uses 87 characters having a 40 % relevance in search engines, whilst Emag is using only 42, with a 83 % relevance. When

a company uses keywords in the title tag, search engines will highlight them in the search results if a user has performed a search including those keywords.

Bearing in mind that Google and other search engines display only 60-70 title characters, a company has to develop a title so that it doesn't diminish its effect. The best case is that of having a 35-40 characters tile, because a too long title is boring and hard to read for the customer. This is why Emag is doing better at optimization through page title.

#### **b. Use relevant keywords**

For a site to be optimized for search engines or before launching a paid campaign the best thing to do is make a list of keywords or terms that are likely to be used by potential customers when looking for information that you can deliver. In order to generate such a list, a very effective instrument would be Google Keyword tool, or even copying keywords from the competition.

In order for a company to improve its chance to rank as highly as possible in a search engine, it is important to include specific keywords in page content, title tag, page URL, Meta description, etc [7].

*Fig. 1 Top Keywords from Search Engines*

Keyword	Percent of Search Traffic
1. amazon	16.92%
2. amazon prime	0.42%
3. amazon.com	0.31%
4. kindle	0.21%
5. amazon.in	0.21%
Keyword	Percent of Search Traffic
1. emag	17.15%
2. allview	1.02%
3. emag telefoane	0.76%
4. emag.ro	0.72%
5. accesorii auto	0.42%

Source: alexatrank.com

Preferably, it is better to use 2 or 3 words expression that contain the needed keywords.

**c. Use well written, relevant content that includes words and expressions**

**related to the search.** You can also rewrite your content and code your pages so that they're optimized for search engines.

The product description can be searched on Google, so using keywords relevant to

your product, by using the same keywords as within the product title and subtitle will keep it reading naturally for your potential customers.

*Fig. 2 Example of relevant content including keywords*



Source: Amazon.com

*Fig. 3 Example of relevant content including keywords*

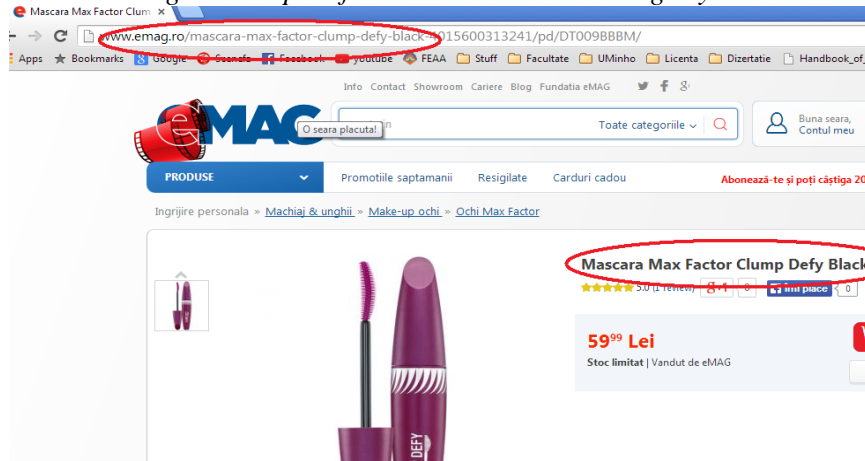

Source: emag.ro

What is very important to mention is the fact that both sites have very good description sections that could please anyone. Of course, in those descriptions are included keywords with a density ranging from 2-8%. For example, the highest density of amazon's keywords has the "amazon" keyword, with 4 percent, and the lowest is of 0.17, for "digital cameras". In Emag's case, the highest density is of 2.91 % for the word "basket".

**d. Use a website that loads quickly.** The load time of an individual page is how long it takes for the structure of the page to be loaded. This time doesn't include the time to load all images and style sheets, for example. According to Alexa traffic rank, both sites load pretty low. Amazon.com loads in 1.857

seconds, whilst Emag.ro loads in 2.851 seconds.

**e. Use both images and content.** Amazon's web page contains at least 152 distinct images to be downloaded and does not contain any unreachable images. Emag's web page contains 143 images.

**f. Use backlinks from respected websites.** Search engines reward you when sites link to yours. The more sites mention your site using a link, the more valuable it is. The higher the "page rank" of the sites that link to yours, the more they help raise your own rankings.

Fig. 4 Example of sites linking to Amazon  
What sites link to amazon.com?

Total Sites Linking In		1,091,958
Site	Page	
1. youtube.com	apiblog.youtube.com/2008_12_01_archive...	
2. yahoo.com	2010.yearinreview.yahoo.com/2010/us_in...	
3. baidu.com	apistore.baidu.com/astore/serviceinfo/...	
4. ebay.com	community.ebay.com/t5/Archive-PayPal/W...	
5. wikipedia.org	af.wikipedia.org/wiki/Spesiaal:Boekbro...	

Source: alexatrank.com

Fig. 5 Example of sites linking to amazon

What sites link to emag.ro?

Total Sites Linking In		2,047
Site	Page	
1. dailymotion.com	dailymotion.com/video/x19t2z_blue_stac...	
2. stackoverflow.com	stackoverflow.com/questions/11966187/p...	
3. themeforest.net	themeforest.net/forums/thread/can-+in...	
4. secureserver.net	ip-173-201-142-193.ip.secureserver.net...	
5. cnet.com	cnet.com/forums/discussions/conve-rtbl...	

Source: alexatrank.com

**g. Implement additional internet campaigns.** Generating traffic can also be achieved through social media, online advertising and online PR. Moreover, having a blog on the site is also useful, the same as distributing some easy to find press releases on the internet.

The importance that social media has raised by a lot lately. This means that companies had to optimize their websites for social media also.

Facebook is not the only social network that ranks highly. There is also Twitter, Youtube, LinkedIn, etc. What does this mean? Normally, it means that companies feel the need to optimize their company's messages exposure for the daily information flow that a

customer receives every day. The main effect of this strategy is that of increasing website traffic, building brand awareness, or increasing customer loyalty. All of this could be done by a company through sending online messages with current deals, content or videos publishing and online product presentations.

Fig. 6 Amazon Facebook stats



Source: SocialBakers.com

Fig 2.15 Amazon Youtube page

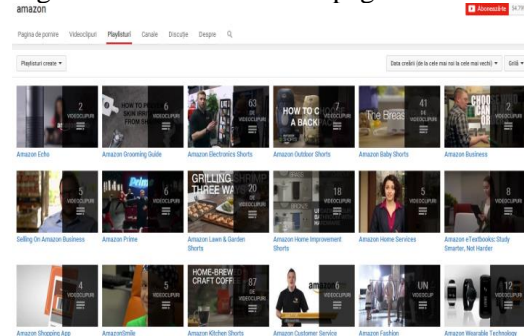

Source: Youtube.com

Fig 7 eMAG's fans on Facebook

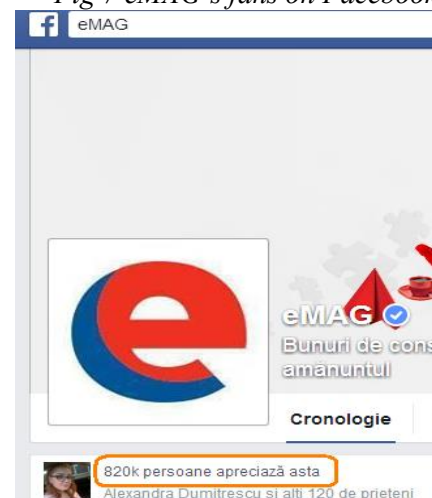

Source: Facebook.com

Fig. 2.17 eMAG's Youtube page

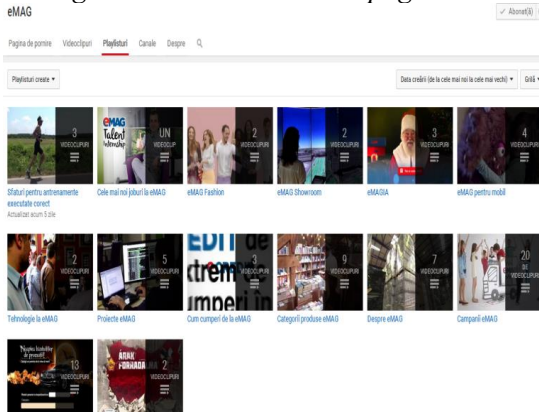

Source: Youtube.com/emag

Fig. 8 Youtube video on Facebook.com



Source : Facebook.com

It is considered that a good social media campaign is represented by video content, because it gives a business a good customer reach and interaction. Above are some examples of how both Amazon and Emag are using social media. For example, Amazon has 437 videos on Youtube, and Emag 230. As for their content, usually it is represented by product commercials, new products available, holiday offers, etc. both companies engage in this type of marketing tool also because it is easier for customers to give feedback and because it's effective for generating traffic to the websites. Another way of using social media is of having a company's blog. eMAG is using its blog to present contests, news about technology, information about the company, internships the company organizes, and about its showrooms.

Fig. 9 eMAG's Blog



Source : Blog.emag.ro

Through email marketing, any marketer can communicate at small costs with the customers in an immediate and relevant way, generate leads, and build customer awareness and loyalty.

In the case of Amazon.com, it is very important to show to its customers that it treats them individually. In order for the customer to see that, amazon uses few tricks:

- a) **Personalizes the emails.**

Fig. 10 Amazon's example of personalization



Source: Amazon.com

Amazon tracks each customer's activity in order to create a unique email that contains his name recommendation (based on previous purchased products), or news regarding new products that the customer would like to buy. To Amazon, email marketing is not just another marketing tool. Understanding each customer and listening to his complaints, more than 35% of all products sales come from recommendation via email. Being a smaller, national company, eMAG is also tracking its customer activity, but there are not listed the sales made through this mean.

A thing that customers appreciate at eMAG is the fact that they're response to complaints or questions regarding a certain product is very quickly.

b) **Email is an extension of your store.** Amazon's emails are very much alike the site itself. This leads to familiarity, which builds trust. Also, Amazon doesn't always offer discounts. No one discounts everything in a store, after all. It is also Emag's case.

c) **Tracking everything customers are doing on a website, it is what makes that company master the data.** In this way, it will be easier to come closer to your clients, and make them feel important for you. Amazon leads in the field of relevancy. The targeting is being very effective, so, when they send an offer via email, the email engine sends the products that are relevant to the customer.

Fig. 11 Example of how Amazon leads in relevancy



Source: Amazon email

Tracking a customer activity leads, in the case of eMAG, to giving different card gifts to loyal customers.

Fig. 12 Example of gift offered by eMAG



Source: eMAG email

d) Amazon's emails are very specific and direct. For example, if you bought a book, after a while, Amazon sends an email that reminds you to review that book. Another example of a simple email is the one that has a single offer that can be accessed through a single button. Sending a reminder email for review is also a practice applied by Emag.

### 3. Conclusions

Digital marketing have definitely changed the way companies reach their audiences. Every market strategy aims to increase sales and obtain competitive, cumulative and sustainable advantages, as well as to make a long term relationship with the customers, through communication, customer education and loyalty.

In order for a company to develop its business in the online environment, it has to



be aware of the fact that the website represents the most important and powerful instrument which launches the business in terms of sales and visibility in the online environment. Developing a properly website plays an important role for a company to consolidate its brand, generate competitive advantage, support customers and it helps to offer as detailed information as possible about the products/services offered in a convincing manner. Also, it generates publicity, processes orders and offers different promotions for holidays or to loyal clients. Moreover, it can easily communicate with clients, distribution channels, partners, investors and the persons that show interest towards being hired.

Among the most important characteristics of the Internet's influence on promoting both companies, we can find: broadcasting a large amount of information regarding the promoted products, support in the purchasing decision, personalized messages, offering purchasing impulses with a higher impact, facilitating the access of actual and potential clients, growing the interaction between the client and the firm, getting the company close to its clients, communicating in real time, using different promotions in order to stimulate purchasing, and using electronic mail.

#### 4. References

- [1]. Colecchia, A., Defining and measuring ecommerce, available online at <http://www.oecd.org/internet/ieconomy/1893506.pdf>, accessed at 20.03.2015
- [2]. Moderandi Inc., The Strategic Marketing Process, 2<sup>nd</sup> edition, 2013, Ebook available at <http://www.marketingmo.com/wp-content/uploads/2013/12/The-Strategic-Marketing-Process-eBook.pdf>, accessed at 02.04.2015
- [3]. Schwede, M., The structure of the e-marketing mix, 2006, available online at [https://familieschwede.files.wordpress.com/2006/12/e-marketing\\_mix\\_schwede.pdf](https://familieschwede.files.wordpress.com/2006/12/e-marketing_mix_schwede.pdf), accessed at 14.04.2015
- [4]. Saylor Foundation, eMarketing - The Essential Guide to Online Marketing, 2010, available at <http://www.saylor.org/books/>, accessed at 4.05.2015
- [5]. Shenton, J., Marketing on the internet, 2000, available online at [http://www.globalmillenniamarketing.com/reports/internet\\_marketing.PDF](http://www.globalmillenniamarketing.com/reports/internet_marketing.PDF), accessed at 12.04.2015
- [6]. Google Search Engine Optimization Starter Guide, available online at <http://static.googleusercontent.com/media/www.google.com/ro//webmasters/docs/search-engine-optimization-starter-guide.pdf>, accessed at 5.05.2015
- [7]. Srinivasan Mr. R., Jollyvinisheeba, J., Essentials and Strategies of E-Marketing, International Journal of scientific research and management, p. 251-255
- [8]. Simon O, Szasz F. – E-commerce vs. traditional commerce, *Academica Science Journal*, vol. 6, art. no. 1, 2014

## Few Aspects Concerning the Marketing Particularities in Healthcare Services

Silvia Muhcina

*Faculty of Economic Science, Ovidius University of Constanta*

[muhcina@gmail.com](mailto:muhcina@gmail.com)

Veronica Popovici

*Faculty of Economic Science, Ovidius University of Constanta*

[verovnp@yahoo.com](mailto:verovnp@yahoo.com)

### Abstract

*Approaching healthcare services from a marketing point of view is a very complex and complicated issue. On one hand, the Health Ministry has the strategic role of writing the health policy of a country, but on the other hand, certain particular interests can appear in the case of pharmacies, hospitals, clinics or individual doctors' offices etc., interests which might not always correspond to the central policies. Each one of these actors formulates its own marketing policy, creates and supplies specific products (medical investigations, treatments, cures etc.), establishes prices for these products, distributes them through marketing channels and communicates with stakeholders about these products and themselves.*

*The aim of this paper is to present a few aspects of marketing approach in the system of healthcare services.*

**Key words:** marketing, healthcare, services

**J.E.L. Classification:** M31

### 1. Introduction

Acting in a very turbulent environment, confronted with delicate problems generated by economic crises, strong competition or by the specific financing policy, the medical and pharmaceutical organizations must define an economic and marketing policy, in such a way that it allows them to achieve the aimed goals, to satisfy the consumers' needs, to survive or to lead on the market, to build or to maintain a strong image.

So, a strong correlation must be realized between the general, economic and marketing policies, and furthermore, between

the marketing objectives and strategy, the market target, consumers' needs and the marketing mix of the participants at health services' chain.

### 2. Health Services Marketing – Conceptual Elements

The services sector has a significant role in any economy, because, among others, it creates add value, it assures jobs and it improves the quality of life. Considering the marketing specialist's point of view, a service is any activity or advantage that is offered by one party to another, and which has, in essence, an intangible character, and does not result in the transfer of the ownership propriety of anything [1]. In the marketing literature, the healthcare services are defined as the utility obtained by the consumer as a result of some inter-conditioned activities which are based on a supplier-client relationship, and which are materialized in a physical, psychic and social welfare; in the same opinion, they are classified based on several criteria, such as: the level of healthcare (primary, secondary or tertiary assistance), the degree of healthcare services' difficulty (routine services, urgent services or chronic), the amount of time spent by the patient in the hospital, the compulsory nature of the service, the type of consumer (individual or collective), the nature of finances [2]. The marketing specialists consider that there are some special features that generally characterize the services, such as: intangibility, inseparability from supplier, variability, perishability, the absence of ownership [3]. The healthcare services are also characterized by the same features mentioned earlier:

- The healthcare services are intangible,

because the results of these services are not tangible. Even though the suppliers try to materialize these services through procedures, people, equipment, buildings etc., the results of the medical consultations, treatments, cures, medical investigations or other methods are difficult to visualize (patients' satisfaction, anxiety or fear, the recovery process etc.).

- The medical services are supplied in a strong dependence between supplier and consumer. There is a strong relation between every patient and every doctor or nurse, and even though there are some cases where the patient cannot cooperate (is in coma, is immobilized, cannot talk etc.), the medical care depends on the people involved.
- The medical service is different from one case to another and it can never be repeated in the same manner from one consultation to another, from one treatment to another, even though it involves the same patient, doctor or nurse.
- The medical services cannot be stocked and supplied for future use. For marketers it is difficult to find solutions to balance the demand with the supply (for example, in case of an epidemic flu, a measure that is generally used is to initiate a vaccination campaign, in such a way as to prevent people's sickness and to minimize the patients' demand for consultations and medical treatments).

In the marketing services' approach, there are several activities that, grouped into certain partial processes, are the basis of the following concepts: external marketing, internal marketing and interactive marketing [4]. In a similar way, the content of healthcare services marketing incorporates three important components: external marketing, that refers to a strategic and tactical marketing assembly, presented to consumers as the organization supply (consultation, treatment, cure etc., that are offered as a promised product and are sustained by price, distribution and promotional policies, during the first encounter between supplier and patient); interactive marketing, that refers to the created and delivered healthcare services, through the concrete interaction between supplier and patient; internal marketing,

which refers to a specific manner of treating the organization's personnel (doctors, nurses, other personnel categories etc.), as if it were in a consumer's position.

The healthcare services market functions according to certain general and specific rules. The evolution of any market is generally influenced by several factors, such as: the category of needs, the level of product accessibility, the product lifecycle, the resources-needs ratio, the governmental economic policy, and the organizations' marketing policy [5]. Based on this approach, it can be said that the healthcare services market can be mostly influenced by the following factors:

- The category of needs: health services aim to satisfy present needs (physical or psychological integrity), thus the market is more or less rigid; moreover, depending on the category of diseases, treatments or interventions, it can be more or less broader (for example, a dental urgency is offered by few suppliers, but for dental treatments, patients can choose between several dentists and dental cabinets); on the other hand, is very difficult to appreciate the level of the future health needs;
- The level of product accessibility: in the case of rare diseases, which could demand special, complex and rare treatments or equipment, the costs are very high and the accessibility is limited; on the other hand, for many health services or medication, the price doesn't reflect the real cost because is settled by other decisional factors;
- The product lifecycle is important even in this type of services activity; usually, medical consultations, treatments or investigations are based on specific procedures, but the buildings, the equipment, the medication, and even the personnel and patients have different lifetime cycles;
- The governmental economic policy is a factor with a very strong impact, because through specific tools (taxes, subventions, prevention programs etc.), it can contribute to the increase or decrease of the healthcare services market;
- The medical organizations' marketing policies, mostly in the case of private suppliers, which offer similar services.

The demand for healthcare services is based on the health services' needs, and can be approached from an individual perspective or a collective perspective (groups, local communities, national collectivities etc., for example, in cases of epidemics). The healthcare services demand can be influenced by different interests and reasons: by patients' interests (to be investigated and treated by the best specialists, on reasonable price and at the nearest location), by health suppliers' reasons (family doctors, specialists, hospitals, medical laboratories etc., that are interested in supplying medical consultations, investigations or treatments for a reasonable number of patients, having reasonable time and financial costs), or local or national institutional or authorities' reasons (schools, enterprises, town halls, governments etc., that can be interested, for example, in preventing an epidemic).

The supply expresses the organization's capacity (network, resources, management etc.) to satisfy the specific demand of health services, in certain conditions of structure, quantity and quality. Similar to other services, the supply can be [6]: theoretical supply (incomplete and summarily expressed by elements that assure the necessary condition to execute the services, in a theoretical manner; the patient goes to a doctor based not only on the trust and confidence in the doctor's knowledge, care and responsibility, but also in the medical environmental conditions -equipment, hygiene etc.), potential supply (promised and warranted, including all the elements which materialize the product -atmosphere, personnel, prices etc.), effective supply (which expresses the promised products, in terms, conditions and shape which unleash the consumption -the effective medical consultation or intervention).

In Romania, the most important healthcare services' suppliers are the following [7]:

- Primary Health Assistance services, such as essential medical services suppliers (for example, family medicine doctors, emergency medicine, acute medical solicitations, chronic diseases monitoring or preventive medicine), extended medical services suppliers (for example, optional primary health assistance, such as taking care of patients at their

residence, planning and advising etc.), additional healthcare services suppliers (for example, complementary medicine);

- Specialized ambulatory medical services' suppliers such as: medical cabinets, diagnostic and treatment centers, hospital consultation services, and dental medicine;
- Hospital healthcare services suppliers, grouped by territorial area (local, regional or central area), the specific pathology (emergency medicine, general or specialized in certain diseases), the relation with education and research activity (clinic, institutes etc.), or other criteria;
- Emergency health services and sanitary transportation.

Each one of these suppliers has its own interest and must integrate its own policy in the assembly of healthcare services system policy, and must create an appropriate marketing policy so that it corresponds to the macro marketing healthcare activity.

### **3. Some Particularities of Marketing Mix in Healthcare Services**

Considered as a 'mixture' of the organization's four pillars (product, price, placement, and promotion) of the marketing activity [8], the concept of marketing-mix can be successfully applied in the healthcare services.

The product policy is the most important component of the marketing mix and is based on the concept of product, which, in marketing specialists' opinion, is structured on three levels: basic product (what consumers buy), effective product (defined by five features: quality, characteristics, style, brand name, package) and improved product (created through supplementary services and advantages that are offered to consumers) [9].

In services marketing, the product policy is based on the concepts of global product and unitary (partial) products [10]. Concordant with this opinion, the global product is the result of the interactions between its components and their final effect, and reflects the assembly of all activities that create utility for the consumer. These activities generate unitary products: basic, auxiliary, supplementary (peripheral) and

potential products. The global product is an assembly of tangible and intangible elements, communication about the product and its image [11].

In healthcare services, the basic product responds to the basic health needs (medical investigation or check, treatment, recovery, prevention, or any other health necessity of patients, collectivities or nations). The auxiliary product assures the minimum conditions to realize the basic services (environment, equipment, infrastructure for hospitalization, accommodation, treatment, medical analysis, etc.). The supplementary products give a plus of utility for basic products and can create differences between medical competitors (healthcare services for patients at their residence, analyses or other investigations at patients' residence, transportation etc.), even though those differences are very difficult to be appreciated in a clear manner. The potential product contributes to creating a high level of services personalization and to positioning the organization's image (are usually supplementary paid, involve high standards of comfort and quality and a highly qualified personnel etc.). The unitary products are materializing the services, and through physical facilities (environment, medical equipment and infrastructure) and people (personnel and patients), assure the services' supplying in an appropriate manner.

In the process of elaborating the product's strategy, there are some elements that have a major importance for suppliers, such as services quality, productivity and differentiation [12]. In the same way, these elements are important for health services as well: the healthcare services' quality is difficult to be appreciated (the patient or his relatives judge the quality of a medical act based on several elements, such as the patient's healing, the level of medical attention and care received from the doctor or the nurse etc.); the services' productivity is closely related to the waiting time for the medical check, investigation, treatment or intervention; the services' differentiation is mostly realized through quality and productivity and balancing marketing and operation (finding the balance between customer (market) orientation and product orientation, in other words increasing the patients' satisfaction versus high

standardization).

The appreciation of medical services' quality is very difficult to do, but there are some indicators which could serve to determine in what measure the quality of tangible elements can increase the quality of medical services. For example, the number of beds from hospitals, which in Romania is continuously decreasing. In 2010, 136.341 beds existed, and in 2013, 123.127. Moreover, according to the Health Ministry's strategy, for 2014, 2177 beds were planned to be reduced, and for 2015 and 2016, 1000 beds each year [13]. Another indicator can be the number of doctors for one thousand people, which, according to Romanian statistics, in 2014, was about 2,8 doctors for 1000 people (which is less than the European average, that is 3,3 doctors for 1000 people) [14].

The price policy has some particularities, mostly because the medical services are financed by many contributors. The participants at the healthcare system are the users/beneficiaries (individual patients, organizations etc.), the suppliers and the third party payer. The buyers of healthcare services are the state, the insurance houses, the individual healthcare services consumers, other organizations (firms, syndicates, schools etc.). Based on the system of funds collection, in Romania there are several types of healthcare services payment systems [15]: the private (voluntary) health insurance; the social health insurance (public insurance paid by individual people to an insurance society); the general tax system (through state tax collection and distribution system); the distinct tax collection for health insurance system (salary tax); other types of financing, such as direct financing, co-payment system etc. According to the information published in 2014 concerning the healthcare system, in the year of 2012, the total costs for the healthcare system was 32.6 thousand millions lei, of which 32 billion lei (98%) were ordinary expenses, and 574.5 million lei (1.8%) represent cost for capital. From the total costs, 80.3% (126.2 billion lei) were public expenses, and 19.75% (6.4 billion lei) were private expenses [16].

The price policy can be influenced by several internal and external factors, such as marketing objectives and strategy, costs, organizational considerations, market and

demand, competition or other external factors [17]. In public healthcare services, the most important factors are costs (financial, time and stress costs) and demand, because the Health Ministry realized the funds' allotment for hospitals, clinics, and primary health assistance etc., based on these factors. Generally, in public medical institution, the acquisition system for medical materials and instruments is realized through public tender, and the lower prices have a significant role and an important influence in the final price of services. The competition is very important especially in private medicine, where the prices are influenced not only by the infrastructural costs (buildings, equipment, laboratories etc.), variable costs (for example, related to treatment, intervention, medication, salaries etc.), but there are some factors difficult to measure (the doctor's prestige, the institution's fame, the quality of the management etc.). Usually, a low price for medical services raises questions regarding their quality, and this can influence the patients' choices.

The distribution policy has some particularities in healthcare services. The most important aspects are related to the healthcare unities' network (interactive marketing area) and to the distribution channel system (external marketing area).

The medical services suppliers have contracts with health insurance houses. The nodes of the healthcare network correspond to the medical services suppliers: family doctors' cabinets, medical clinics, treatment and recovery institutions, hospitals etc., and are set based on the demand's manifestation tendencies. The medical services' distribution can be realized through direct channels (for example, when the family doctor is consulting one of his patients) or indirect channels (short or long distribution), for example, when the doctor gives his patient a medical recommendation for a specialist check or the specialist gives a prescription to the patient's family doctor. The network can be more or less developed, based on the number of the supplying places, the medical services or the number of consumers. In some cases the services' supply is realized through one organization, in other cases several services are offered through a large network of unities' suppliers (for example, in Romania acts MedLife,

Regina Maria, Gral Medical etc.).

Sometimes, for economic reasons or to satisfy in better conditions a complex demand, the distribution of health services can be realized through partnerships between several medical services suppliers (family doctors, specialists in medicine science, medical laboratories and clinics etc.).

Generally, for certain chronic diseases, for minor interventions or to diagnose simple medical problems, the direct channel or the short indirect channel are the most used ways to distribute the medical services. When the problems become more complex, the diseases are stern and difficult to diagnose or treat, the channels are longer (for example, family doctor-specialist/clinic-hospital-family doctor). The distribution channels' control is realized mostly based on the volume of supplied medical services (based on the involved services' suppliers, the number and the value of services supplied and settled). This control is realized mostly by Health Ministry representatives, other local or central authorities and, in certain cases, the companies which pay to insure their personnel. The problem that is the most difficult to appreciate is the quality of distribution (the quality of the medical consultation, intervention, treatment, the doctor's attitude and care, the time spent by the patient to be consulted, the price of services etc.).

The marketing communication policy has an important role in health services area, although the juridical settlements are very restrictive. There are several aspects that can have a significant role in choosing and integrating the communication channels and tools: the particularities of patients (persons or collectives) and of health services' suppliers (doctors or organizations; private or public health services suppliers etc.). In internal marketing is essential to assure an appropriate personal communication towards and between the employees. In external marketing, the physical ambiance can communicate in a pleasant way and can increase the patients' trust in the suppliers' capacity to care and to cure the patients' diseases. For patients the attitude and the explications offered by the personnel from healthcare services (doctors, nurses, other categories of personnel) can contribute in a significant way to a good perception and a

favorable image of the services' quality level. The tools that can be successfully used to communicate in sanitary area are: the advertising, the sales promotion, the public relations, the marketing events, the brand, the sales force and the direct marketing. In an integrated marketing communication system it's necessary to include those tools and channels that are corresponding in a better way to the marketing communication's objectives and goals, to the target-market and to the budget that can be allocated. For example, in a public campaign initiated by the Health Ministry for an important health cause or problem (vaccination campaign, drugs consume prevention etc.), one can use advertising campaign on television and public relations' tools, for promoting new medicines, new equipment etc. to specialists, family doctors, hospitals, pharmacies etc., can be used the sales force's representatives or sales promotions (for example, the merchandising, nearby personal communication are very important tools used in pharmacies), for promoting the brand image of hospitals or laboratories one can use public relations, printed materials or marketing events etc.. Obviously, a strong favorable corporate or professional image can be obtained and maintained only by a responsive attitude, good professional knowledge, the talent and the passion of the healthcare services' personnel, compassion and good care for patients.

#### 4. Conclusions

The healthcare services sector is an important area of an economy because it assures the physical and psychic health of the people from a country or a region and, in the same time, it assures jobs and incomes for a significant part of active people. Approaching this sector based on marketing principles and tools allows obtaining a good correlation between individual and social health needs and the capacity of a health services system to satisfy these needs, and based on that, creating and implementing a healthy health policy of a country.

#### 5. References

[1] Kotler, Ph. etal, *Principiile marketingului*, Ed. Teora, București, 1998, p. 699

- [2] Rădulescu, V., *Marketingul serviciilor de sănătate*, Ed. Uranus, București, 2008, p. 17; 20-21
- [3] Kotler, Ph., *Managementul marketingului*, Ed. Teora, București, 1997, pp. 585-589
- [4] Gronroos, Ch., “A Service Quality Model and Its Marketing Implications”, *European Journal of Marketing*, 18, nr. 4 (1984), pp. 36-44; Kotler, Ph., *Managementul marketingului*, Ed. Teora, București, 1997, pp. 589-591; Olteanu, V., *Marketingul serviciilor. O abordare managerială*, Ed. Ecomar, București, 2005, p. 40
- [5] Balaure, V., etal, *Marketing*, Ed. Uranus, București, 2002, pp. 102-103
- [6] Olteanu, V., *Marketingul serviciilor. O abordare managerială*, Ed. Ecomar, București, 2005, pp. 101-103
- [7] Contractul-cadru de aplicare a Legii 95/2006 privind Reforma în domeniul sănătății; Rădulescu, V., *Marketingul serviciilor de sănătate*, Ed. Uranus, București, 2008, pp. 58-71
- [8] McCarthy, E.J., *Basic Marketing*, Irwin, Homewood, III, 1960, Balaure, V., *Marketing*, Ed. Uranus, București, 2002, p. 322
- [9] Kotler, Ph. etal., *Principiile Marketingului*, Ed. Teora, București, 1998, pp.653-654
- [10] Lejeune, M., “Un regard d'ensemble sur le marketing de services”, *Revue Francaise du Marketing*, nr. 121 – 1989, p. 24; Olteanu, V., *Marketingul serviciilor. O abordare managerială*, Ed. Ecomar, București, 2005, p. 168
- [11] Balaure, V. etal, *Marketing*, Ed. Uranus, București, 2002, p. 339
- [12] Kotler Ph., *Managementul marketingului*, Ed. Teora, București, 1997, pp. 592-602
- [13] \*\*\*Hotărâre privind aprobarea Planului național de paturi în perioada 2014-2016, în [http://www.ms.ro/documente/NF%20si%20HG%20Plan%20national%20de%20paturi\\_930\\_1848.pdf](http://www.ms.ro/documente/NF%20si%20HG%20Plan%20national%20de%20paturi_930_1848.pdf), accesed 14.08.2015
- [14] \*\*\*[http://www.insse.ro/cms/files/IDDT%20012/Date\\_IDDT/T5\\_5.Numarul%20de%20medici%20la%201000%20locuitori.htm](http://www.insse.ro/cms/files/IDDT%20012/Date_IDDT/T5_5.Numarul%20de%20medici%20la%201000%20locuitori.htm), accesed 14.08.2015; <http://www.observsanatate.ro/>, accesed 14.08.2015
- [15] Rădulescu, V., *Marketingul serviciilor de sănătate*, Ed. Uranus, București, 2008, pp. 74-77
- [16] Sistemul Conturilor de sanatate in Romania in anul 2012: <http://www.insse.ro/cms/content/alte-publicatii>, accesed 13.08.2015
- [17] Kotler, Ph. etal., *Principiile Marketingului*, Ed. Teora, București, 1998, pp. 734-749

## The dynamics of Organically Certified Operators in Romania Between 2012 and 2014

Adina Roxana Munteanu

The Bucharest University of Economic Studies

[munteanu.adina@gmail.com](mailto:munteanu.adina@gmail.com)

### Abstract

*The land area that is organically certified increased constantly in the last six years serves as proof that the organic agriculture system becomes more popular in Romania. This study aims to present a clear picture of the dynamics of the organically certified operators between 2012 and 2014. To the best knowledge of the author, this research is unique as it analyses in dynamic the evolution of the certified operators, their geographical distribution in the country and the market share of the certification bodies in the analyzed period, based on the data collected over a three year period from both certification bodies and the Romanian Ministry of Agriculture and Rural Development. The main results refer to the trends of migration of certified operators from one certification body to another and the number of operators that entered in the system of organic agriculture and of those that decided to exit.*

**Key words:** organic agriculture, organic operators, certification body, Romania

**J.E.L. classification:** Q19

### 1. Introduction

In the last years organic farming kept gaining popularity in Romania. However, the data concerning the value of the Romanian organic market is quite scarce, with estimates of the organic market in 2010 at less than 1% of the retail market (InfoMina, 2008; Cult Market Research, 2010). This level is lower compared with the market share registered in other European countries such as Denmark (7.2%) or Austria (6%) but closer to the level of France (2%) (Willer and Lernoud, 2013).

Before presenting more information on the trends of the organic market in Romania, we shall first explain some important aspects like what organic certification means, what are the benefits and constraints of organic certification and what institutions can provide the certification for farmers or processors or other entities such as traders, generally referred to as operators.

In simple words, organic farming is an agricultural system that produces crops while respecting the natural environment. Organic farming is based on a number of principles and practices designed to minimize the human impact on the environment, while ensuring the agricultural system operates as naturally as possible.

It can be argued that organic agriculture is good for the land, is good for the people and good for the economy. However, the mere application of the principles and practices although very beneficial for the land and for the people consuming the organic products, is not as relevant to the economy, except if the organic products are certified as organic by a third party certification body.

The organic certification refers to the issuing of a certificate of conformity by a certification body to prove that a specific operator is compliant with the organic standard under discussion, which is for Europe the EU legislation.

The certification process comes with both benefits and constraints for the organic operators. A major argument for organic certification is that it allows producers to access niche markets and obtain premium prices. However, premium prices are not always easy to obtain in the case of developing countries and smallholders. It is also relevant that the organic premium prices need to cover higher production costs (especially labour) and the certification and inspection costs (Dankers and Liu, 2003).



The cost of certification is probably the main constraint for those willing to obtain an organic certification. Referring specifically to Romania, the calculation of the certification fee by the certification bodies can be quite sophisticated and not transparent in many cases, making it difficult to assess which certification body is actually cheaper without actually doing all the paperwork required during the certification process. Most of the time the total fee is composed of a basic fee and a variable fee according to the area, the type of crop, the number and type of animals. The variable part of the fee differs according also to the price level with which the certification body operates.

According to the CERTCOST (2012) report on the costs of three organic certification systems project that took place in six European countries, the inspection fee is the most relevant monetary expenditure for organic operators with respect to the certification costs. Moreover, the same report states that the total costs of inspection and certification favour large commercial farms where the impact of the costs of certification is considerably smaller compared to a smallholding.

## **2. The evolution of the organic certification 2012-2014 in Romania**

Romania, as part of the European Union has subscribed to the objectives, principles and rules applicable to organic production as mentioned in the Community legislation regarding organic farming. The EU legislation was translated into national legislation so that the rules, along with definition of the production methods and the aspects of processing, labelling, trade, import, inspection and certification are aligned with all other EU member states.

In Romania, the control and certification of organic products is currently provided by private inspection and certification bodies. The control and certification are approved by the Ministry of Agriculture and Rural Development (MARD), as specified in the Order no. 181/2012 for the approval of rules on the organization of inspection and certification, approval and certification of inspection bodies and supervising control bodies.

MARD approves the inspection and certification bodies only if they are accredited in accordance with European standard EN ISO/IEC 17065: 2013, issued by an agency authorized for this purpose. The national accreditation body is RENAR, but other European accreditation bodies are accepted such as ACCREDIA, COFRAC, and DAKKS.

In 2015, in Romania there are 14 authorized inspection and certification bodies for the organic sector, compared to 14 during 2013-2014 and 12 in 2012. In 2015 the certification bodies are companies registered in Romania (9/14) and also subsidiaries of international companies (5/14). The oldest certification body that is authorised by the MARD in 2015 is Ecoinspect which is registered since 2002 in Cluj Napoca.

In the next paragraphs the researcher aims to present a clear picture of the dynamics of the organically certified operators between 2012 and 2014. To the best knowledge of the author, this research is unique as it analyses in dynamic the evolution of the certified operators, their geographical distribution and the market share of the certification bodies in the analysed period, based on the data collected over a three year period from both certification bodies and the Romanian MARD. The researcher specifically focuses on the geographical distribution of operators and the trends of migration of operators from one certification body to another and the trends of the operators existing and those entering in the organic agriculture system.

The analysis presented below is based on data which was collected during July 2012 and September 2015 referring to the organic certificates issued for the Romanian operators by certifications bodies authorised by the Romanian MARD. The source of data is the MARD website where since 2013 the list of organically certified operators and the actual copy of the organic certificate, as issued by the certification bodies, are published. Overall, for the period of 2012 - 2014 over 41.000 organic certification (as pdf files) were collected and analysed.

As a side note on the MARD website the data referring to 2014 are published in 2015. However, the certificates are periodically updated and for 2014 for example, there were two updates in the number of the 2014 certificates between March and August 2015

and not all certificates are uploaded at the moment of the writing of the article. However, in order to increase the reliability of the data, the certification information was triangulated with the information available from the certification bodies.

The data on the MARD website (MARD, 2015) regarding the organic agriculture figures creates an optimistic view, as the organically cultivated agricultural surface steadily increased since 2006 when there were more than 97,000 ha to over 300.000 ha in 2013.

In Romania, the overall increase of organic land is situated at 4.4% in 2013 compared to 2012, while according to Willer and Kilcher (2015, pg. 209) in EU the level is 3%. Moreover, it is relevant to point out that the total area of organic pasture and meadows has been increasing in Romania between 2006 and 2013 by more than three times, while the overall area reserved for organic pastures in Europe has been declining in 2013 compared to 2012 by 2% (Willer and Kilcher, 2015, pg. 210).

Looking at the dynamics of the organic operators their number follows an upward trend until 2012, when more than 15,500 organic operators were registered, followed by a slightly declining trend of 2% in 2013 compared to the previous year and respectively 7% in 2014 (see figure one).

Figure 1 The evolution of the no. of organic operators in Romania between 2006-2014;

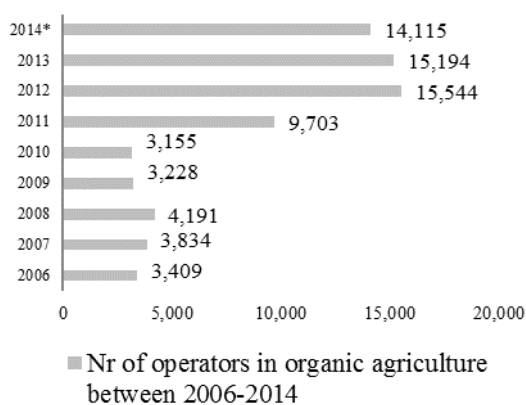

Source: MARD (2015, 2011) for 2006 -2013;  
own calculation for 2014;

It is significant to note that there is an increase of more than 300% in the number of organic operators in 2011 compared to 2010 which is reflected in a much less increase of

26% in the total area of organically cultivated land in the same period. Moreover, during the next one year period, between 2011 and 2012, the increase in the number of operators reached the level of 60% while the total area of organically cultivated land maintains the increase rhythm at 25%.

The above mentioned dynamics is partially due to the subsidies program initiated by the Government Decision (GD) 759/ 2010. This GD gave the organic operators the opportunity to receive yearly subsidies between 500-4.000 euros, in the context of an overall yearly budget of around 3.1 million euro, out of which 2.37 million were designated for vegetable production. In order to receive the subsidies, the farmer needed to enter in the organic agriculture system for at least five years and enter into a contract with an authorised certification body to get certified.

However, as the number of organically certified operators increases and the budget for subsidies is likely to remain largely unchanged, it is highly likely that the subsidies per operator will decrease and at that point, we could witness a decline in the number of organic operators as the five year period, in which the operator had to remain in the system ends.

Another explanation for the faster increase in the number of operators that the increase in land area, is the fact that many of the newly certified operators have certified very small areas of land. This explanation is supported by a study regarding group certification in which Munteanu (2014) analyses a sample of 4.989 of organic certificates, representing 33% of the valid organic certificates recognised by the MARD for the year of 2013. Out of these certificates, 741 had no land information of the land information was not relevant (apiculture, aquaculture, collection from the wild, traders, processors). For the 1929 certificates that contained information on the area of land certified as organic, 72% had less than 10 ha under the regime of organic agriculture.

In 2012, according to Willer and Kilcher (2015, pg. 39), Romania is the 25th country by surface of the organic agricultural land (including in-conversion areas) with the 288,226 ha. However, the country has much more potential, as there are 14.8 million hectares of agricultural land INS (2012, p.

89). Moreover, at the level of 2012 in Romania organic agriculture occupies only 2.1% of the agricultural land, and considering countries with more mature organic markets like Germany, Denmark or Spain where the surface of the organically cultivated land represents around 6.4% or Poland with 4.3% (Willer and Kilcher, 2015, pg. 43), we can anticipate further growth as the organic practices and principles are still at the beginning of their journey of implementation.

We shall now observe the distribution of the organic certificates by certification bodies in the three years of the analysed period, as depicted in the figure two. Clearly, the market leader during the entire investigated period in Romania is Ecocert (RO-ECO-007), followed at a significant distance by Ecoinspect (RO-ECO-008) and Ceres Happurg (RO-ECO-014).

The current market leader, Ecocert, a company registered since 2004 in Bucharest, is present in all 41 counties of Romania, while 67% of its issued certificates in 2014 are to operators in Alba, Cluj, Satu Mare, Caras Severin and Brasov Counties.

Figure 2 List of the distribution of the no. of certificates issued by certification body

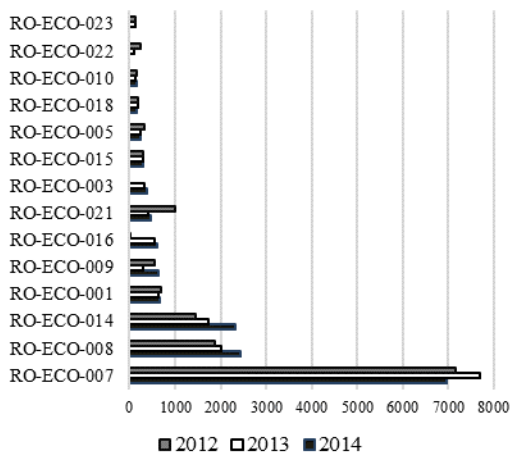

Source: Own calculations

The second most popular certification body, Ecoinspect, registered since 2002 in Cluj Napoca, has also a national coverage, but with a stronger presence in Bistrita Nasaud, Mures, Suceava and Salaj (representing 53% of the issued certificates in 2014 by the respective certification body).

Ceres Happurg GMBH Sucursala Iernut România, the third certification body by number of the organically certified operators,

has a strong presence in Bistrita Nasaud, Suceava, Caras Severin, where 76% of the certificates issued for 2014. This certification body was closed as a subsidiary of Ceres Happurg GMBH on 28 November 2014 and registered as a Romanian company - Ceres Organic Cert SRL (RO-ECO-024) during the same year. The Romanian organic operators were not affected by this change, as their organic certificates are still valid.

At the moment of writing the article, another certification body - Bio Cert Tradițional SRL -was present on the website of the MARD on the list of authorised certification bodies, but no data on certificates issued was available. The certificates that are issued by this certification body will be present in the statistics of 2015, as the certification body is authorised starting with April 2015.

Correlating the information regarding the certificates issued per county with the distribution of the top three certification bodies, an interesting dynamics can be observed. Ecocert is clearly the leader in Caras Severin and Alba counties during the entire analysed period. In Suceava most certificates are prepared by BCS Öko-Garantie România (RO-ECO-001) while in Bistrita Nasaud Ceres Happurg is the main provider of certification services for operators. So, as a partial conclusion from the available data, when a certification body has a strong presence in a specific county, it tends to maintain its market share.

Referring only to 2014, only four counties registered more than 1000 certifications, irrespective of certification body that issued them. The centre of the country is the most active in the organic sector while the south of the country the number of organic operators is clearly much lower. It is also interesting to note that the south of the country is a large plain, where mostly cereals are cultivated, mostly in the intensive conventional agriculture.

The market for organic certification in Romania in the analysed period is clearly a very dynamic one also from the perspective of certification bodies. As it can be observed in figure three, there is a significant oscillation of the number of certificates, as an important number of organic operators disappear from one year to another. For example, 3,699 of the organic operators in

2012 are not present in 2013 anymore. A similar case is found in 2014, when 2,006 operators that were certified during 2012-2013 are not certified anymore.

On the other hand, a number of 2,577 new operators appear in 2013 and are still certified in 2014. Moreover, 1,863 new organically certified operators appear in 2014, and they did not have a certificate in 2013 or 2012.

What is also interesting to note is that 199 operators applied and obtained an organic certificate in 2012 and 2014, but did not do so in 2013. These operators are scattered across all certification bodies, and represent less than 1% of the certified operators for all the certification bodies. For this phenomenon there could be several explanations, such as the status of organic was not confirmed, or the operator did not complete the formalities in time or choosing a certification body that is not registered in Romania but is authorised by some other competent authority. For the latter assumption, there is not data available, but it can be regarded as a possibility.

Figure 3 The dynamics of the no. of organically certified operators by year of certification

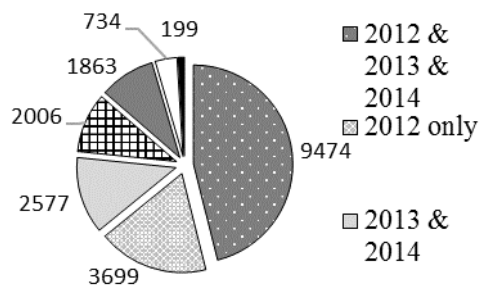

Source: own calculation

A different type of movement in the organic market in Romania is the migration of operators from one certification body to another, which is not uncommon. During 2012-2014 there were identified 1183 organic operators that switched certification body. The organically certified operators were identified as migration by comparing the name and the address of the entity certified – either natural person or company. In the case of the natural persons, if for example the husband was on the certificate at

certification body A and then the next year the wife is on the certification of the certification body B, the migration is much harder to identify and data reliance decreases. The certification bodies do not disclose such data.

As mentioned before, all certification bodies must be authorised by MARD. Therefore, it is important to mention that as Certorganic (RO-ECO-003) did not receive authorisation from the MARD in 2014, the operators were forced to choose a different certification body if they wanted to continue to be certified. During the analysis of the certification data, only 137 of the 338 (40%) migrated to a different certification body. Of course, the number could be higher, if we can assume that in the case of the natural persons, if in 2013 the certificate was issued in the name of the husband (for example) and in 2014 the certificate was issued by a different certification body in the name of the wife and vice versa. Another important assumption is that some of the organic operators might have lost faith in the system altogether in the moment that Certorganic lost its authorisation. What is very interesting is that this particular issue did not get any media coverage at the moment it happened or afterwards.

### 3. Conclusions

In 2012, in Romania organic agriculture occupied only 2.1% of the agricultural land, and compared to countries like Germany, Denmark or Spain where the surface of the organically cultivated land represents around 6.4%, we can anticipate further growth as the organic practices and principles are still at the beginning of their journey of implementation. However, there is a significant difference apparently between the potential and the evolution in practice.

This article aimed to review and explain the dynamic of the organically certified operators in Romania. As it can be observed in the analysed period of 2012-2014, there is constant oscillation of the number of certificates per certification body, but usually the market leader is unchanged. This oscillation is due to migration of certified operators from one certification body to another, and also due to the fact that some operators decide to enter the system of

organic agriculture while others decide to exit.

Considering the total number of organically certified operators in 2014, a slight decreasing trend in the last three years can be observed. As the MARD usually post the data late, the trend for 2015 is difficult to estimate.

A reasonable conclusion at this point is that there is still a lot of growth potential in the organic market in Romania. Therefore, in order to further promote the increase of the organic market a good reputation of producers and adequate marketing are necessary.

#### 4. References

- [1] CERTCOST. 2012. "Report on total costs of three organic certification systems in six European countries with particular focus on organic supply chains." Retrieved from [http://www.certcost.org/Lib/CERTCOST/Deliverable/D21\\_B.pdf](http://www.certcost.org/Lib/CERTCOST/Deliverable/D21_B.pdf). [accessed September 2014]
- [2] Cult Market Research. 2010. – "Studiu de piață- Produse bio." [Market Study- Organic Products]– available at <http://cultresearch.wordpress.com/2010/09/14/studiu-de-piata-%E2%80%93produse-bio/> [accessed September 2015]
- [3] Dankers, C., Liu, P. 2003. Environmental and social standards, certification and labelling for cash crops (Vol. 2). T. Lawrence (Ed.). Food & Agriculture Organization of the United Nations, Rome
- [4] InfoMina. 2008. "Piața Bio din România" [Organic Market in Romania], available at <http://www.infomina.ro/pdf/Despre%20piata%20BIO%20din%20Ro.pdf> [accessed September 2015]
- [5] INS. 2012. – Anuarul Statistic 2011 [Statistical Yearbook 2011]; Institutul National de Statistica, Bucuresti
- [6] MARD. 2011. Operatorii inregistrati in agricultura ecologica la MADR [The operators registered in the organic agriculture system at MARD ] available at <http://www.madr.ro/pages/page.php?self=01&sub=0107&tz=010713> [accessed January 2013]
- [7] MARD. 2015. Dinamica operatorilor și a suprafețelor în agricultura ecologică [The dynamics of the operators and surfaces in the organic agriculture] retrieved from <http://www.madr.ro/ro/agricultura-ecologica/dinamica-operatorilor-si-a-suprafetelor-in-agricultura-ecologica.html> [accessed September 2015]
- [8] Munteanu, A. R. 2014. "The Potential Impact Of Group Certification For Organic Agriculture In Romania". *SEA-Practical Application of Science*, (4), 631-638.
- [9] Willer, H., Kilcher, L. 2015. The world of organic agriculture 2015. Frick and Bonn, IFOAM&FiBL.
- [10] Willer, H., Lernoud, J. 2013. Organic Agriculture Worldwide: Key results from the FiBL-IFOAM survey on organic agriculture worldwide 2013. Slide collection.

# Analysis of the Strategies Specific to Knowledge based Management

Dorinela Nancu  
„Ovidius” University of Constanta  
[cusudorinela@yahoo.com](mailto:cusudorinela@yahoo.com)

## Abstract

*Through this paper we propose to highlight specific strategies of the knowledge based management.*

*A characteristic of the knowledge based management is the attention given to knowledge within the company.*

*In all knowledge-based organization, knowledge is the main resource of the organization, crucial to its functioning towards the objectives set, so protecting them presents primary importance.*

*Within the company, knowledge is found in the company's workforce (human capital), the requirements and preferences of the clients (relational capital) in products and processes of the company (structural capital).*

*Therefore, knowledge based management strategies are actually strategies aiming human resources, production processes, products or services of a company and its clients.*

**Key words:** knowledge based management, strategies, types of knowledge-based strategies.

**J.E.L. classification :** D 80, D83

## 1. Introduction

Knowledge based management consists in foregrounding knowledge within the company (as a resource, product strategy), which causes changes in managerial processes and relations. Knowledge based management consists of those methods and practices focused on the production and use of knowledge within the company, which ultimately increases business performance. Typical of knowledge based management within the company is the creation of a flexible environment, conducive to learning,

innovation, teamwork, development and use of ICT.

Knowledge based management involves appropriate strategies. Knowledge-based strategies are characterized by: [1]

- including knowledge, as an essential ingredient, in each component of the strategy (mission, objectives, resources, time);

- placing human resources – the major knowledge possessors, users and harnessers – on the forefront of strategy elements, together with knowledge;

- using modern information and communication treatment techniques, notably within the strategy;

- high flexibility manifested both within the strategy and in drafting and implementing it;

- the proliferation of participatory, motivational and innovative dimensions in substantiation, strategy development and implementation processes;

Regardless the type of the organization, the exercise of the management functions and relations is carried out through a system of management.

"The knowledge based management system can be defined as the assembly of elements with decisional, organizational, informational, motivational, human character, etc. within the knowledge based organization. Through this system, all management processes and relations are carried out in order to achieve the highest possible efficiency and sustainability, using proper knowledge resources and other resources." [2]

Knowledge based management system consists of several subsystems:

- decisional subsystem that includes all the decisions taken and implemented appropriate within the organization in accordance with the established objectives;

- methodological-managerial subsystem that includes all the methods and

techniques used in the performance of the management relations and functions;

➤ informational subsystem which includes all data, information, knowledge and means to deal with them in order to achieve the organization's objectives;

➤ organizational subsystem that includes all organizational elements that ensure the framework, the combination and functionality of the work processes in order to achieve the company objectives.

➤ the human resource management system which includes all mechanisms and processes through which is carried out the forecasting of staffing needs at work, the recruitment, selection, integration, training, evaluation, promotion processes of human resources and the development of an organizational culture focused on the goals of the organization through better use of knowledge.

## 2. Specific strategies of knowledge based management

Knowledge based management inevitably leads to the foundation of appropriate strategies called **knowledge-based strategies** within the knowledge-based organization. In order to achieve performance, this type of strategy is based on learning and innovation activities, conducted within the company, and on knowledge resources, which become the company's most important strategic resources. Compared to conventional strategies, **knowledge-based strategies have some specific elements:** [2]

□ including knowledge as an essential ingredient, in each component of the strategy, (mission, objectives, resources, timelines, strategic options, competitive advantage); objectives should refer expressly to the use and harness of knowledge;

□ placing human resources – the major knowledge possessors, users and harnessers – on the forefront of strategy elements, together with knowledge;

□ involving all stakeholders and employees within the strategy-building process. factors in developing and implementing knowledge-based strategies are: protection and development of intellectual capital, increased learning, promoting innovation within the organization, knowing one's competitors in

order to achieve the expected economic performance.

Like classical strategies, **the development of knowledge-based strategies** involves establishing clearly the components of the strategy: mission, objectives, resources, timelines, strategic options, competitive advantage.

The starting point in developing the strategy is to define more precisely the mission. The mission is the product of the interaction between the options of internal – the Board of Directors, shareholders/ associates, managers, employees – and external stakeholders – customers, suppliers, competitors, creditors.[3]

Knowledge-based strategy objectives must be realistic, understandable and stimulating. The resources involved in knowledge-based strategy development are knowledge, human, financial and material resources. Another component of the strategy is represented by strategy deadlines. The time factor gains great importance to the capitalization of strategy knowledge because the latter is subject to rapid wear. The goals, resources and deadlines involved within the strategy implicitly generate certain strategic options, which decisively determine the functionality of the company's strategy.

Informatization, training, the use of products incorporating knowledge, teamwork are just some examples of options used in order to achieve the strategy. [4]

The essence of a strategy is represented by obtaining a competitive advantage, i.e. a company product differentiation against the competition, either through reduced product cost, or through high quality.

## 3. The implementation of knowledge-based strategies

**The implementation of knowledge-based strategies** within knowledge-based organizations requires a rigorous process structured in several **stages:**

1. preparing the implementation of the strategy: herein, there are provided all the equipment, human, financial, information and knowledge elements, necessary in order to implement the strategy; there are organized meetings with the employees involved in strategy operationalization, in

order to achieve a positive involvement on their part;

2. reshaping the corporate culture and its management system: this phase involves building a knowledge based management system able to intensively capitalize the knowledge resources, in order to achieve organizational performance;

3. effectively operating the strategic changes that can target social elements of human (socio-professional improvement of employees), environmental (protection of the natural environment by reducing pollution, using alternative energy sources), technical (introducing new technologies with major implications regarding the company's productivity and profitability), economic (improving the mechanisms used in order to determine costs), management nature;

4. assessing the results of the knowledge-based strategy: in this phase, the effective results are compared to the objectives in order to grasp the effects of strategy implementation.

#### 4. Types of knowledge-based strategies

Within an organization, managers are faced with many decisions, dilemmas to solve. O. and C. Nicolescu presented in their book different **types of knowledge-based strategies** that can be applied in order to solve the problems faced by managers: 2

- Nemura-Ogiwara typology
- Hansen Nohria and Tierney typology
- Russ, Finerman and Jones typologies

**Nemura-Ogiwara typology** defines three categories of strategies depending on the level where the intended objectives are placed: **the strategy based on vision, the strategy based on professionals and strategies for emerging situations**. The strategy based on vision aims at solving the organization's problems by pooling the knowledge of a large number of people. This type of strategy is applied by Toyota Motor or British Petroleum. The strategy based on professionals implies intense human interactions in order to develop techniques and methods which can better harness the explicit but also (and especially) the tacit knowledge of the organization members. Such strategies are practiced by

PriceWaterhouse or by the World Bank. The strategy for emerging situations focuses on innovation, using intensely the knowledge of employees and customers.

**Hansen, Nohria and Tierney typology** defines two types of strategies: **the codification strategy and the personalization strategy**. The codification strategy is based on coding and storing explicit knowledge in databases that can be easily accessed and used by any member of the organization, requiring massive investment in technical information. The personalization strategy is based on the interaction between the members of the organization for the development and sharing of tacit knowledge among them.

**Russ, Finerman and Jones typologies** are more analytical than the previous ones; they are based on different combinations of discovery, codification and exploitation of knowledge.

#### 5. Conclusions

Knowledge based management consists of those methods and practices focused on the production and use of knowledge within the company, which ultimately increases business performance therefore a primary characteristic of the knowledge based management is the attention given to knowledge resources within the company.

The knowledge based management system consists of several subsystems such as: decisional subsystem, methodological-managerial informational subsystem, organizational subsystem, the human resource management system.

Knowledge based management inevitably leads to the foundation of appropriate strategies called **knowledge-based strategies**

Knowledge based management strategies are actually strategies focused on human resources, production processes, products or services of a company and its clients.

Between classical management strategies and those based on knowledge there are some similarities. Like classical strategies, the development of knowledge-based strategies involves establishing clearly the components of the strategy: mission, objectives, resources, timelines, strategic options, competitive advantage.

Compared to conventional strategies,



knowledge-based strategies have some specific elements. The most important is including knowledge as an essential ingredient, in each component of the strategy,

As we have seen from the above research, the implementation of knowledge-based strategies within knowledge-based organizations requires a rigorous process structured in several stages.

Along various researches there have been shaped several types of knowledge-based strategies that can be applied in order to solve the problems faced by managers, like Nemura-Ogiwara typology, Hansen Nohria and Tierney typology, Russ, Finerman and Jones typologies

## 6. References

- [1] Ovidiu Nicolescu, Luminița Nicolescu, *Economia, firma și managementul bazat pe cunoștințe*, Economică Publishing, Bucharest, 2005, pp. 218-219
- [2] Ovidiu Nicolescu, Ciprian Nicolescu, *Organizația și managementul bazate pe cunoștințe. Teorie, metodologie, studii de caz și baterii de teste*, Pro Universitaria Publishing, Bucharest, 2011, pp. 251-258
- [3] Ken Blanchard, *Leading at a higher level*, Pearson Ed. (Ebook Edition), 2010
- [4] Ovidiu Nicolescu, Ciprian Nicolescu, *Intreprenoriatul și managementul întreprinderilor mici și mijlocii*, Economică Publishing, Bucharest, 2008

# Quality Strategies Used by Market Leader in the Competitive Coffee Industry

Nicoleta Andreea Neacșu  
*Transilvania University of Brașov*  
[deea\\_neacsu@yahoo.com](mailto:deea_neacsu@yahoo.com)  
Oana Bărbulescu  
*Transilvania University of Brașov*  
[oana.barbulescu@unitbv.ro](mailto:oana.barbulescu@unitbv.ro)

## Abstract

*In Romania, the cafes market has experienced lately a significant growth, the competition becoming very strong. Starbucks is a great company known worldwide, it is the biggest chain of coffee shops in the world, being a world leader in coffee roasting and retailing.*

*This paper aims to study the quality strategies used by Starbucks over the time, strategies that have made the company to become the market leader and being appreciated by millions of consumers worldwide.*

**Key words:** quality, coffee market, strategy

**J.E.L. classification:** M16, M31, F23

## 1. Introduction

The worldwide trends in terms of increasing standards of living as well as 'the maturation of consumers' have determined mutations in the structure of consumer demands that have begun to ask for goods and services more and more sophisticated, they have become more demanding in as far as the quality terms and authenticity of the offer are concerned. [1] At the same time, the intensification of the competition has made the issue of competitiveness to be represented in other terms; the main factors that influence are the quality, price - quality ratio, renewal, diversification, innovation, knowledge and customer orientation [2].

As a result, the assurance of competitiveness must be based on quality, which is a way to ensure the company's competitiveness and implicitly company's

credibility on the market [3]. In essence, TQM is a philosophy of business management dealing with getting continuous improvement of customer satisfaction through quality management products and services, led in the entire company. TQM is a new approach to corporate management by applying total quality ideas across the organization [4].

Starbucks represents a strong brand created over time, since the '70s when for the first time the Starbucks coffee was brewed, being accessible in the shops and cafes in the largest cities in the world. Similarly, it is recognized for the services offered to its clients (the unique experience brought by Starbucks).

## 2. Café market in Romania

In Romania, the cafes market has experienced lately a significant growth, the competition becoming very strong. Thus, the established cafes in Romania were joined by: Starbucks, CofeeRight, Cremcaffè, Turabo Café, a special development being that of the Gloria Jean's Coffees chain. Moreover, a new franchise in from South Africa, founded in 2001, Manuka Cafe & Wine, which combines the concepts of café, restaurant and fine wine shop, entered the market.

With Starbucks, the 'packaged' coffee promoted by Gloria's Jeans and CoffeRight, Gregory's brand, has come high in Romanians' preferences, being encouraged by their dynamic lifestyle, by the continuous development of the market and by the ever more varied preferences of consumers.

Packaged sales currently stand for 25% of the Starbucks sales in both locations in malls, but the American chain does not stop there.

On the Romanian market, Starbucks is 'dueling' against Gloria Jean's or the British Costa Coffee chain, present in Romania as early as 2006 in the Romană Square in the capital.

Although the café market is still in the early stages of development in Romania, it has an excellent potential, being very dynamic, lively and welcoming new players and new concepts. For a country where the tradition of coffee consumption already exists, it is estimated that people will develop an even stronger culture of coffee. The increasingly dynamic lifestyle in Romania makes investors more optimistic about the market potential.

### 3. The presentation of Starbucks

Original Starbucks was opened in 1971 in Seattle's Pike Place Market, Washington by three partners: the English teacher Jerry Baldwin, the history teacher Zev Siegel and the writer Gordon Bowker.

In 1982 Howard Schultz was hired as director of retail and marketing division at Starbucks. In one of his business trips to Milan, Howard was impressed by the Italian espresso bars and he set as goal to create a similar experience in the United States, the espresso coffee becoming the essential element of his vision. His bosses were not seized by the same enthusiasm, which made Schultz leave Starbucks in 1985 to found his own company, Il Giornale. Two years later, the Starbucks owners decided to sell their business, an opportunity that Schultz couldn't have missed and for which he paid \$ 3.8 million. Under the leadership of Howard Schultz, Il Giornale changed its name into Starbucks and it began its rapid expansion all over the US.

In 1992, the year the company was listed at the stock exchange, the Starbucks network already had 165 locations.

The first abroad branch was opened in 1996 in Tokyo, and in 1998 Starbucks entered the European market as well, the first locations being opened in the UK. Today, Starbucks means more than 14,000 cafes in 40 countries, about 45 million customers a week and 5 new locations opened every day.

The exponential rhythm of extension of the Starbucks cafes marked the history of this company, but it did not affect the basic

principles, that Schultz still wants to remain faithful to: a cup of good coffee and a soul-based company.

The company is named after Starbucks, the second captain in Herman Melville's Moby Dick and the logo of the company is represented by a double-tailed mermaid. The logo has undergone several changes over the years.

To begin with, Starbucks has classified coffee according to a spectrum of profiles: mild, smooth and strong [6].

- Light Coffee: House Blend Coffee, Colombian Nariño Supremo, Starbucks Breakfast Blend;
- Smooth Coffee: Verona Coffee, Guatemala Antique, Starbucks Espresso Roast;
- Strong coffee: Sumatra, Sulawesi, Starbucks Kenya

Starbucks first entered the European market in 1998, opening the first locations in the UK. Currently, the company has over 1,000 locations in Europe, in countries such as; the UK, Ireland, Austria, Switzerland, France, Spain, Germany, Greece, Cyprus and Turkey. Over 44 million customers visit Starbucks every week in 39 countries worldwide.

Starbucks entered the Romanian market on April 19, 2007, with the opening of the first location in Plaza Romania, by Starbucks Coffee Company and its European partner Marinopoulos Holding SARL, currently having locations in Bucharest and other cities in the country (Cluj-Napoca, Brasov, Timisoara). This is the first step in the strategic expansion of the company in Eastern Europe and it demonstrates their firm determination to develop in this region.

Starbucks offers to coffee lovers an exclusive selection of coffee (Arabica) brought from around the world: Latin America, Africa/ Arab countries and Asia/ Pacific.

### 4. Coffee quality

As any large-scale product in the globalized society where we live the coffee as well can be better or worse, depending on the variety it belongs to, on the growing conditions, processing, roasting and, of course, depending on the preparation methods of the final beverage.

The first step is represented by the cultivation and processing of green coffee. At this stage, the emphasis is laid on the quality of the soil where coffee is grown, the complete absence or minimal presence of chemical substances in the cultivation and processing process, but equally the protection and fair treatment of farmers growing coffee are taken into account.

The surfaces cultivated with coffee today exceed 12 million hectares, and most of the coffee plantations are located in areas considered highly important for biodiversity conservation and sustainable development.

Consequently, the certification system of coffee crops has emerged and developed as an absolute necessity for the protection of both farmers and the preservation of biodiversity and for the development according to sustainability criteria of the regions the green coffee beans come from.

About 80 varieties of coffee are known, of which for industrial and especially economic reasons the following four types of coffee are cultivated: the Arabica coffee, the Robusta coffee, the Liberica Coffee and the Maragogype coffee. Two of these sorts are more important from a commercial point of view: the Arabica coffee and the Canephora (Robusta) Coffee.

**The Arabica coffee** original from Africa, to be more precise from Abyssinia, is the most appreciated and most widespread species of coffee. It is cultivated mostly in Latin America but in Africa as well, actually it is the most cultivated species and it is particularly appreciated for its high quality elongated greenish-bluish beans. The Arabica coffee grows best at high altitudes, it has a flavor much more refined than other species, and it contains about 1% caffeine per weight.

**The Robusta coffee**, just as the name indicates, is a stronger species, resistant to disease, with high production per plant. It blooms at lower altitudes and it produces coffee with harsher, less refined flavors. It is grown extensively in Africa, India and Indonesia. The Robusta coffee, unlike the Arabica, which is sensitive to the climatic conditions, adjusts easily to the severe weather, and it is resistant to diseases and pests. The beans of this species are small, having an irregular shape and a brownish-yellowish color. The Robusta is a coffee with lower qualities than those of the Arabica. Its

taste is deep, slightly astringent - bitter, the caffeine is present by 50% more than in the Arabica, but the flavor is weaker. The Robusta is used mostly for instant coffee, but also in blends with the Arabica, which increases its quality.

An important aspect in getting the complex taste and the unique aroma is **the process of roasting** the coffee beans.

- The American method is an average roasting, with the beans being brown-colored and a refined coffee aroma;
- The Italian method is an intense roasting, with the beans being dark brown and shiny and an intense aroma of coffee suitable for espresso

In order to prepare the green coffee beans, as in the case of pebbles, for the roasting process, the growers process them by using two methods: natural or washing.

By *the natural method*, the ripe fruit of the coffee tree is left to dry in the tree or on the ground until the beans decorticate. By *the washing method*, the beans are finely extracted as soon as possible from the fruit right after the gathering, then they are submerged in a vat of water, and then they are dried on large patios or by the help of modern equipment.

The green coffee beans are heated in a large rotating drum which rotates continuously, thus beginning their transformation. After about 5 to 7 minutes of intense heat, most of their moisture evaporates. The beans turn yellow and smell like popcorn. After about eight minutes of roasting, the first 'pop' appears. The beans double their size, crackling as they expand. Now they are light brown and sour one-dimensional flavors dominate, lacking any flavor profundity because it has not developed yet.

After 10-11 minutes of roasting, the beans turn dark brown, and oils start to appear on their surface. At this moment (different for each coffee species, but usually between 11 and 15 minutes), the full flavor potential begins to develop in the beans, balancing all of their attributes. 'The second pop' signals that the coffee roasting is almost over.

Roasting triggers all physical and chemical changes of the green beans: the weight of the beans is reduced by 16%, they double in volume, the color changes from pale green to intense brown and they get the

specific taste and aroma. An essential condition of roasting is to spread the heat so that all beans are roasted on all sides equally and simultaneously. The temperature and the duration of the roasting process are carefully controlled in order for the coffee not to lose the aroma. Generally, mild roasting gives beans a milder flavor, the medium roasting produces a well-defined and rich aroma and the strong roasting gives a strong and distinct aroma.

**The Grinding of the coffee** For each preparation method it requires a different degree of grinding, because the final taste of the coffee is influenced by the time that water and coffee are in direct contact. For example, when the coffee is prepared in a coffee machine, it must be ground more, because the contact time between water and coffee is of about four minutes while the coffee prepared for an espresso should be finely ground because its preparation takes about 20 seconds. The shorter the preparation time, the finer the coffee should be.

**The dosage of the coffee** One of the most important steps in the preparation of a good coffee is to use of the right proportion of coffee and water. This proportion differs depending on the recipe. The best quantities are made by combining various types of coffee from various parts of the world. Their various properties and characteristics combine to ensure equilibrium of aroma and flavor. Blends of pure Arabica varieties tend to a more moderate and aromatic coffee, whereas Arabica and Robusta blends have a richer consistency and a stronger flavor.

**Water** A cup of coffee contains 98% water, therefore the water used to brew the coffee must be clean. In order to get the taste and the aroma of the coffee the water should be heated at about the boiling point: 96 ° C.

**The freshness of the coffee** As with any other food, it is advisable for the coffee to be consumed fresh. The oxygen, the heat, the light and the moisture are the main factors that lead to the loss of coffee's quality. In order to maintain the freshness of the coffee, it must be kept in an opaque, airtight container, at room temperature. It is not recommended, in the case of the daily used coffee, to keep it in the refrigerator or freezer, because the hot air that gets into the container every time you use condenses. The coffee beans are kept fresh far longer than the

ground one, because the area of contact with the oxygen is much reduced. Therefore, for the best results the coffee must be ground before use.

The best known and the most important certifications for coffee are: Rainforest Alliance, USDA Organic, Fairtrade International and UTZ Certified.

- **Rainforest Alliance** focuses on the certification from the perspective of environmental protection but it goes further by covering other issues such as the relationships within the community and the fair treatment from the perspective of human rights of those who work on farms where coffee is grown.
- **USDA Organic** is a standard American certification. The products certified by this standard are 100% organic grown on a soil that has not been treated for at least 3 years with synthetic fertilizers, pesticides or herbicides.
- **UTZ Certified** puts special emphasis on transparency and the easiness of the observation of the supplying and administrative process of farms, of some efficient agricultural practices, the prevention of soil erosion, the minimization of water consumption and pollution, the responsible use of chemicals and the protection of the habitat.

The standards presented above are the most important and simultaneously the best known certification standards for coffee. The certifications are important [5] primarily because they support farmers work and the efficient and sustainable coffee production, and secondly because they bring to each of us a coffee cup of the highest quality.

## 5. Quality policy at Starbucks

One of the examples referring to the quality of the Starbucks coffee is represented by the beans from Kenya by which the company has developed the initiative of social responsibility by the acquisition of coffee from local farmers called C.A.F.E (Coffee and Farmer Equity) Practices promoting social economic and environment standards, together with verified and certified external programs, by which Starbucks buys beans from Kenya and not only. From these beans results a strong quality coffee, because they

are freshly ground once an hour, several times a day, using the 'flash roasting' method.

Starbucks buys only the best quality Arabica coffees available. Most of the coffee is grown between the Tropic of Cancer and the Tropic of Capricorn, on plantations in Africa and Arabia, Latin America and the Pacific Islands. Because in each of these regions the soil and the climate are different and different processing methods of the coffee, the taste of coffee varies greatly from one region to another.

Starbucks is one of the best known and best tasting coffees in the world. This is due to the quality level of products and services offered, from which it has not deviated over time. The company strongly focuses on customer satisfaction. Starbucks coffee shops are designed to offer customers the ability to drink their coffee in a cozy and relaxing atmosphere. The friendly and always ready-to-serve-customer personnel completes this picture. The recipe for Starbucks' success is that it adapts to the culture and preferences of consumers in a country.

Starbucks has always offered clients a pleasant atmosphere in a market where by the late '90s, few restaurants had air conditioning. Thus, Starbucks quickly became a meeting place for both business and groups of friends. Starbucks uses different quality strategies, such as [7]:

- **Fairtrade™ certified coffee** The Fairtrade certified coffee is one of the ways in which Starbucks fulfills its commitment to the areas of origin of the coffee. The FairTrade movement is based on the same principles as Starbucks coffee purchasing standards: the negotiation of right prices, engaging in long-term relationships, direct communication with producers, the investment in social and community projects, and the protection of the environment.
- **Fairtrade™ Certified Prices** In the Fairtrade™ certification system, the importers, the roasters and the retailers purchase coffee from farmers who are registered in the International Fairtrade Labelling Organizations, at favorable guaranteed prices.
- **Providing Fairtrade™ coffee to the whole world** As early as the formation of an alliance with TransFair USA in April 2000, Starbucks purchased 900,000

kilograms of coffee Fairtrade™ certified, including 500,000 kilograms in the fiscal year 2002. The acquisitions have increased progressively. Starbucks is licensed to sell Fairtrade™ certified coffee in 17 countries, including Australia, Austria, Canada, China, Germany, Hong Kong, Japan, Korea, Malaysia, New Zealand, Philippines, Spain, Switzerland, Taiwan, Thailand, the United Kingdom and the United States of America.

- **Working with Fairtrade™ farmers** In July 2002, Starbucks, the Ford and Oxfam Foundation America announced a pilot project in collaboration with a large Fairtrade cooperative in Oaxaca, Mexico. This project aims to increase the supply of existing quality coffee, certified Fairtrade™ coffee and to enable the 16,000 participating farmers to earn premium prices for their crops. By providing farmers with tools to improve their skills, they ensure the improvement of quality coffee that they cultivate and it is desirable to increase their living opportunities without assistance from the outside.
- **Selection rules of coffee providers** In November 2001, Starbucks introduced an unprecedented set of rules for purchasing coffee in order to encourage the sustainable production of high quality coffee. Implemented with the support of Conservation International's Center by means of the Environmental Leadership in Business center, the rules reward farmers and suppliers who meet the very important quality, environment, social and economic criteria with financial incentives and a preferred supplier status.
- **Organic Coffee** Organic coffee is grown without the use of synthetic pesticides, herbicides or chemical fertilizers. These cultivation methods help maintain a healthy environment and clean underground water. Starbucks offers coffee that is organically certified since 2000. Most coffees that Starbucks buy are grown using organic methods, but they are not certified as such. The official certification necessitates the consent of growers to undergo tests of soil testing for three years and yearly testing afterwards

to ensure the fact that accepted organic cultivation methods are used.

- **'The voice of the consumer'** The comprehension of consumers and the satisfaction of their needs;
- **Service experience** Starbucks is a master in the packaging of its products. The choice of the furniture and accessories, the names of their beverages, the messages on cups, the graphics that were studiously worked on.
- **The motivation of employees** The Starbucks employees have the opportunity of being more than just employees, they are the partners of the company. The giant possibilities are before the beginning of the program, they have the opportunity to develop on a personal level in their career and in the community.

## 6. Conclusions

Starbucks is the biggest coffee company in the world, being a world leader in coffee roasting and retailing, present in 44 countries, the profit being the result of 14,000 coffees sold daily. It provides coffee, espresso drinks, tea and bottled drinks.

In the second place, Starbucks represents the strong brand created over time, since the '70s when for the first time the Starbucks coffee was brewed, being accessible in the stores and cafés existing in the largest cities of the world. The customers are attracted by the unique dark-green logo and the stylized image of a mermaid that attracts the passers-by in cafes to have their products served, many of them standing in line to purchase coffee.

On the other hand, Starbucks offers quality at the highest level to its unique coffee products, having high standards (starting from the purchase of coffee beans, their roasting and their fresh serving), trying to make customers loyal and attracting new ones in each store. Starbucks offers coffee tastings when customers can touch the exposed beans, and having more confidence in what they consume.

At the same time, Starbucks cafes are modernized, they have a very special design which offers comfort, a relaxing, friendly space which provides facilities such as armchairs, equipped with tables where you can work on your laptop or notebook, taking

advantages of the free internet connection, the background jazz music or the clients can look out through the large windows. In a study conducted in several countries where Starbucks operates, the Starbucks coffee shops are considered the third place preferred by customers after their personal living and their work office because most of them spend more than 2 hours sipping the Starbucks products.

Starbucks is a competitive, innovative company by perfecting its authentic products, bringing added value to the brand liked by customers who prefer the quality and the services offered in shops by the employees who are highly trained and very attentive. They have their own measuring system for coffee: Tall (345 ml) - short version, Grande (475 ml) and Vendi (591 ml).

Starbucks remains devoted to serving the best coffees in the world and to offering its customers the finest coffee experience – producing at the same time economic and social benefits to the community in which it operates.

## 7. References

- [1] Bohoşievici C., *Asigurarea calităţii*. Tehnica-Info Publishing House, Chişinău, 2009.
- [2] Madar A., Neacşu N. A., Service quality analysis – Hotel Alpin (Poiana Braşov), *Annals of the "Constantin Brâncuşi" University of Târgu Jiu, Economy Series*, Issue 6/2013, 2013, pp. 267-270.
- [3] Rondelli V., Cojocariu S., *Managementul calităţii serviciilor din turism şi industria ospitalităţii*. THR-CG Publishing House, Bucureşti, 2005.
- [4] Madar A, Implementation of total quality management. Case study: British Airways, *Bulletin of the Transilvania University of Braşov , Economic Sciences*, Vol. 8 (57), 2015, pp. 126
- [5] Madar A, Neacşu N.A., *Quality management for products and services*, Lambert Academic Publishing, 2014
- [6] <http://www.businessinsider.com/starbucks-testing-nighttime-program-2013-7>
- [7] [www.starbucks.com](http://www.starbucks.com)

## Defining Influences Of Globalization On Education Management

Liliana Nicodim

*Faculty of Economics, "Ovidius" University, Constanta, Romania*  
[nicodimlili@yahoo.com](mailto:nicodimlili@yahoo.com)

George Bucăța

*„Lucian Blaga” University, Sibiu, Romania*  
[george.bucata@yahoo.ro](mailto:george.bucata@yahoo.ro)

Emanoil Muscalu

*Faculty of Economics, "Lucian Blaga" University, Sibiu, Romania*

### Abstract

*Globalization is an undeniable phenomenon today, which deeply affects systems. In its present meaning, the term globalization arose from acknowledging that the world is in a process through which it will become a sort of "global village" or, at least, a single economic system, political and socio-cultural. The globalization has changed the way education evolves, from the way people prepare for future challenges for the work environment up to the way education changes under the new factors and trends arising at a global level.*

**Keywords:** *education, globalization, education management*

**JEL Classification:** M1, M14

### 1. Introduction

The 21st century marks the transition from the industrial society to the knowledge-based and cultural society, and the concept of sustainable development encompasses, in addition to the three initial components: economic development, social development, protection of the environment (environmental aspect) and the cultural component and a component to ensure international security, national and regional. International security, national and regional development represents the appropriate framework of the four components of sustainable development. In any economy, education is an integral part of the social infrastructure and an essential component of social consumption. Modern society has entered a period of rapid and deep transformation of economic, social and

political context of a new framework of knowledge conducted in an entrepreneurial educational system. Economic globalization is carried out in the conditions of formation of hipercompetitive markets, demographic, ethnic and cultural diversity, information technologies, biotechnologies and nanotechnologies.

### 2. Literature review

The World Trade Organization (WTO) Director-General, Pascal Lamy (2006) proposes that Globalization can be defined as an historical stage of accelerated expansion of market capitalism, like the one experienced in the 19th century with the industrial revolution. It is a fundamental transformation in societies because of the recent technological revolution which has led to a recombining of the economic and social forces on a new territorial dimension.

Globalization is one of the most discussed concepts across the disciplines but still remains elusive and confounded. In this respect, the debate taking place in the literature on globalization is two-pronged as the definition of the meaning of globalization is still not consensual and its impacts on local cultures are yet to be circumvented. One thing that is definite and sure is that globalization is multidimensional and has economic, cultural, social and political aspects which impact both individuals and societies. More specifically, globalization constitutes a policy and/or system that promotes global interaction interdependence and interconnection among nations through advanced technologies. As is, globalization refers to both the aspiration and determination to make a way of life



applicable throughout the world, hence contributing to uniformizing ideas and systems of ideas in every single part of the world.

Many views regarding globalization either extol it for the interdependence, connectivity and flow of information it has made possible in all spheres of human life, while others deem it responsible for the dilution of culture and dissemination of 'western' values; in other words a new form of imperialism known as cultural imperialism [1]. Education in the global era is faced with problems that fall in two areas, that of difference and the other of complexity. "With global migrations come new demographic realities and cultural formations. These two aspects of difference and complexity have their effects on both developed and developing nations, though the degree to which each has its impact can vary [2].

### 3. Knowledge: asset for globalization of education in the higher education system

People link higher education and training to global citizenship education in the context of promoting multiculturalism. All of this, takes place in the context of economic globalization, in which future organizations rely on intangible and inexhaustible resources, and most of all: knowledge. Organizations that rely mostly on tangible resource (material resources) have a low life expectancy, while organizations that rely on knowledge-inexhaustible resource, whose development is exponential - can be considered organizations of the future.

In general, the knowledge available to all, can be found in the databases accessible in various forms. The difference between the organizations in the same industry and carrying out similar products is precisely how that company knows to turn knowledge into knowledge-Know-how.

In this context, the important role of universities is to produce knowledge and, in some cases, to develop knowledge through research institutes and centres of innovation and technology transfer.

The role of universities in the context of globalization is much more complex, and there are constraints and open competition at an international level. The process of aging, particularly in developed countries, produces

imbalances between educational needs and educational capacity. As a consequence, the system of public funding is focused on priority: health; social security schemes; national security; so higher education system tends to become increasingly more dependent on private sector: school fees, charitable acts, capitalizing on intellectual property [3]. Moreover, in a knowledge-based economy, many governments adopted that opinion: higher education confers primarily a private benefit to students and other sponsors of the university and the sideline makes a public that would benefit society as a whole.

Fig 1. Connecting Globalization and Education

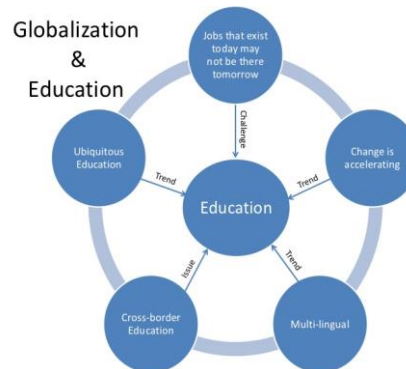

Another aspect of the current situation of the market refers to the fierce competition that takes place at the level of higher education on three levels: competition between students, teachers and resources; competition among State universities and private universities; the competition between Nations. If private universities were created in the beginning to satisfy a marketplace, elite private universities currently step away from elites area, far below the standard of training of those in public education.

The development process of ranking universities in terms of qualitative measures of various hypothetical publications: the so-called performance ranking standings-who first appeared in the United States and the United Kingdom, and now have spread worldwide is an indicator of the pressures of the market. All this creates a tremendous pressure on the University to diversify the sources of funding through mechanisms such as: tax hikes, create partnerships with business and economic environment, encouraging charitable acts and expanding

the market for educational services addressed to adults and foreign students [4].

#### **4. Global competition between universities.**

Global competition between universities is opened, in the context of a high level of institutional autonomy which allows the expression of creativity and flexibility in a constantly changing world. An autonomous University has the freedom of own design curricula; establishment of fees; the selection of students; the selection of teachers; determining the level of pay; establishing development plans, etc [5].

Promoting the image of a University represents an important strategy of the university management. In this context, the internationalization of the university must take into account the following: the number of foreign students; the number of invited professors from abroad; the number of teachers holding university courses abroad; the number of programmes of study in foreign languages; the number of studies at universities abroad; the number of licensing, double; the number of PhDs, number of university publications in foreign languages; the number of international projects coordinator and partner; the number of international agreements (ERASMUS, etc.); the number of International university consortia; the number of international academic bodies in which it participates; the number of international collaborative agreements; the number of international

awards; the number of international conferences organized and participation; curricular offer e-Learning in foreign languages.

Educational globalization representing only a component of globalization, educational globalization targeting economic issues, cultural and even political represent other components. Economic globalization, as a result of the spread of transnational corporations worldwide has opened opportunities in what globalization means. Opening branches of universities or even campuses in other countries, with positioning in these countries to foreign companies is another argument of globalization. This is a refined form of a modern colonization, in which chase after material resources is replaced with HR rush: "heads hunting".

In this sense, American universities are particularly active in searching for the best and brightest students and researchers. Public availability of the software for educational purposes and the opening of universities with placement and academic educational materials (course work) publicly available on line, as well as digital libraries creates conditions of development of distance education and virtual universities. It is estimated that in the near future, it is possible that anyone who possesses the most modest mobile technology or the Internet can access much of the knowledge recorded by our civilization along with opportunities for study.

Fig 2. Strengthening of an education organization

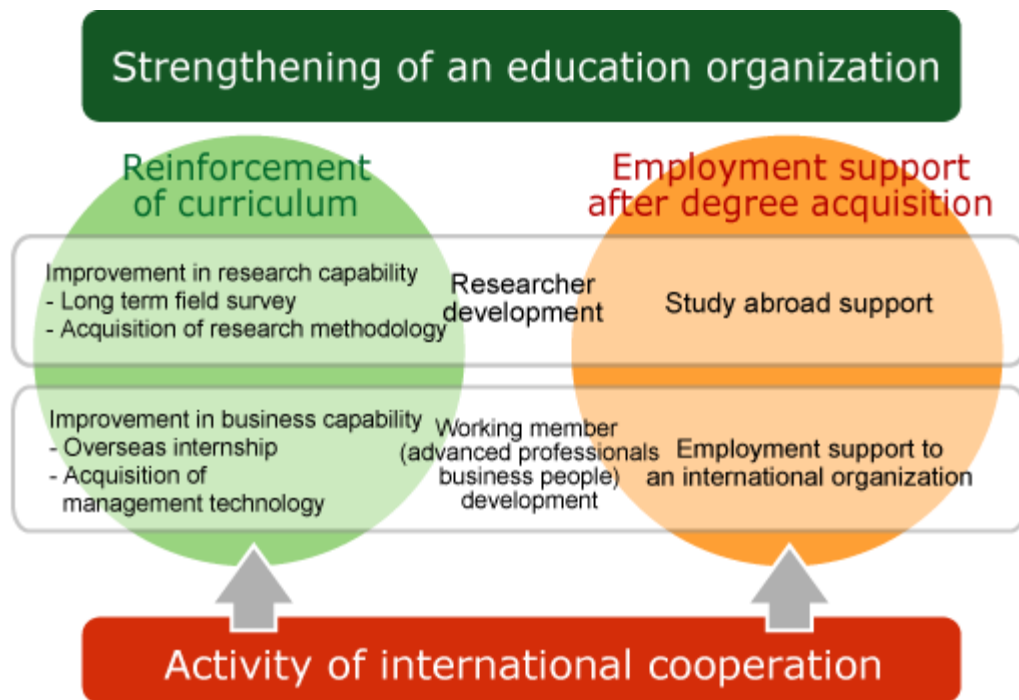

In order to achieve sustainable development through the sustainable development of higher education devoted to prestigious universities, people should help to strengthen the competence of universities in developing countries, and the quality standards submitted by these countries may not be lower than those of developed countries [6]. They should support the development process and not to exploit this market. It is absolutely necessary to provide the conditions to move from "brain drain" to "brain circulation" for which Governments are responsible to encourage and motivate through concrete measures return to the country of origin of those who win the professional experience in the developed countries.

In order for universities to become responsible members of the global community, in a knowledge-based global economy, it is the need for the formation of citizens involved, independent and with a global identity. In this context, universities need a broad platform of partnerships and the support of governments. Thus, the increase in resources from the private sector for higher education could come through major changes in fiscal policy, allowing the lowering of taxes for charitable contributions and sponsorships. The combined economy of private and public support given to higher

education will be a significant pattern of the future.

### 5. Effects of educational globalization

One obvious effect of globalisation was the tendency of internationalization of education, transposed in the mobility of pupils, students and teachers (through European Union programmes-Erasmus, Lingua, Tempus, Comett, Petra, Alpha, Comenius, Leonardo). The international dimension of the curriculum was to encourage numerous states to boost cooperation in the fields of education and bilingualism, as answer to the needs of the contemporary world [7].

Exchanges of opinion between educational subjects have been systematically supported by international organisations such as the OECD (Organisation for Economic Co-operation and Development), CEDEFOP (European Centre for the Development of Vocational Training), UNESCO (United Nations Educational, Scientific and Cultural Organisation), WB (World Bank).

The communicational and informational channels (e-mail, Internet, video-conferences) have created alternative ways of e-learning. The informational technology creates the possibility that higher education and sometimes the course to be independent

of time and space context. The increase educational exchanges, internationalization of the curriculum, changing products under the impact of information technologies, are realities of the contemporary world, thus being arguments in support of the argument that the globalised world is a reality.

Developing new tools for education, new educational products, appear from the methodology of programmes intended to enlarge the field of knowledge of the participant in the exchange programs. The new world needs developing school programs for the protection of the natural environment and social, training of leaders, development of entrepreneurial quality, involving primarily the new attitude: fight against discrimination, multiculturalism, intercultural exchange acceptance. Students will learn to find the necessary information, to use modern means of investigation of information, to design an in-house legal career path in school period. The teacher's role will be decisive in the line of critical thinking, complex analytical side, that students will use on all lifetime. In fact the learning methods, teaching and assessment in the case of lifelong learning, propose a different model from the one traditionally in which the roles of key players-teachers and pupils have been redesigned.

## 6. Conclusion

Education has a fundamental role in the development of the individual and of the society, being "one of the principal means available to foster a form of human development more and more harmonious located" and "not a miraculous cure or a magical formula permitting the opening of gates towards a world where all ideals can be achieved." The world in which we live can currently be defined as a global arena, a planet increasingly more populated, who faces a real problem-demographic growth and hence increase the number of young people. Educational policies should reflect the responsibility of building a world grounded in a larger extent on the support of each other.

In fact, the globalisation of education is achieved by: increasing the offer of educational programmes of study, allowing appropriate skills training concept sustainable

employability (brain workers) in the context of world population growth from 1.65 billion in 1900 to 6.6 billion in 2007, while in 2050 it is predicted to register 9 billion; imbalances between the educational needs and educational capacity, the need for the involvement of universities in developed countries strongly to create "sustainable universities" in developing countries, which should be developed on the basis of sustainable programmes of study that provide useful knowledge (useful knowledge), increasing global competition at all levels, in an "ecosystem of education", increasing the level of information and communication, the development of new models of economic support concerning public and private, the development of partnerships with the economic, social and cultural.

## 7. References

- [1] Al'abri, K. 2011. The Impact of Globalization on Education Policy of Developing Countries: Oman as an Example. *Literacy Information and Computer Education Journal (LICEJ)*, 2 (4), pp. 491-502.
- [2] Crossley, M. 2002. Comparative and International Education: Contemporary Challenges, Reconceptualization and New Directions for the Field. *Current Issues in Comparative Education*, Teachers College, Columbia University, 4 (2), pp. 81-86.
- [3] Altbach, P. G., & Knight, J. (2007). "The Internationalization of Higher Education: Motivations and Realities". *Journal of Studies in International Education*, 11(3-4): 290-305.
- [4] Deem, R. (2008). "Producing and Re/Producing the Global University in the 21st Century: Researcher Perspectives and Policy Consequences". *Higher Education Policy*, 21(4): 439-456.
- [5] Hwang, S., & Roth, W.-M. (2008). "Learning Science in an Era of Globalization: A Phenomenology of the Foreign/Strange". *Cultural Studies of Science Education*, 3(4): 937-958
- [6] *Lifelong Learning in the Global Knowledge Society: Challenges for Developing Countries*, A World Bank Report, 2013
- [7] Skinner, R. A. (2008). "The Challenges of Transnational Online Learning". *Journal of Asynchronous Learning Networks*, 12(2): 83-89.

# Customer Relationship Management Using Information Technology

Oana Nițu

*Faculty of Economics, "Ovidius" University, Constanta, Romania*

[oana.oprisan@yahoo.com](mailto:oana.oprisan@yahoo.com)

Claudiu Valentin Nițu

*Faculty of touristic and commercial management,  
„Dimitrie Cantemir” University, Bucharest, Romania*

[valynitu@gmail.com](mailto:valynitu@gmail.com)

Cosmin Tileagă

*Faculty of Economics, "Lucian Blaga" University, Sibiu, Romania*

[cosmin.tileaga@yahoo.com](mailto:cosmin.tileaga@yahoo.com)

## Abstract

*A CRM system very good implemented and used within a company will lead to increased sales, improved quality of sales process, productivity increase and successful achieving of the developed projects in companies, providing visibility into all the activities of the organisation.*

*However, there is a CRM view that is strictly focused on information technology. This new perspective gives us the tools for a real overview of customers, tools that can be used to facilitate sales success and to improve customer relationships.*

**Keywords:** CRM, SCRM, companies,

**JEL Classification:** M1, M2, M3

## 1. Introduction

In implementating of a CRM strategy, information technology plays a fundamental role in order to maximize profitability through a fine segmentation of the market. We are in the information technology era, involving a close link between a company and its customers, due to the emergence of databases, integrated computer systems, data warehouses, conveniences of the Internet, etc. All these technologies leads to share and customer profitability increases.

Information technology assists various management processes of data and knowledges, aimed at understanding customer needs, so the most effective CRM strategies can be adopted. In addition, use of information technology makes it possible to

collect data needed to determine profitability and to maintain customer acquisition.

The research shows that an increase of 5% in customer retention induces an increase of the profits in terms of present net value, of between 20-125%. Although managers know the importance of keeping customers, a few of them know the impact on profit of close relationships with customers. As a result, they often do not adopt the most effective strategies for customer acquisition and retention.

Due to the beneficial effect of keeping customers on profitability, companies are increasingly turning more and more information technology to increase customer loyalty. To improve customer retention are required three steps: measuring the rate of customer retention, identify the causes of customer dissatisfaction and implement corrective actions.

To measure the rate of customer retention a group of researchers in the field of CRM at the Institute Cranfield (UK) has developed a model they called "Retention Gram" that allows managers to determine the impact of some customers retaining factors on profitability: cost of acquisition, the number of new customers conquered, apprehended customers profitability and customer retention rate. To facilitate the processes within this model requires sales force automation and creation of contact centers, web and client-server based.

Retention Gram model involves creating an IT platform consisting of computer networks, databases, data warehouses and integrated software offering CRM solutions. The ultimate goal of this model is to find and

identify new opportunities for customer retention.

Another model that describes the links between employee attitudes, customer retention, their loyalty and company profitability, is the chain "service-client-profit" developed by Harvard Business School [1]. In this model they are highlighted five key elements: customers, employees, innovation, financial performance and values of the company, and the obstacles that arise in the relationship company - customers.

Companies need to know what management actions should take (Ex: Investment in training of the sales force in the IT sector, calling for e-CRM action on a Web Call Center, etc.) in order to improve customer satisfaction and their retention. This model has been applied to Roebuck & Co. trading company, where the results were impressive: there have been identified links between customer satisfaction as a result of e-CRM solutions applied, and profitability indicators of the company concerned.

The attitude of employees towards the company was considered critical to customers approach, while customers impression due to e-CRM strategies positively affected their retention. The system is used as a forecasting revenue growth: an increase of 5 units of employee attitude determines an increase of 1.3 units in customers impression, and 0.5 units in revenues increase, and if the customers database system get integrated it can lead to an increase of 4 units in customers feeling, which causes a significant increase in revenue.

## **2. Design and implementation of a CRM system within the company**

In a CRM project will participate employees in Sales, Marketing, Technical Support, Finance and Accounting, as well as IT specialists from inside or outside the company. In the organizational structure of the company will be held some temporary changes, creating a matrix structure specific to project management [2].

The team participatin in CRM project will actively interact with customers, giving them the support they need.

The CRM strategy is based on a client-server technology with which it can quickly

be distributed digital information between team members participating in the project. As IT support they are used software for facilitating teamwork, as well as various web applications.

Sales department benefit from automated sales tool by which potential customers are identified based on their needs that are not satisfied or only partially satisfied.

Marketing department uses information technology for sales and cross promotion, commercial web presentations constituting ways of efficient promotion. Customization strategies of the offers become prevailing. For example [www.nike.com](http://www.nike.com) website customers are offered the opportunity to create their own sneakers, choosing their favorite color, damping, etc.

Technical Department collects in a database the technical problems sent by customers, providing them quickly with necessary technical assistance. It is known that after-sales service speed is an important factor in choosing an offer by customers.

Department of Finance - Accounting provides reports on customer profitability, presents the costs of a CRM strategy, coupled with expected revenues, costs of training the human resources involved in the process, etc.

Specialists in IT creates the informatic system infrastructure of interaction with customers and they are responsible for the proper functioning of the system and of the flow of information carried.

In order to assess the effectiveness of a CRM strategy, an important role is the feedback provided by customers, showing how the set objectives have been met.

Through the collaboration of these departments with specialists in IT should not lose any opportunity to sell and each client must receive promptly the goods or services ordered, assistance both during the purchase and after purchase, suggestions and loyalty customized programs.

Bill Gates [3] proposes to CRM project managers: "Spend information and buy time in share. Use digital tools to help customers to solve their own problems and book your time dedicated to personal contracts to respond to more important customer needs."

A company with a performing management realize the importance of the customer waiting for a personalized

treatment, which can be easily achieved with a CRM strategy.

If we consider the triangle project in a CRM strategy we can highlight its restrictions on time, budget and objectives.

CRM project plan duration can decrease because the company manager that adopts the project decided to reduce by 1/3 the time devoted to CRM system implementation, to quickly get a competitive advantage. It will need to increase the project budget, or the objective to be reduced.

If CRM project budget decreases, the project manager will need more time to complete his project, or it will require a reduction in project objectives.

The budget allocated to a CRM project can be reduced for various reasons: either reflects the worsened financial situation of the company or the manager decides to release some of the staff on CRM tasks and transfer them to a specialized contact center.

### **3. The four rules of a CRM approach by the companies**

There aren't just a few the cases where managers say they are overloaded with information. Performing managers are those who report only what is essential and quickly find the information they need for decision making.

Below we present four rules that should be applied by companies for having success in the information age [4]:

1. Information should be presented as more attractive.

New media, particularly the Internet, can meet the needs of knowledge and information of customers. Accessing information must be made quickly. The easiest way to present the information as attractive is creating a website for the presentation of products and services. When access to such a site is simple and it is associated with various attractions (eg promotional prices for those buying online), the customer repays this by returning to a subsequent navigation to this site and by loyalty. In addition, this customer will share positive information about the site to its reference group.

Attractiveness is now and will always remain an important quality, in order to enhance the capacity for acceptance of goods or services by customers.

2. Companies should always be ready to solve customer problems.

This rule is actually an important principle of CRM. Clients look to online media because they can buy at any time; they will also be pleased if they receive assistance in using purchased products when they wish. Complaints regarding some products purchased can be resolved at any time in case of online connections between client and supplier.

3. The contact with customers should be maintained in long-term.

In the relationship marketing the strategies must be correlated with the stages of the customer lifecycle. Through informatic networks, close links with customers are developing and companies must be prepared to quickly process the orders and to process thousands of transactions within a very short time. This is possible thanks to new information technologies.

4. Companies must focus their attention on customers who contribute the most to the turnover, but must not neglect the less important customers in this regard.

Knowing the facilities offered by new information technologies, customers want a personalised "treatment" from companies. A question that any manager should ponder is: "How can he develop the business in the future by the value of the contribution of its customers?". One possible answer is trying to find some obvious factors [5]:

- a. a loyal customer is a customer who frequently purchase products or services from the same bidder;
- b. not all customers are equal in their value;
- c. there is a balanced ratio between satisfaction and profitability of a client;

A CRM strategy covers all stages of the customer lifecycle:

- attracting new customers to expand the customer database;
- providing to existing customers services specially designed for them;
- capitalization existing customers, causing them to become loyal.

### **4. CRM to SCRM Evolution**

We all hear about this SCRM. It is certainly a hot topic. Here are some

important points to consider when we think about SCRM.

- SCRM is primarily a strategy that is often sustained by various tools and technologies, strategy that rely on engagement and interactions with the customer.
- SCRM is also a CRM, but more evolved, meaning a back-end process and a system for managing customer relations and data in an efficient central processor.
- SCRM will mean different things to different companies. The key is to be able to understand first the business challenges that we are trying to solve, and then to solve them.
- SCRM is a business development component, both internally and externally.

#### *Understanding CRM*

CRM consists of functions based on sales, marketing and service / support, whose purpose was to lead the way for the client to ensure he returns to buy more.

Traditional CRM was very much based on data and information on which brands might collect from their customers, all of which are entered into a CRM system that allowed then the company to target customers better.

The PR now has a very active role in SCRM (in fact, usually, PR has the initiative authority before any other department). In most companies, PR departments manage the social presence of brands and the customer engagement.

Evolution consists, in the first phase, in that the support and experience are essential components of SCRM, which revolves around the customer. But between the customer and the CRM is actually no collaborative relationship..

In SCRM, this has changed completely. The customer is in fact the focal point of the operation of a business. Instead of marketing or dispatching messages to customers, brands speak now and works with clients to solve business problems, encourages customers to form their own experiences and to build relationships with them, for which the company will support its customers.

It is very important to keep in mind that SCRM is not a new system that replaces

CRM, is simply an evolution of what always was CRM.

The challenge now is for a company to adapt and evolve to meet these new social customer needs and requirements. Unfortunately, many companies still do not understand the CRM value of Social Media.

#### **5. Conclusion**

An undeniable aspect is the crucial role that effective management of customer relationships has regarding the sustainable development of the company. One of the most relevant arguments that support managers and business interest for CRM is that the 5% reduction in the number of customers lost by the company may result in an increase of 25% to 85% of its profit.

The benefits of using CRM for the companies are: increased fidelity; decreasing procurement costs; more profit from existing customers.

However, there is a CRM insight which is strictly focused on information technology.

In a CRM implementation strategy, information technology plays a fundamental role in order to maximize profitability through a fine segmentation of the market. We are in the information technology era, involving a close link between a company and its customers, due to the emergence of databases, integrated computer systems, data warehouses, convenience of the Internet, etc. All these technologies leads to an increase of share and of customer profitability.

Information technology assists various management processes of data and knowledges, aimed at understanding customer needs, so the most effective CRM strategies can be adopted. In addition, use of information technology makes it possible to collect data needed to determine profitability and to maintain customer acquisition.

#### **6. References**

- [1] [www.crmlearning.com/ecrm-models.html](http://www.crmlearning.com/ecrm-models.html)
- [2] R. Nistor, C. Nistor, A. Capatina – “Metodologii manageriale informatice”, Ed. Academica, Galati, 2003
- [3] B. Gates – „Afaceri cu viteza gândului”, Ed. Amaltea, București, 2001
- [4] R. Nistor, A. Capatina – “Sisteme informatice de marketing”, Ed. Academica, Galati, 2004



- [5] C. Allard – Management de la Valeur Client,  
Ed. Dunod, Paris, 2003

## WEB 2.0 as a Customer Relationship Management Application - Specific Commercial Platform

Nițu Oana

*Faculty of Economics, "Ovidius" University, Constanta, Romania*

[oana.oprisan@yahoo.com](mailto:oana.oprisan@yahoo.com)

Nițu Claudiu Valentin

*Faculty of touristic and commercial management,  
„Dimitrie Cantemir” University, Bucharest, Romania*

[valynitu@gmail.com](mailto:valynitu@gmail.com)

Tileagă Cosmin

*Faculty of Economics, "Lucian Blaga" University, Sibiu, Romania*

[cosmin.tileaga@yahoo.com](mailto:cosmin.tileaga@yahoo.com)

### Abstract

*Web 2.0 commercial platform is a platform specific to CRM applications. The new web services allow users to combine real-life activities with the support of the Web. Web 2.0 principles and services promotes the idea according to which we can provide the users free services. In this paper it is highlighted the connection between Web 2.0 - CRM - Companies, link that can help the organizations to better organize and manage the customer relationships.*

**Keywords:** Web 2.0, CRM, companies

**JEL Classification:** M1, M2, M3

### 1.Introduction

The new web services allow users to combine real-life activities with the support of the Web. User-centric services are changing the way people use the Internet and influence how they organize their lives. Currently, young people form the majority of Internet users and they all define the directions the Internet will take as more and more will enter the job market and will begin to occupy decision-making positions. Their expectations, attitudes and familiarity with the Web world will give in the future the environment format, both in companies and markets that they serve.

Already many new web companies, "smart innovators" as the analysts from Arthur D. Little called them in order to distinguish them from the dominant web

companies ("incumbent") Google, Yahoo and Microsoft, threaten the industries in the "real world" with their own communication services and social communities [1]:

1. *VoIP - August 2003* - Skype launches its popular VoIP PC client that allows calls between PCs, the PCs / mobile and mobile to mobile. In 2006, nearly 7 million registered users are online every day.
2. *Communities - July 2003* - MySpace is launching its social communities site, today reaching 116 million registered users (September 2006) and around 52 million unique visitors per month. In July 2005 it is bought by News Corp. to 580 mil. USD in cash. The site occupies 8th place in the top 10 most recognized brands site in April 2006.
3. *Pictures - February 2004* - Flickr launches its publishing / share photos website. In two years Flickr has reached about 4.5 million registered users and 17 million unique users per month. In 2005 Yahoo bought Flickr with 22 million USD. On the site are stored more than 70 million indexed pictures, making it one of the most popular Internet service at that time.
4. *Video - February 2005* - YouTube launches the publishing / share website for video files. In 1.5 years reaches about 0.5 million registered users, 20 million unique visitors per month and 100 million video files stored on site. YouTube currently has

over 100 mil. posts per day, and 60% market share of all videos watched online in the US content. Simplicity of use is the key: 110 supported video formats and no registration needed to view the videos. In October 2006, YouTube was acquired by Google in a deal of 1.3 bln. Euro in shares.

Mobile terminals continue to have the voice as main application, but they are beginning to be used for multiple applications through Web access. In 2007, 3G terminal sales have exceeded those 2.5G in Western Europe. This indicates a growing trend of 3G terminal market share from 12% in 2005 to 90% in 2010. Between 2004 and 2005, 3G terminal penetration in Western Europe increased from 49% to 52%. The spread of multimedia terminals stimulates, in turn, the use of mobile Web services. Since Apple introduced the iPod in October 2001, it has become the main player in the portable MP3 player market. Since launching they sold more than 67 million iPods. The overall MP3s market is expected by Arthur D. Little to double in size in coming years, from 140 mln. copies sold in 2006 to 286 million in 2010. In the portable video game gadgets, the market is divided between two products: Portable Sony Playstation (PSP) and the Nintendo Dual Screen (NDS). With these, the players can connect one another via WiFi, they can play and converse in the network. WiFi function includes the ability to surf the Internet. The demand for PSP and NDS is huge: by July 2006 it had been sold over 20 mil. PSP units and 21 million NDS units.

## 2. What is Web 2.0?

A question that many ask themselves, but nobody can find him a clear answer. A search on Google returns more than 350 million results. Not too bad for a term which no one finds an exact definition. Tim O'Reilly's article is one of the core items, underlying the concepts of Web 2.0 [2].

Although not highlighted, there has been a transition from Web 1.0 to Web 2.0 and the transition depended on many factors. When the web has become commercial in the early 90s, there was an explosion of the Internet, the volume of information available on the Web taking impressive proportions. At that

time most of the pages were generally static. This period was subsequently called Web 1.0.

In the dotcom period (.com) the offered services have been diversified, appeared millions of pages with news that were updated often. CMS sites (Content Management System) have become necessary. Anyone can create their own web page or a personally designed using CMS sites, free or open source, with the possibility of free hosting. This is known as the period web1.5.

Web 2.0 is not the second version of a software or web techniques. Web 2.0 designate (vaguely) new ways to consider and to exploit the organizing possibilities of the web. According to them, the content and the information from the web is no longer offered to visitors only by the media, governments and private companies, but also by individuals linked through informal networks based on the Internet, and which is contributing and actively participating in provisioning and disseminating the information across the globe via the web. Typical examples for this new issue are so-called wikis, weblogs or simplified blogs, the portals and pictures, music, film / video and software stock exchange on the Internet like Flickr, YouTube and sites for file sharing [3].

A description of Web 2.0 might be done by the following:

- include a broader range of applications and services that use the Web as unified and organized communication platform;
- is built on an architecture that encourages the active participation of users;
- enables easy interaction between users who have the same interests;
- an experience much closer to desktop applications, with intuitive graphical interfaces, pleasant, programmable and, especially, transparent;
- has the ability to connect with each other various applications or services and to aggregate data from different sources - RSS, blogs;
- syndication - RSS and tags structures: removal of tree classifications and application of labels so that a certain thing is no longer strictly the offspring of one

another but it can be part of several categories;

- democratization and distribution of the content (users created content and freely distributed).

### **3. The links between Web 2.0 - CRM - companies**

Customer relationship management (CRM) consists of a complex system made up of methodologies, strategies, software and web applications that help a company to organize and manage customer relationships.

CRM interact with customers via the most efficient, faster and more sophisticated means of communication - the Internet. It is a solution that centralizes employees, processes and data from a company so that they can better serve customers and increase their loyalty. Information can be structured, unstructured, conversational or transactional.

At present, many companies feel that the advantage of web is that the visitors can find the answer on their own, minimizing the efforts of the company, reducing direct contact with agents and improving efficiency [4].

Since many users are confident about the concept of the Web, much of the support systems on the Internet will provide various means to communicate directly with agents, including through "chat". Most systems of web-based services will also have a feature that will allow customers to be contacted, or to contact the agents directly via phone, thus respecting the desire to provide preferred communication channel. When this feature is enabled in an integrated system, the contact center will be able to immediately identify the customer and to access the history of its interactions with companies.

The relationship between CRM and the new information technologies is not limited to a simple customized website but it extends to all company functions which are responsible for managing customer data. They created software packages and Web applications that addresses to sales forces, those planning promotional campaigns, teleoperators responsible for managing customer issues. An e-CRM strategy provides numerous web solutions, from simple email to customized Web Call Centers.

We present below the most widely used web solutions offered by e-CRM strategy [5].

#### *Customised Email*

It is the tool used by most companies to communicate with customers. On the websites of companies there is a contact button which can be accessed from a current or a potential customer. E-mail is the cheapest web solution strategies of e-CRM; also does not involve special technology; Its main disadvantage is that it does not enables a real-time customer dialog.

By accessing database information from customers, a company can send personalized e-mails to loyal customers with special offers, promotions, etc.

#### *CHAT Window / interactive dialogue*

A customer visits the company website wishing to receive an immediate answer to a problem arising from the use of the product he just purchased. Simply press the button CHAT on the company site, and on its monitor an interactive dialogue window will open. He will write his question in the box and shortly the answer to the question will be displayed, he can even communicate in real time with the employee of the company who sold the product. Companies have to have someone to provide technical assistance at any time.

#### *Forum / discussion group*

A discussion group allows participants to debate on topics that interest them directly, by centralizing their relationships and redistributing them by e-mail. In the case of e-CRM strategies, loyal customers of a brand meet electronically in a forum and discuss new products launched by the company, about their competitors offers, etc. A such example of forum is created by the company Nike through the concept "Nike Town", present on the company web site, in which those interested meet and discuss their favorite brand online.

#### *Videoconferencing*

They are rarely used in the e-CRM strategies, only to those companies that have significant financial resources.

Usually, it appeals to videoconferencing when a new product is launched; electronic

audience consists of customers who contribute significantly to the growth of turnover of the company. Products incorporating top technologies for videoconferencing are subject of e-CRM strategies.

#### *Mailing List / list of e-mail*

With the help of this web apps, standardized messages are sent to existing customers in the company's mailing list database. These messages are sent using a Mailing List Manager, which is a software that collects and distributes e-mail messages to a mailing list.

This mode of communication is more effective than sending personalized e-mails.

#### *Voice over Internet Applications / Voice Over IP*

VoIP requires special sound software technologies and processes. Accessing a link to a VOIP application will determine inserting in potential or actual customer browser a dialog box and also a voice software. Thus the customer can converse in real time with technical support person within the company. The sounds are converted into digital format, in this case the customer can track and display the discussion he had with the company responsible for the technical assistance.

#### *Internet Image Applications / Video Over IP*

Multimedia technology allows this type of applications that excites the client, which in addition to technical assistance, suggestions, indications for use, he can see the product it bought as running in reality, in general, applications Video Over IP are expensive and designed for general complex industrial products.

#### *CALL BACK Applications / Live Agent Call-back*

This kind of e-CRM solution combines web technology with the phone by clicking on Call-back button from the site of a company, a client who has some concerns about the product or service purchased may ask to be called immediately or at a specified time by a company responsible for the technical assistance. These applications arose when it has been observed the customers

desire to reintroduce the "human" element in online trading.

This "human" item practically disappeared in the early years of Internet use: firms spends considerable sums on building sites or online advertising, but they let the customers to fend for themselves in the buying process. It was the equivalent of building a hyper-market in which any sales force person was not available to provide information and assist customers in the purchasing process. So lately it has been noted an increasing number of "Live Call-back" operators (agents).

#### *Web Call Center / Multimedia Contact Center*

The most comprehensive and complete solution for managing customer relationships in information technology and in particular of web technologies is creating a Web Call Center, who has experience as the customer relationship management using IT, and it offers to companies the possibility of outsourcing the contact tasks and service for customers. In most cases it is cheaper for a company to entrust these tasks to a Web Call Center, and the people would have to manage relations with customers can receive other tasks within the company.

The main advantages of appealing to a Web Call Center services are:

- build a base of information by which a company knows customer needs, problems and suggestions. Using this information, the trading company will be able to create customized marketing strategies;
- Reduce the communication with customers;
- The schedule growth, a Web Call Center is available 7/7 days, 24/24;

After a survey of [www.Planete-client.com](http://www.Planete-client.com) portal in October 2002, 52% of CRM projects aimed at a business-to-business target, 13% a business-to-consumer target, 25% a mixed target. Customer retention remains the highest priority for 43% of firms, for 21% primary objective is the acquisition of new customers, and for 18% the most profitable customers capitalization [6].

## **4. Conclusion**

The new web services allow users to combine real-life activities with the support

of the Web. User-centric services are changing the way people use the Internet and influence how they organize their lives.

When the web has become commercial in the early 90s, there was an explosion of the Internet, the volume of information available on the Web taking impressive proportions. At that time most of the pages were generally static. This period was subsequently called Web 1.0.

Web 2.0 is not the second version of a software or web techniques. Web 2.0 designate (vaguely) new ways to consider and to exploit the organizing possibilities of the web. According to them, the content and the information from the web is no longer offered to visitors only by the media, governments and private companies, but also by individuals linked through informal networks based on the Internet.

These Web 2.0 features, combined with current CRM system, are giving rise to a new company strategies, Social CRM (SCRM). Social CRM creates a two-way interaction between the parties and offers the customers the ownership of the the conversation with the company.

SCRM gives us what we need to get a real perspective on the customer, which means an insight into the individual, an account or a combination of activities and items needed to turn an opportunity into waking up one successful business. It is based on history, using internal and external knowledge bases, but it also involves the intelligence of others.

Social CRM tools provide us the means to capture data about profiles and to create full customer experience which in turn contributes to the development of real prospects to customers, offering what is truly a customized experience for individual customers. Based on history, CRM could not do it. It could be gathered all transactional

data, but emotional and behavioral customer information on which the customer profiles and experiences maps can provide were not part of the value proposition for CRM offered before.

The strategy behind Social CRM is to be opened with the customer, to be visible to them, and give them the space and the necessary information to make intelligent decisions for themselves about how to interact with the company. By following this strategy, the company can learn from its customers because they have more freedom in interaction with society and with other clients.

Continuous interactions with customers will reduce the harm and will increase the good in the relations between companies and clients.

## 5. References

- [1] Anderson P., (2007) - *What is Web 2.0? Ideas, Technologies and Implications for Education*, in: *JISC Technology and Standards Watch*, February, pp. 1-64.
- [2] Beer D., Burrows R., (2007) - *Sociology and of and in Web 2.0: Some Initial Considerations*, in: *Sociological Research Online*, Vol. 12, No. 5, <http://www.socresonline.org.uk/12/5/17.html>, accessed December 13.
- [3] Capatina A., (2003) – *Soluții web oferite de o strategie e-CRM*, *Internet Magazin*, nr. 5/2003.
- [4] Constantinides E., Fountain S., (2008) - *Web 2.0: Conceptual Foundations and Marketing Issues*, in: *Journal of Direct, Data and Digital Marketing Practice*, Vol. 9, No. 3, pp. 231-244
- [5] O'Reilly Tim, (2005) - *What Is Web 2.0*, septembrie.
- [6] Gartner Dataquest- rezultate publicate în revista "Marketing Direct, nr.60, dec. 2002

## Competitiveness Issue in Romania

Motto:

"What can be measured can be improved."

Peter Drucker

Loredana Maria Păunescu  
Petroleum&Gas University, Ploiesti, Romania  
[loredana.paunescu@yahoo.com](mailto:loredana.paunescu@yahoo.com)

### Abstract

*Although progressed substantially in recent years, Romania has serious gaps in competitiveness relative to countries in western and central Europe.*

*The reasons for this are found lagging behind in all the elements that determine the competitive capacity.*

*All translate ultimately into low productivity, which defines competitiveness problem in Romania.*

**Key-words:** competitiveness, economic growth, economic trends, globalisation, capital.

**JEL Classification:** A, A2, A23.

### Introduction

The key factor in determining economic growth, given a full entry in a market marked by strong competitive forces, is economic competitiveness. In addition, the development of competitive economic advantages must be a constant process, taking account of European trends but also by the globalization process as a whole.[1] Therefore, increasing competitiveness should not be seen as a process of exploiting short term advantages (eg low cost of labor), but as a process of building an economic structure based on capital investment and research processes -development-innovation.

In other words, the possibility of a convergence perspective on the medium and long term should consider developing a knowledge-based economy.[2]

Sustainable economic growth and improve living standards for the population are determined by the development of economic competitiveness in the context of

global challenges (globalization of the economy, opening of international markets, rapid technological change), challenges that must be turned into opportunities for the Romanian economy.[3]

Despite progress on privatization, efficiency and financial sector regulation, companies' access to capital remains very limited.[4]The use of technology and equipment life with outdated energy-intensive drastically reduce productivity in most industries.

### Obiectives

The research started in pursuit of resources in education, referring here only to young university graduates in economics in university centers, which become engines of innovative activity and offering multiple opportunities and opportunities for professional development as a factor of stabilization local workforce and attracting highly skilled labor.[5]

### Research methods and techniques

In conducting the research were used three basic tools along with three complementary leading to a more accurate evaluation of the results. Ternary research include: piloting a questionnaire for subjects in the analyzed group, organizing and participating in focus groups and interviewing academics sites.

The questionnaire contains a set of 12 open questions that have as main objective to identify the following:

- ✓ the quality of Romanian university education;
- ✓ correlation between university curricula and labor market requirements;
- ✓ the usefulness of the subjects studied;

- ✓ self-assessment skills acquired;
- ✓ the rate of employment before or after completing undergraduate studies;
- ✓ bottlenecks in the engagement;
- ✓ concordance between the function and studies are completed / expertise;
- ✓ ways of information on job vacancies.

Respondents to this survey were 98%. The questionnaire included specific elements of differentiation of respondents, meaning that they could determine the specialization they are studying, the academic year in which the age, gender and background.

Also before the actual piloting of the questionnaire, the group of respondents explained their reason for participating in this action research. The questionnaire contains open questions, thereby finding out how thinking subjects, and their views are expressed freely.

After piloting the questionnaire were held focus groups with students and masters from the Faculty of Economics. Subjects have been introduced to organize the work, to obtain quality data on their views on the Romanian education system and acquiring the skills of academic labor market after graduation.

The duration of a focus group was 30 minutes for each question respondents having from 5 minutes to provide a response.

Focus - group contained the six questions that were geared towards:

- utility of theoretical knowledge acquired during the studies academic labor market insertion;
- the importance of financial self-support;
- hypothesis that subjects should respect the expertise they will hold office;
- degree of willingness to retrain according to new requirements of the labor market;
- subjective expectations about future job;
- presentation bottlenecks that have faced when trying to find a job.

Subjects could have offered anecdotal specific content elements as respondents, field of study and specialization, age, gender and background.

Research ternary ended interviewing academics. Every teacher interviewed was handed a sheet containing five questions.

Interview duration was 30 minutes for each question respondents having available 5 minutes. The questions focused on the following areas:

- mention of the criteria on which they take students / master students in choosing a particular field of study;
- vision consistency students / MA in terms of improving skills;
- expectations on graduates entering the labor market;
- level of education;
- counseling in finding a suitable job.

### Authors' contributions

In research conducted, the author has used several analysis tools that had a major impact on research results. After piloting the questionnaire and data interpretation have arisen following:

To the question "After graduation diploma/ masters have successfully employed the labor market?" Frequency response is illustrated in figures 1:

Figures 1. Frequency response

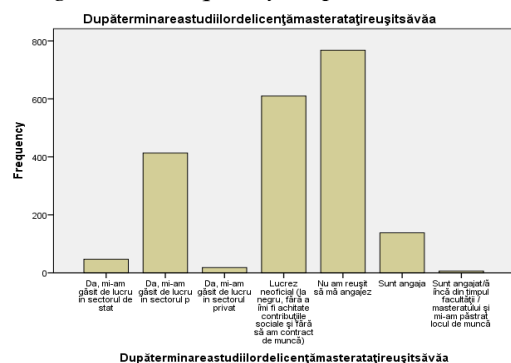

Source: author

Another question the subjects was: "For those who have employee status, how quickly you find a job?" To which the frequency response was:



Figures 2. Frequency response

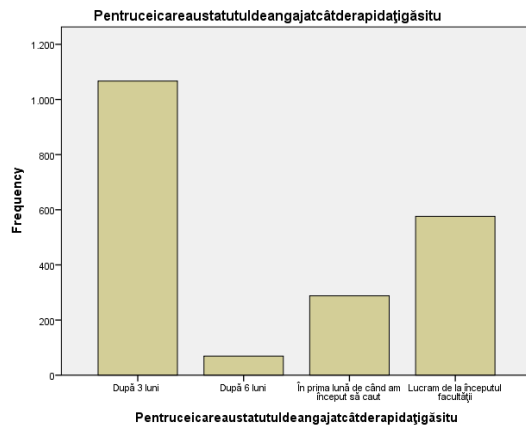

Sorce: author

Another question was the following subjects: "For those who have the status of employee you hired a function .....?" The frequency of responses to this question is presented in figures 3:

Figures 3. The frequency of responses

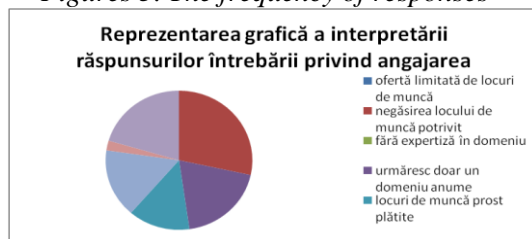

Sorce: author

## Conclusions

Following the analysis made can outline the following: economic competitiveness is determined by:

- involving urban centers in using creative and innovative national potential, to form a hierarchic system of poles/development areas by focusing combinations of competitive products and services or have chances to become competitive (IT services, financial and creative industries, environmental services, personalized services, tourism etc.) while developing accessibility of resources in education and research and innovation, business infrastructure, environmental quality and quality life;

- accessibility achieve an integrated national potential and establishing interconnections between elements polycentric system;

- using research and innovation potential, especially university centers, which become engines of innovative activity and provides multiple opportunities for professional development and opportunities to stabilize the local workforce and attracting highly skilled labor;

- development and promotion of tourism in natural and cultural heritage and perspective focused on natural and cultural landscape. However, tourism development will follow the national spatial plan (travel section) with targeting the creative management of natural landscapes and cultural heritage areas;

- making connections at the local level by stimulating the emergence and strengthening of economic clusters.

Territorial cohesion determined, long-term balanced economic development and rising living standards.[6] In the medium term, a policy oriented exclusively towards balancing the spatial economically, would lead to weakening strong zones and, therefore, it is necessary to evaluate, select and prioritize investment choices given the mix / optimal mix of competitive activities, the existence of facilities and services necessary for the operation of the development poles, checking accessibility,[7]existing human resources training facilities offer space / land necessary for their functional and compatibility.

## References

- [1] Kearns, P., *HR Strategy, Creating Bussiness Strategy With Human Capital*, USA: Butterworth – Heinnean, 2010;
- [2] Rothwell, W. J., Lindholm J.,Yarrish K. K., Zaballero A., Ed. by William Rothwell , *Encyclopedia of Human Resource Management, Human Resources and Employment Forms*, , San Francisco: John Wiley & Sons, 2012;
- [3] Dobre, M.H., Aceleanu, M.I., Negoitei, I., *Rolul educației în inserția tinerilor pe piața muncii. Cazul României*, în Angelescu, C., Ailenei, D., Dachin Anca (coord.), *România în Uniunea Europeană. Calitatea integrării*, Facultatea de Economie, 2006;
- [4] Lawler, E. E. , Boudreau J. W. , *Effective Human Resource Management, A Global Analysis*, , Stanford University Press, Stanford California, 2010;
- [5] Ehnert, Ina (Dr.), *Sustainable HumanResource Management: A*

*Conceptual and Exploratory Analysis from a Paradox Perspective*, Germany: University of Bremen, 2009;

- [6] Jackson, S. E., Ones D. S., Dilchert S. (Ed.) *Managing Human Resources for Environmental Sustainability*, The Professional Practice Series, 2012;
- [7] Jackson S E., Schuler R. S., Werner S., *Managing Human Resources*, USA: Cengage Learning, 2012.

# The Role of the Forecast in the Company's Management

Raluca Podasca

Petroleum-Gas University of Ploiesti

[raluca.podasca@yahoo.com](mailto:raluca.podasca@yahoo.com)

## Abstract

*The changes occurring in various areas of society caused a permanent research for the specialists in various fields in order to anticipate economic phenomena. Economic forecast has a fundamental role in the decision making process, primarily by reducing risk. Knowing the relative future is a modality that the company is ready to face the unexpected. Using forecasts, any manager can anticipate the future of the company, is able to appreciate the consequences of technological evolution determining methods of organizing to meet market demands. For both the manager and the company, the forecast is a necessity. The quality of the forecast determines the profitability, the economic and social growth, the entire process of renewal and changes that are required throughout the company's activity. In the last decades, there were noted important advances in the forecast activity, especially in the management process.*

**Key words:** company's management, extrapolation, forecasting methods, time series

**J.E.L. classification:** M10, C53

## 1. Introduction

The forecasting activity is essential to all economic and social activities. Under current conditions, characterized by complexity and dynamism of economic processes and phenomena, through the emergence and deepening of the financial crisis, the opportunity for companies to obtain competitive economic results depends largely on management strategies that need to be prospective. As economic activity becomes more complex and the links between the components of national economy multiply and diversify, the forecasting activities

become essential as an indispensable condition of decision making.

## 2. Fundamental stages of elaborating forecasts

Even if the forecast activity presents specific features depending on the area, the objectives and techniques used, it is noticed a harmonization of methodologies for elaborating predictions. It can delineate the stages to be completed for the elaboration of the forecasts, no matter of the field covered.

These stages are:

- identification of the forecast's subject;
- determining the time period for which the forecast is elaborated and the degree of detail in its;
- data collection and evaluation;
- choosing the prediction method (generally based on available data);
- the proper elaboration of the forecast by applying the opted method;
- choosing the specific manner of the presentation of predicted results (the choice of the most likely alternative, the presentation of results in scenarios form or confidence interval form);
- evaluation of the accuracy of the method used, by comparing the forecast with actual data, once they become available (very useful step in selecting the most appropriate method).

## 3. General consideration on time series

Values recorded over time, obtained as a result of observations made on various phenomena, are registered as time series, also called dynamic time series. A succinct definition of a time series could be a succession of values recorded sequentially in time.

Depending on the time unit of each level of the characteristic, time series can be

divided into intervals time series and time series of moments.

Intervals time series (continuous series) contain terms that reflect results achieved within a time period (year, quarter and month) considered in succession (for example, the values of turnover and profit in the period 2004-2014 of a company). These types of series are commonly found in economic publications, reflecting the economic process.

Chronological series of moments are composed of successive terms which represent the economic process followed in time (for example, the commodity stock at the beginning of each month in 2014). What characterizes the intervals time series is the possibility to summarize values (adding the monthly or quarterly sales of goods can be obtained the sales per year). The graphical representation of time series indicates the form of the phenomena's evolution. It can be a linear evolution, an exponential evolution, a polynomial evolution or a logarithmic evolution.

By analyzing the chronological evolution of an economic process it is aimed:

- the synthetic characterization of the evolution of significant indicators;
- the identification of the systematic elements that reveal laws and repeatability of the phenomenon;
- development of forecasts based on the study and past evolution of the phenomenon.[1]

#### 4. Forecasting methods based on time series analysis

Extrapolation is the most common method in quantitative forecasts, consisting in future extension of ongoing developments in the past. It is based on the fact that the causal relationships are known and in analyzed process evolution will not occur essential transformations, so the trend will not suffer important changes.

Trend calculation is based on the actual values adjustment of statistical series, replacing real terms values obtained through different models.[2] There are two types of extrapolation based on time series:

-mechanical extrapolation when admitting that the relationship between variables will not change in the future and therefore

proceeding to an automatic extension of the trend in the past;

- heuristic extrapolation, when starting from the analysis of the previous period, there are introduced some corrections (correction coefficient of the trend) in trend phenomenon, depending on expected changes or some options of decision makers.

Although it is a quite fast and easy method to apply, extrapolation presents some disadvantages:

-can be used successfully only for economic processes that maintain the direction and intensity of evolution;

-provides only an indicative overview perspective, because the future does not entirely reproduce the past evolution;

-as much as the forecasting horizon is getting further, increase the share of risk factors and uncertainties, which generates the possibility of changing the trajectories of the past, so it is preferred that method to be used for as short as possible periods.[3]

Extrapolation methods based on time series are divided into:

-extrapolation based on average gain;

-extrapolation based on average index.

Extrapolation based on average gain is used if economic processes evolve as an arithmetic progression (absolute changes with chain base are approximately constant).

Trend is calculated according to the following relationship:

$$\hat{y}_t = y_0 + t \cdot \bar{\Delta}$$

where:

$\hat{y}_t$ - adjusted variable for the analysis period;

$y_0$ -the value of the variable in the base period;

$t$ - number of years (or other time units) from the period of trend calculation

-average gain.

Forecasted values will be calculated as:

$$\hat{y}_{n+p} = y_n + p \cdot \bar{\Delta}$$

where:

$\hat{y}_{n+p}$ - extrapolated variable for the forecast horizon;

$y_n$ - value of the variable in the last year;

$p$ - number of years (or other units of time).

Heuristic extrapolation takes into account a correction coefficient ( $k$ ) which indicates the experts' estimations relating to the evolution of the analyzed phenomenon.[4]

Thus, the calculation equation is:

$$\hat{y}_{n+p} = y_n + p \cdot k \cdot \bar{\Delta}$$

where:

k- correction coefficient, which can be greater than 1, emphasizing the trend, or smaller than 1, decreasing the trend.

Extrapolation based on average index applies to economic phenomena and processes evolving in form of geometric progressions (the dynamic indices chain based are approximately equally).

The equation for mechanical extrapolation is:

$$\hat{y}_{n+p} = y_n \cdot \bar{I}^p$$

The calculation formula for heuristic extrapolation is:

$$\hat{y}_{n+p} = y_n \cdot \bar{I}^p \cdot k$$

### 5. The forecasting of the economic indicators of a pharmaceutical company

Antibiotice SA is the leading Romanian producer of generic anti-infective medicines. Its mission is to transform valuable treatments in a more accessible way to improve the quality of people's lives. The portfolio of 148 drugs covers a broad range of therapeutic areas. The product development strategy is focused today on medicines from the following classes: cardiovascular, infectious and central nervous system. Antibiotice SA is one of the most important Romanian exporters of medicines in finished form and Nystatin (active substance). A priority in the company's strategy is the business development markets on European Community, USA, Russia and North Africa.

Among the company's competitive advantages there are:

- it has 70 product registered for export portfolio;
- it has 120 business partners throughout the world;
- it is the world leading manufacturer of Nystatin;
- it has international quality certifications: FDA (Food and Drug Administration) and CoS (Certificate of conformity issued by the European Directorate for the Quality of Medicines);

- it has a modern research and development center that achieves complete documentation for obtaining marketing authorization for medicinal studies. [5]

Table 1. The economic indicators of Antibiotice SA

Year	Turnover (million RON)	Profit (million RON)	Number of employees (persons)
2009	219.75	15.64	1430
2010	243.62	18.47	1441
2011	281.84	26.39	1450
2012	304.73	34.45	1465
2013	318.62	34.69	1465
2014	320.05	31.13	1465

Source: Ministry of Public Finance [6]

Figure 1. The evolution of turnover between 2009 and 2014

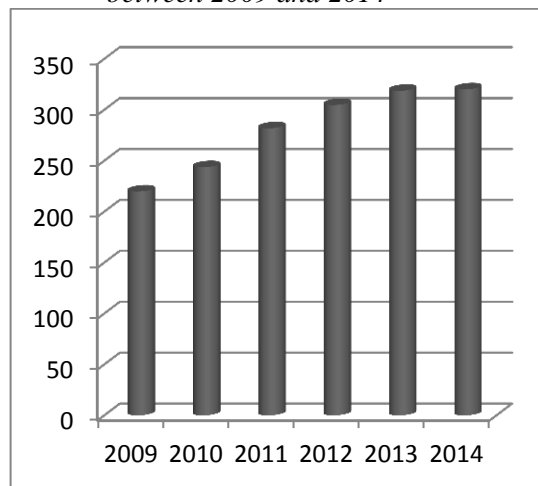

Source: made by the author

Studying the figure above, it is noted that between 2009 and 2014, the turnover had a linear evolution, so it can be used as a trend determination method the average growth method and as a forecast method the extrapolation based on average gain.

$$\bar{\Delta} = \frac{320.05 - 219.75}{5} \Rightarrow \bar{\Delta} = 20.06 \text{ mil. Ron/ year}$$

The previously obtained value indicates that turnover has increased an average of 20.06 million Ron/year in 2009-2014.

The adjusted values are:

$$\hat{y}_{2009} = 219.75 + 0 \cdot 20.06 \Rightarrow \hat{y}_{2009} = 219.75$$

$$\begin{aligned} \hat{y}_{2010} &= 219.75 + 1 \cdot 20.06 \Rightarrow \hat{y}_{2010} = 239.81 \\ \hat{y}_{2011} &= 219.75 + 2 \cdot 20.06 \Rightarrow \hat{y}_{2011} = 259.87 \\ \hat{y}_{2012} &= 219.75 + 3 \cdot 20.06 \Rightarrow \hat{y}_{2012} = 279.93 \\ \hat{y}_{2013} &= 219.75 + 4 \cdot 20.06 \Rightarrow \hat{y}_{2013} = 299.99 \\ \hat{y}_{2014} &= 219.75 + 5 \cdot 20.06 \Rightarrow \hat{y}_{2014} = 320.05 \\ \text{The predicted values of the turnover are:} \\ \hat{y}_{2015} &= 320.05 + 1 \cdot 20.06 \Rightarrow \hat{y}_{2015} = 340.11 \\ \hat{y}_{2016} &= 320.05 + 2 \cdot 20.06 \Rightarrow \hat{y}_{2016} = 360.17 \\ \hat{y}_{2017} &= 320.05 + 3 \cdot 20.06 \Rightarrow \hat{y}_{2017} = 380.23 \\ \hat{y}_{2018} &= 320.05 + 4 \cdot 20.06 \Rightarrow \hat{y}_{2018} = 400.29 \end{aligned}$$

$$\hat{y}_{2018} = 31.13 + 4 \cdot 3.098 \Rightarrow \hat{y}_{2015} = 43.522$$

## 6. Conclusions

Because of the recent events in the global economy, more and more specialists believe that it is necessary questioning the old economic and management practices. Company's management should pay more attention to the forecasting and planning methods. The time and effort allocated should be significantly higher because a forecast cannot afford to have only one scenario, various alternative plans are necessary. In turbulent times, a wrong forecasting of planning can make the difference between profit and loss, not between a higher or lower profit, as was the case in situations of economic growth. Moreover, it is necessary to pass from an inside-out approach of predicting and planning to an outside-in approach in which the primary role should not be the manager's subjective expectations or comparison with company's earlier performances, but the market evolution and changing customer expectations.

Figure 2. The evolution of profit between 2009 and 2014

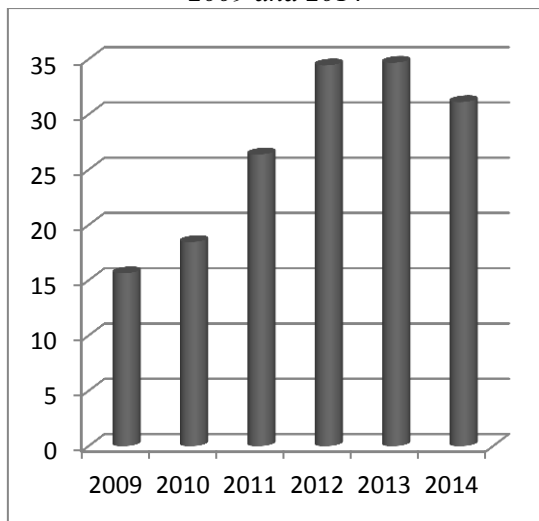

Source: made by the author

Studying the figure above it is noted that profit increased between 2009 and 2013 while in 2014 decreased.

$$\bar{\Delta} = \frac{31.13 - 15.64}{5} \Rightarrow \bar{\Delta} = 3.098 \text{ mil. ron/year.}$$

The previously obtained value indicates that profit has increased an average of 3.098 million Ron/year between 2009 and 2014. The adjusted values are:

$$\begin{aligned} \hat{y}_{2009} &= 15.64 + 0 \cdot 3.098 \Rightarrow \hat{y}_{2009} = 15.64 \\ \hat{y}_{2010} &= 15.64 + 1 \cdot 3.098 \Rightarrow \hat{y}_{2010} = 18.738 \\ \hat{y}_{2011} &= 15.64 + 2 \cdot 3.098 \Rightarrow \hat{y}_{2011} = 21.836 \\ \hat{y}_{2012} &= 15.64 + 3 \cdot 3.098 \Rightarrow \hat{y}_{2012} = 24.934 \\ \hat{y}_{2013} &= 15.64 + 4 \cdot 3.098 \Rightarrow \hat{y}_{2013} = 28.032 \\ \hat{y}_{2014} &= 15.64 + 5 \cdot 3.098 \Rightarrow \hat{y}_{2014} = 31.13 \end{aligned}$$

The predicted values of the profit are:

$$\begin{aligned} \hat{y}_{2015} &= 31.13 + 1 \cdot 3.098 \Rightarrow \hat{y}_{2015} = 34.228 \\ \hat{y}_{2016} &= 31.13 + 2 \cdot 3.098 \Rightarrow \hat{y}_{2016} = 37.326 \\ \hat{y}_{2017} &= 31.13 + 3 \cdot 3.098 \Rightarrow \hat{y}_{2017} = 40.424 \end{aligned}$$

## 7. References

- [1]Lazăr, C., Lazăr, M., *Methods and Techniques of Economic Forecasting*, Corint Publishing House, Bucharest, 2009.
- [2]Țițan, E., Ghiță, S., Trândaș, C. *Statistics Basics*, Meteora Press Publishing House, Bucharest, 2000.
- [3]Nicolae, V., Constantin, D., Grădinaru, I., *Forecasting and Economic Orientation*, Economic Publishing House, Bucharest, 1998.
- [4]Caracotă, C. R., Caracotă, D., *Development Strategy. Economic Forecasting*, University Publishing House, Bucharest, 2007.
- [5][www.antibiotice.ro](http://www.antibiotice.ro)
- [6]Ministry of Public Finance, <http://www.mfinante.ro/infocodfiscal.html>.

# Cobb-Douglas Model Used in the Analysis of Enterprise's Performance

Raluca Podasca

*Petroleum-Gas University of Ploiesti*

[raluca.podasca@yahoo.com](mailto:raluca.podasca@yahoo.com)

## Abstract

*Accelerating changes affecting products, processes, markets, technologies and business sectors have resulted to the necessity of obtaining high levels of enterprise's performance not only to be competitive, but to survive in an increasingly dynamic environment. The research aims to analyze the economic performance of the enterprise by applying the complex model of economic growth at microeconomic level. It analyzes the evolution of an economic phenomenon in terms of size, structure, of its interdependencies and change over time and the factors that influence its evolution.*

**Key words:** Cobb-Douglas model, enterprise's performance, competitiveness

**J.E.L. classification:** M10, M21

## 1. Introduction

Given the intensification of competition, it is necessary an approach of the enterprise performance in the context of the new features of the environment in which is integrated the company.

Modern industrial company operates in an extremely dynamic and turbulent environment, characterized by the following defining aspects:

-amplification of the competition by increasing the number of competitors employed in the same activity sector and their level of competitiveness in terms of mutation produced in the factor structure;

-the emphasizing process of decentralization of large industrial companies due to their concerns for reducing the complexity of management, increasing flexibility and responsiveness to the requests of the competitive environment;

-globalization of the economy and markets, increased mergers and acquisitions,

increasing number of agreements and strategic alliances as key factors of competitiveness;

-customizing needs, preferences and wishes expressed by customers in terms of demand frontload product offering which increases the share of individual production based on differentiated products;

-the amplification of customers' requirements which gain new meanings in terms of quality, variety, diversification and trade facilitation sale services that accompany the product offer.

## 2. General considerations on the concept of enterprise

The enterprise is the basic organizational unit of the economy which holds a complex technical-productive, economic, organizational, administrative and social activity. The enterprise has as object of activity the production of goods, the execution of works or services. [1]

Enterprises are found in all fields of industry, agriculture, construction, transport, commerce, telecommunication, having as main objective the obtaining of profit.

Enterprise systemic approach highlights several defining features as follows:

-enterprise is an open system as it interacts with other systems flows through inputs as raw materials, fuel, equipment, funds, information and outflows of finished and semi-finished products, goods, funds, information etc.;

-enterprise is a complex system that combines human, material, financial and information resources, each of which consists of a variety of specific elements among which are established multiple

links; their combination create other subsystems;

-enterprise constitutes a socio-economic system, the place of combining inputs in the production processes, aiming to create new values, according to market demands;

-enterprise is an administrative organization which is explained by the fact that since its foundation receives the status of a legal entity;

-enterprise constitutes an economic-cybernetic system similar to biological organism; enterprise system functionality and efficiency depend on the way in which inflows are transformed into output streams, these transformations being governed by economic optimum criterion.

In the national economy, enterprises provide an economic and social role.

Economic role of enterprises is materialized in the fact that they attract and combine production factors with the purpose of obtaining goods, works and services at low costs. Also, the enterprise distributes the revenue according to specific actions for the remuneration of production factors as: salaries- personnel employed, taxes and fees- state, social contributions- social services, interest and commissions- banks and other lending institutions, dividends- associates and shareholders, self-financing funds-company. [2]

Social role of enterprise results from the fact that it lives through individuals, employees and consumers of goods offered on the market, to which should show a specific social role. The enterprise should ensure favorable working conditions and proper wages for employees, the best adaptation of goods and services according to market demands for consumers.

### 3. The Cobb-Douglas model

Production functions were introduced in the economic literature in 1894 by the economist Wicksteed and were applied for

the first time, by P. Douglas and C. W. Cobb. After 1961, the model began to diversify when K.J. Arrow, H.B. Chenery, B.S. Minhas and R. M. Solow proposed for the shaping of US economy the Constant Elasticity of Substitution function. Production functions are functionally expressed by the link between the result of a productive activity (gross domestic product, added value etc.) and the factors that determine it (work seen as volume, structure and productivity, volume and efficient use of capital, technical progress etc.)

The Cobb-Douglas model proposes the definition of  $f$  function which represents the analyzed phenomenon. I considered  $f$  variable as net turnover which depends on independent variables  $x, y, z, u$  defined by the Cobb-Douglas function as production factors:

$$f(x, y, z, u) = A \cdot x^\alpha \cdot y^\beta \cdot z^\gamma \cdot u^\delta \quad (1)$$

where:

$f$ - the modeled economic indicator;

$x, y, z, u$ - the production factors;

$A$ - the proportionality factor which expresses the effectiveness of the factors  $x, y, z, u$  in their joint action;

$\alpha, \beta, \gamma, \delta$ - elasticity coefficients expressing the variation of the analyzed indicator reported to the elected factors.

Determination of real constants  $A, \alpha, \beta, \gamma, \delta$  obtain the logarithms of relation (1) to give its new form:

$$\ln f = \ln A + \alpha \cdot \ln x + \beta \cdot \ln y + \gamma \cdot \ln z + \delta \cdot \ln u \quad (2)$$

Equation (2) has become a linear relation in logarithms. It lends itself to linear regression applied to the analyzed phenomenon and its factors for the periods studied allowing the coefficient determination. [3]

If we denote  $\ln f = F, \ln A = a, \ln x = X, \ln y = Y, \ln z = Z, \ln u = U$  equation (2) becomes:

$$F = a + \alpha \cdot X + \beta \cdot Y + \gamma \cdot Z + \delta \cdot U \quad (3)$$

If  $\alpha + \beta + \gamma + \delta > 1$  then the model has increased efficiency, allowing an extension of it. Growing  $k$  times every parameter it is obtained:

$$x \rightarrow k \cdot x; y \rightarrow k \cdot y;$$

$$z \rightarrow k \cdot z; u \rightarrow k \cdot u;$$

$$f \rightarrow k^{\alpha + \beta + \gamma + \delta} \cdot f, \text{ so an increase of } k^{\alpha + \beta + \gamma + \delta}$$

times bigger for the analyzed phenomenon, respectively net turnover.

The factors that influence net turnover within an enterprise operating in the medicines production are:  $x_i$ - operating expenses,  $y_i$ -



financial expenses,  $z_i$ - number of employees,  $u_i$ - information and communication technology expenses. There will be analyzed data of two significant enterprises that operate in the medicine production field. The data that will be used for the study are presented in the following table:

Table 1. The variable values for Antibiotice SA

Year	$f_i$	$x_i$
2006	195677945	164311849
2007	229415602	193771003
2008	215805947	201499977
2009	219754104	192566933
2010	243626062	217967691
2011	281847455	252405102
2012	304731950	266001633
Sum	1690859065	1488524188

Source: [www.bvb.ro](http://www.bvb.ro) [4]

Table 2. The variable values for Antibiotice SA

Year	$y_i$	$z_i$	$u_i$
2006	3362907	1556	883311
2007	6869401	1565	1212667
2008	16345697	1523	545382
2009	13094900	1430	473026
2010	26375620	1441	1327149
2011	23745712	1450	1200053
2012	24368301	1465	1381074
Sum	114162538	10430	7022662

Source: [www.bvb.ro](http://www.bvb.ro) [4]

The values obtained after the change of variables are centralized in the following tables:

Table 3. Processed data

Year	$F_i$	$X_i$
2006	19.09198	18.91728
2007	19.25105	19.08219
2008	19.18989	19.12130
2009	19.20802	19.07595
2010	19.31115	19.19986
2011	19.45688	19.34655
2012	19.53494	19.39901
Total	135.04390	134.14213

Source: made by the author

Table 4. Processed data

Year	$Y_i$	$Z_i$	$U_i$
2006	15.02832	7.34987	13.69143
2007	15.74259	7.35564	14.00833
2008	16.60948	7.32844	13.20924
2009	16.38773	7.26543	13.06691
2010	17.08795	7.27309	14.09854
2011	16.98291	7.27932	13.99788
2012	17.00879	7.28961	14.13837
Sum	114.84777	51.14140	96.21070

Source: made by the author

After solving the system of equations by Cramer's method, the following values are obtained:

$$a = 0.34860 \Rightarrow A = e^a = 1.41708$$

$$\alpha = 0.10367;$$

$$\beta = -0.00734;$$

$$\gamma = -0.05875;$$

$$\delta = 0.00259$$

Mathematical equation that expresses net turnover variation depending on selected factors is:

$$f(x, y, z, u) = 1.41708 \cdot x^{0.10367} \cdot y^{-0.00734} \cdot z^{-0.05875} \cdot u^{0.00259}$$

Studying the equation obtained, it is noticed that among the model's parameters, the operating expenses and ICT expenses sustain the growth of net turnover since the exponents are positive, while financial costs and the number of employees are unfavorable to growth, because their exponents are negative.

The following table presents data from the second enterprise analyzed:

Table 5. The variable values for Zentiva SA

Year	$f_i$	$x_i$
2006	242096618	253225359
2007	193996640	190573330
2008	218505848	196669965
2009	175765574	191707341
2010	259644377	198716232
2011	235648166	214649138
2012	242491029	220326105
Sum	1568148252	1465867470

Source: [www.bvb.ro](http://www.bvb.ro) [4]

Table 6. The variable values for Zentiva SA

Year	$y_i$	$z_i$	$u_i$
2006	30838086	1012	221694
2007	10658022	821	156836
2008	10528368	738	617120
2009	3983645	691	610732
2010	2044533	585	392165
2011	1938258	555	567350
2012	1483573	531	292520
Sum	61474485	4933	2858417

Source: [www.bvb.ro](http://www.bvb.ro) [4]

Using the same change of variables as in the previous example, are obtained the following results:

Table 7. Processed data

Year	$F_i$	$X_i$
2006	19.30485	19.34979
2007	19.08335	19.06555
2008	19.20232	19.09704
2009	18.98466	19.07148
2010	19.37482	19.10739
2011	19.27785	19.18452
2012	19.30648	19.21062
Total	134.53433	134.08638

Source: made by the author

Table 8. Processed data

Year	$Y_i$	$Z_i$	$U_i$
2006	17.24426	6.91968	12.30905
2007	16.18182	6.71052	11.96296
2008	16.16958	6.60394	13.33282
2009	15.19771	6.53814	13.32241
2010	14.53068	6.37161	12.87944
2011	14.47730	6.31897	13.24873
2012	14.20996	6.27476	12.58629
Sum	108.01132	45.73763	89.64170

Source: made by the author

After solving the system of equations by Cramer's method, the following values are obtained:

$$a = 8.81200 \Rightarrow A = e^a = 6714.29471$$

$$\alpha = 7.09477,$$

$$\beta = 0.63276$$

$$\gamma = -4.48004$$

$$\delta = 0.54700$$

Mathematical equation that expresses net turnover variation depending on selected factors is:

$$f(x, y, z, u) = 6714.29471 \cdot x^{7.09477} \cdot y^{0.63276} \cdot z^{-4.48004} \cdot u^{0.54700}$$

Analyzing the equation above, it is noticed that only the number of employees is unfavorable to the growth of net turnover, while operating expenses, financial expenses, information and communication technology expenses sustain its growth, having positive exponents.

#### 4. Conclusions

Dynamic and complex economic phenomena occurring at macroeconomic and microeconomic level in the current period require a thorough analysis of their trends, in order to highlight the conclusions which fundaments the management process. At microeconomic level are necessary analyzes on the performance of enterprise and comparison with its main competitors. Performance analysis helps to identify the unsatisfactory activity of the enterprise and the establishment of measures the will influence future results. Since the main objective of an enterprise is to maximize the value of the assets, the efficiency use of the capital invested is the central objective of financial diagnosis.

#### 5. References

- [1] Bojian O., *Business Accounting*, Economic Publishing House, Bucharest, 1998.
- [2] Barbulescu C., *Performant Pilotage of Enterprise*, Economic Publishing House, Bucharest, 2000.
- [3] Constantinescu C., *Features of Information Technology for Strategic Management*, Economic Publishing House, Bucharest, 2000.
- [4] Bucharest Stock Exchange <http://www.bvb.ro/>.

## Communication Style: Mirror of Individual's Behavior

Norina Popovici

„Ovidius” University, Faculty of Economic Sciences, Constanta

[norinapopovici@yahoo.com](mailto:norinapopovici@yahoo.com)

Gheorghe Moraru

“Mircea cel Batran” National College

[gheorghe.moraru@yahoo.com](mailto:gheorghe.moraru@yahoo.com)

Camelia Moraru

[cami.moraru@yahoo.com](mailto:cami.moraru@yahoo.com)

"Dimitrie Cantemir" Christian University, Constanta

### Abstract

*In order to build our own future, we must know ourselves better. To get rid of stress and feelings of helplessness, it is important to realize that the problems are not external, that others are not to blame. Each of us should aim every morning, in the mirror, to be the best version of itsown each day. We must be aware that every bad situation we are experiencing, contains an equivalent or even greater benefit.*

*"The way to be" of individuals is seen in their behavior and in their communication style. We analyzed which communication style is predominant among students of the Faculty of Economics, University "Ovidius" of Constanta, communication style that reflects their dominant behavior.*

**Key words:** communication, ego, education, behaviour

**J.E.L. classification:** D83

### 1. Introduction

Ruben, an American professor, defines communication as *"an essential life process by which animals and humans generate, acquire, transform and use information in order to carry out the work or life."*[6]

Communication is a basic element of human existence without which it would not carry on. It is acting as an intermediary between us and others, and as a mirror, perform the important control function. Communication is the exchange of information, while communication

relationship with the environment is the most important prerequisite for mental health[1].

Any attitude that we approach communicates something about us and determines, consciously or unconsciously, a response reaction from others. It can be a trigger and a constant supporter of the process of social evolution[1]

Listen, along with speech is part of the communication process. In everyday life, people listen less than 25% of the spoken messages intended. Immediately after receiving the message, a normal listener remembers only 50% of the information received, and 48 hours later working memory retains only 25% of messages received.

Active listening is that ability which demonstrate that we are interested in what other party says and offer them support and encouragement to communicate.

### 2. Transactional Analysis Ego States

Transactional Analysis is a theory of communication and human personality. Knowledge and especially understanding of the concepts and instruments that operate transactional analysis means better self-knowledge and a better understanding of others and an effective tool to improve communication[7]

The fundamental concept of transactional analysis is "ego state". A state of ego is defined as *"certain way of being, a coherent thoughts and feelings system, manifested by a corresponding pattern of behavior"*. The behavior of individuals is reflected in the way they communicate. Each state has an element of self negative and positive. The

personality of any person, psychic structure is "compressed under ego states or three ways of being: Parent, Adult and Child.

*Child ego state* responds exactly how people respond when they were children at a certain age. It is characterized by the expression of emotions, thoughts and behavior similar to childhood: the spontaneous outbreak of laughing/crying, curiosity, whining, excitement, pain or frustration.

Child ego state is divided into two components: Adapted Child (it complies with the limits imposed by society, behave "good" (+); without courage, accept unfavorable situations, just to not upset (-)) and *Free Child* (natural): spontaneous and creative (+); does only what he wants, without worrying about the others (-).

The Ego state with which people estimate objective the environment and calculates the possibilities and probabilities based on its previous experience is called the *Adult Ego state*. It manifests itself when we take real decisions and is characterized by thoughts, feelings, concrete behaviors, such as "here and now" type. When we are in this state, we do not value judgments and not relive the feelings of the past, but we are logical and reasoning to solve present problems[4]

When the Ego state is activated, people respond exactly as one of his parents did and even when the person does not openly manifest this state of ego, it acts as a *Parental Influence*, performing the functions of a conscience. We are in this state when you feel, think and act as key people around us (parents or teachers).

### 3. Transactional Analysis in "Ovidius" University of Constanta

Using the questionnaire prepared by Julie Hay, we analyzed the prevailing style of communication among the students of the Faculty of Economics, University "Ovidius" of Constanta, communication style that reflects the dominant behavior of students. This questionnaire was completed by 150 students from different years, that were attending different specialization courses.

Analysing these questionnaires, I noticed that communication styles average is allocated to an individual communication style and behavior predominantly - *Free*

*Child Ego state* - followed at a very small differences by the states of *Adult* and *Caring Parents*.

Figure 1. Questionnaire results

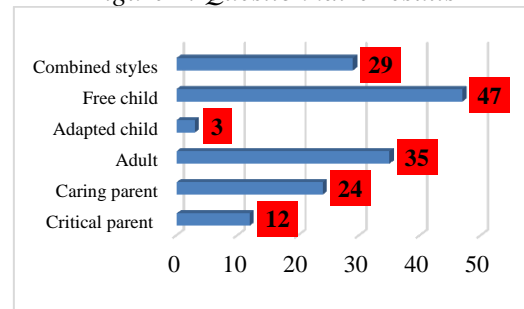

Source: according to questionnaire

The results stands out that among students prevail an amused and unstable attitude, that they are very relaxed, but also spontaneous and uninhibited, energetic and irrepressible, dominant behavior especially in the first year of college. Moreover, this type of student has the attitude of "here and now", but always with attention and concern for those around him.

Analyzing the 150 individual questionnaires, we could synthesize that only 2% of the total number of students examined have Adapted Child state as dominant Ego state. This means that 3 out of the 150 students have submissive attitude, shame, are sad, sometimes a defiant tone, but that is due to the fact that they embrace "I can not". This result seems to be an encouraging one.

12 students - which represents 8% of the total number of students - have Critical Parent state as dominant communication style. These are those students who criticize, have a bossy attitude, pointing to "guilty" and use a firm tone. They consider that "must" is a way of life and conduct their life according to "the right thing" to do.

16% of the 150 students are characterized Caring Parent approach. The 24 students are generous, understanding, caring. They have an indulgent tone, loving, offering moral support. They are always nice and kind to those around them, always smiling.

35 of 150 students presents Adult Ego State. This means that often they make decisions based on present judgments, without taking into account the previous experiences. They are always very careful and precise, with a tone indicating an interest to present and correct actions.

Figure 2. Communication styles structure

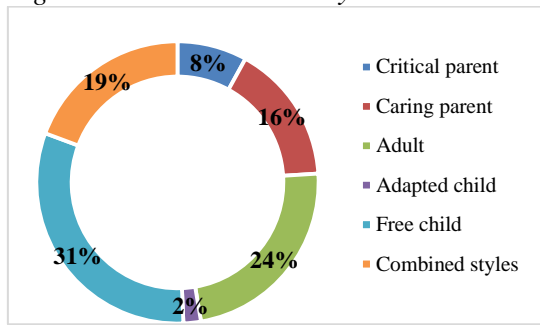

Source: according to questionnaire

24% of students were analyzed as Free child state communication style. That means that almost a quarter of total students show their genuine emotions, have an open attitude, are energetic, relaxed and curious. These 47 students who make noise, are those that teachers complain about, and express their interest in what they are passionate about.

The remaining 29 students have not described one style of dominant behavior, their ego adopting different states in different situations.

#### 4. "We are what we do"

Based on questionnaires analyzed in the previous part, we have selected five groups of 5 questions to see what motivates the students of "Ovidius" University, about the habits and self-esteem:

- the robustness with which they treat others;
- rationality in critical moments;
- obedience to others;
- compassion manifested;
- attitude to give orders.

Table 1. Correlations group 1

	Tell people exactly how to behave	Keep calm in a crisis situation	My working style is systematic and logical	People complain that I act bossy	People do what I tell them
Tell people exactly how to behave	1				
Keep calm in a crisis situation	0,013448	1			
My working style is systematic and logical	0,129364	0,29855	1		
People complain that I act bossy	0,238888	-0,07111	-0,03846	1	
People do what I tell them	0,341471	0,097471	0,097471	0,299891	1

Source: according to questionnaire

In table 1 we can see that there is some correlation between the statement "Firmly

tell people how to behave" and "People do what they say", which means that 150 students have this attitude towards others, because the environment in which they operate supports this type of behaviour. They firmly tell people how to behave because others do what they say. Instead, maintaining a calm attitude in crisis situations, systematic and logical way of working do not determinate students to be firm in the attitude they adopt.

Table 2. Correlations group 2

	I tend to think rational before I act	I like to solve problems systematically and logically	I'm not embarrassed to tell other how I feel	I ask many questions, so I'm curious	I'm appreciated for calm attitude and judicious observation
I tend to think rational before I act	1				
I like to solve problems systematically and logically	0,394265	1			
I'm not embarrassed to tell others what I feel	0,102851	0,223247	1		
I ask many questions, so I'm curious	0,01619	0,085885	0,321691	1	
I'm appreciated for calm attitude and judicious observation	0,147586	0,20356	0,059066	0,051128	1

Source: according to questionnaire

Table 2 shows that students who rationally weigh things before acting, do that because they solve problems systematically and logically. Curiosity do not lead them to act rationally, on the contrary, there is no correlation between these two statements.

Table 3. Correlations group 3

	I do what I am told to do	I enjoy being with other people	Compared to other I am too emotional	I expect my boss to tell me what I have to do and how	I easily accept what other want
I do what I am told to do	1				
I enjoy being with other people	0,005402	1			
Compared to other I am too emotional	0,227093	0,106505	1		
I expect my boss to tell me what I have to do and how	0,234262	0,042289	0,332558	1	
I easily accept what other want	0,31607	0,142317	0,341564	0,20843	1

Source: according to questionnaire

The appreciation of other for their calm attitude and judicious observations motivate them very little to think rationally before

acting.

From table 3 we can see that the students from "Ovidius" University does not accept "orders" of others due to the desire to be with other people, but because they are too emotional, too easily accept what they are told or because are waiting for indications.

Table 4. Correlations group 4

	I pity people who have problems	When I have a new colleague, I am helping him	I worry too much for other people	I stimulate people to test their own ability	I took care of people who could manage on their own
I pity people who have problems	1				
When I have a new colleague, I am helping him	0,114102	1			
I worry too much for other people	0,43949	0,23161	1		
I stimulate people to test their own ability	0,137693	0,310805	0,075029	1	
I took care of people who could manage on their own	0,243341	0,093854	0,219866	0,122298	1

Source: according to questionnaire

Caring for others leads students to feel for those around them, between these two statements there is a direct correlation, it is clear from table 4. However, when there is a new colleague that needs help, they do not try to help him, fearing that someone knows more or someone can "steel" other's place within University.

Table 5. Correlations group 5

	I tell people what to do	When I know I'm right, I insist that others listen to me	I'm very enthusiastic about my work	People say I'm creative and inventive	I prefer to take control rather than be controlled by others
I tell people what to do	1				
When I know I'm right, I insist that others listen to me	0,185351	1			
I'm very enthusiastic about my work	-0,14301	0,100468	1		
People say I'm creative and inventive	0,229581	0,133722	0,02248	1	
I prefer to take control rather than be controlled by others	0,209232	0,197852	-0,04392	0,190217	1

Source: according to questionnaire

Table 5 shows that students prefer to be the ones who take decisions and not be led by others and therefore, often, they tell people

what to do. When enthusiasm for the work they perform increases, the desire to give orders decreases and when they receive praise for their creativity and inventiveness, they feel entitled to show people "the right way".

Knowledge and self-acceptance are fundamental variables in operation and optimum adaptation to the social environment in order to maintain mental and emotional health. According to humanistic psychology developed by Carl Rogers and Abraham Maslow, each person is valuable. By human nature, people have the ability to grow and to choose their own destiny, to validate the qualities and positive attributes while the environment is able to offer them the possibility to update themselves.[3][5]

## 5. Conclusions

Things that we strongly believe have a significant impact on us. Our beliefs about ourselves, about the world, about others, about our prospects living - all our thoughts have a huge impact on human we become. The image we have about ourselves, about others and about the world around us influences behavior. There is a direct connection between communication style and the effects we have on those around us - sometimes positive, sometimes negative.

"The way to be" of individuals is seen in their behavior and in their communication style.

People hear around 1% from a conversation and 99% of what they are interested in. Many people have the impression that there is communication, but it actually does not exist. Real communication can only exist between two or more genuine people that leave masks aside and leave message to be transmitted from the essence of his being and receives other's messages into the depths of their being.

Communication is not just what we say, actually it is really far from that. What we say comes from what we are. Authentic communication is all we need. We only have express ourselves, speaking and what we say is a tiny part of this self expression.

After the study conducted at the University "Ovidius" we found out that is necessary for students to be creative and

inventive, Free child, with a positive attitude towards everything that surrounds them. The 47 of the 150 students are too few for a balanced university system. There are opinions according to which educational system, most often restricts student's manifestations as they wish. The educational system is trying to teach students how to respect some rules, rewarding notes for their intelligence, not creativity. Emotional intelligence is underdeveloped in the current educational system, and this can not lead to an excellent leader.

## 6. References

- [1] Canfield, J., Hansen, M.V., *Chicken soup for the soul*, True Publishing, Bucharest, 2012;
- [2] Garcia, H.G., *The Power of Communication*, FT Press, 2012;
- [3] Maslow, A., *A Theory of Human Motivation*, Psychological Review, 1943;
- [4] Pease, A., Pease, B., *Communication Skills*, Curtea Veche Publishing, Bucharest, 2013;
- [5] Rogers, C., *Person to Person: The Problem of Being Human*, Real People Press, 1967;
- [6] Ruben, B., *Communication and Human Behavior*, Fifth Edition, 2005;
- [7] Steele, R., *From Good to Excellent*, Curtea Veche Publishing, Bucharest, 2008.

# The Success Factors for Integrating Business Process Reengineering and Total Quality Management

Andrei Serban

*The Bucharest University of Economic Studies*

[serban.andrei8@yahoo.com](mailto:serban.andrei8@yahoo.com)

## Abstract

*In this paper the author analyze two concepts commonly used in our days in the management of organizations in Romania: total quality management (TQM) and business process reengineering (BPR). Ensuring high performance of Romanian economy and organizations is not possible without a radical change in public and private companies in Romania. With this research paper the researcher try to consolidate the ample literature on integrating BPR and TQM in companies from the private and public sector. In addition, the author determine the relevant success factors of BPR-TQM integration.*

**Key words:** Business Process Reengineering, Quality Management, integration, performance

**J.E.L. classification:** M10, M19

## 1. Introduction

Aggressive competition and globalization have led enterprises to reorganizing to focus on business processes and customer satisfaction. A wide range of new philosophies such as lean production, Lean Six Sigma, TQM and BPR have been deployed as drivers, to improve efficiency and effectiveness. This approaches have been positioned at the two extremes of a large spectrum of methodologies focused on organisational change. TQM is based on continuous improvement principles to facilitate change on a constant and progressive basis. BPR, on the other hand, assume large step changes using radical business process redesign, new organizational culture based on innovation and a fundamental rethinking of the business. Organizations can achieve significant results

by implementation of TQM and BPR.

However, there are many researches related to integration and the current use of these two process improvement methodologies.

The paper goes on to review the literature on integration of BPR and TQM in the last 20 years. It examines papers of different authors and presents the conclusion of their research. These papers demonstrate that shared usage of these approaches can lead to greater results than separate usage of TQM and BPR. Based on this research, the author find five critical succes key for implementing BPR-TQM method.

## 2. Literature Review

The elements that impose the essential managerial changes, that can be realized only through managerial reengineering, are, mainly, forms of manifestation of numerous disfunctionalities of the managements and its components. In this category, the most significant are:

- insufficient or inexistent exertion of the planning function;
- lack of an objectives system at company level layed out by processual and structural components;
- the insufficient delimitation and dimensioning of some processual components (functions, activities, competences and tasks), extremely important in realization of the objectives.
- existance of an organizatoric structure insufficiently flexible, dynamical and efficient, that would permit and incite an "aggressive" behavior of the company toward the national and international environment;
- insufficient structuring of the authority and responsibility on hierarchical levels of the



organization; (Verboncu, 2005)

To reach the goal of improving quality, organizations use different improvement tools and methods. There is no doubt that TQM and BPR are efficient strategic approaches to achieve this objective.

Quality Management is a management system focused on people whose goal is to increase customer satisfaction continue with real low cost. TQM is anchored in values that emphasize the dignity of the individual and the power of community action: it is a management philosophy and a collection of tools and strategies to implement this philosophy. (Olaru, 1999)

Total quality management (TQM) is a culture that is converted into a tool. It means, first the idea that total quality management (TQM) must be formed in the mind of every single employee and then after some time its mental concepts will be turned out into an act and are applied as an instrument for enhancing the quality of organization (Bugdol, 2005). In other words, total quality management is a method for improvement the organization and it is based on the quality and contribution of all organization members and its goal is achieving long term success through customer satisfaction and employees satisfaction (Ooi, 2007)

The goal of total quality management is to enhance customer satisfaction and organizational performance by providing high quality of products and services offered, through participation and cooperation of all stakeholders, teamwork, customer orientation and process improvement by applying the techniques and tools of quality management. (Mosadeghrad, 2014).

Business Process Reengineering is defined as the fundamental rethinking and radical redesign of business processes to achieve dramatic improvements in critical contemporary measures of performance such as cost, quality, service and speed. (Hammer and Champy, 1993)

Mlay, Zlotnikova and Watundu (2013) stated that BPR can also be defined as a total transformation of a business, an unconstrained reshaping of all business processes, technologies and management systems, as well as organizational structure and values, to achieve quantum jumps in performance through the business.

BPR attempts to bring radical rather than incremental changes and focuses on continuous improvement, consistent with the vertiginous changes that contemporary civilization experiences in social, economic, industrial and governmental areas. (Fragoso, 2015)

A number of benefits have been attributed to Business Process Reengineering: cost reduction, increases in productivity, new culture based on continuous innovation, a higher quality of goods and services offered and a simplified organizational structure.

Many factors are inherent in successful BPR. First, top management commitment is important to ensure the initiative is maintained and focused. Second, BPR focuses on providing customers with greater value: fast shipping, post-buy services, etc (Cameron and Braiden 2004). Third, reengineering places a major emphasis on employees and their role in development and realization of individual objectives. BPR can be successfully implemented in any company no matter the size, as long as the company owner has the determination for making changes and the vision for creating a new culture focused on people and innovation.

*Fig. 1. The benefits of implementation of BPR*

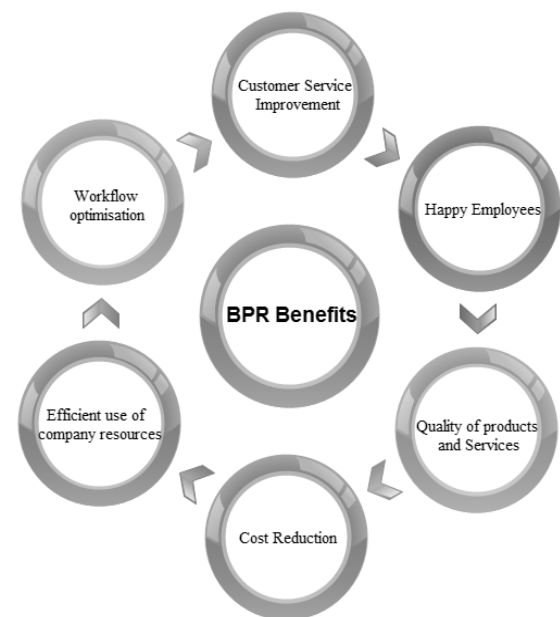

Source: made by author

It is well known that TQM focuses on customers together with emphasis on

employees, suppliers, shareholders and other stakeholders and aims to safeguard mutual wealth consequently strengthening the priority of all stakeholders. That means there must be found optimum in quality, when it does not threaten to violate the needs of other stakeholders. (Susnienė and Vanagas, 2005). The managers should also focus on the needs of customers and their satisfaction. BPR also aims at satisfying customer expectations regarding quality, cost, delivery and service, however, its approach to improvements is more radical, in a short period of time (Carpinetti, 2003)

Practical experiences in the companies where reengineering of the business processes was conducted, have shown the following: the quality was improved by 80%, time to product appearance was decreased by 75%, communication was improved by 61%, development costs were reduced by 54%, changes were reduced by 48% and profit was increased by 30%. Erić, M., Stefanović, M. (2008). Many authors, however, argue that by the simultaneous usage of TQM and BPR within one organization better results can be reached than when the TQM and BPR are used alone. Tomanek (2001) states that it is possible to integrate TQM and BPR, but it is necessary to ensure their mutual "separation". Total quality management can be implemented after the completion of radical changes resulting from the process reengineering.

Based on this knowledge, in the first part of the paper, we can conclude that the integration of BPR and TQM is possible, but further research is necessary to fully understand and create an complex methodology. In the second part of article, the author try to identify the succes factor in the aplication of BPR-TQM.

### 3. Methodology

As a first step to investigate if is possible to integrate Business Process Reengineering si Total Quality Management, the author analyzed the existent literature. We focused on literature pertaining to business process reengineering, total quality, business process change methods. We used „Business Process Reengineering“ and „Total quality management“ as the keywords for our initial search in relevand databases on internet.

Research papers were selected according to their relevance. Revelance was determined by reading the title and the abstract of each article and subsequent reading the full text of the selected papers.

Articles or books of different authors published in various reputed journals within the time span of last 20 years are selected and in depth overview is done. Each of these authors shares the opinion that it is possible to integrate and jointly use both approaches of process improvement within an organization.

After reviewing the literature and the actual situation of BPR and TQM in Romania, the author propose this framework that identifies five key criteria that affect BPR-TQM implementation: people, processes, culture, IT and resources.”

*Fig. 2. Key success factors for BPR-TQM*



Source: made by author

#### **People**

It's common knowledge that at the core of every process are people, employees of company. Hence undeless people are convinced with certain processes, those processes can never succeed. Same in the case with business process reengineering, a radical change of the organization.

As per statistics, 84% of BPR projects fail owing to some people-related issues. Far too many projects have failed in the recent past for the simple reason that some aspect of managing change was misunderstood. Training, alongside active and effective communication are some of the top factors

that have led to a successful BPR project development.

Volberda, van den Bosch and Jansen (2006) point out that technological innovation makes up only 25% of the innovation success of organizations. In contrast, social innovation, consisting of management, organization, and labor aspects, make up 75% of the ultimate innovation success of organizations.

Employees are more than the most important asset of the company – they are the source of future competitive advantage because:

-People get things done. If the company try to change his core values or try to implement a new culture, your staff will understand and replace it.

-People are adaptable. They are the most adaptable resource a company relies upon, particularly in SME's, where the resources are limited. (financial, human, tehnological)

-People have the knowledge and ideas you need. Innovation and improvement come from human resources and their insight, knowledge and experience. The employees are closest to operational problems, they know where best to cut costs, where the value really is in your business process.

-People make sacrifices. Workers can see, believe and sacrifice for the future where your customers, suppliers and executives can only see the short term.

Endowment of managerial and execution positions with competent personnel, sequence requiring a special attention by both employer and specialist on human resource management due to compatibilization of human and job through competence is also important. This implies a total synchronization between self competence (personal authority) and job competence given by professional and managerial knowledge, qualities and skills. (Verboncu, 2006)

Importance of empowerment - before a management system is established, the manager try to control all operations in small and medium companies. However, after deploying BPR, every employee in the company is appropriately empowered according to his position. While the discipline and reward pertaining to well-defined responsibilities and authorities, it stimulates employees to pursue the best

performance in the company. Focus must be on people, not business procesess.

### **Processes**

Process organization - delimitation and design of the main process components (work process) - functions, activities, group and individual tasks - assure conditions necessary to fulfill objectives. Is important to highlights basic work processes (main activities) retrieving on a process "map" which generate economic substance. Other processes are related to secondary activities which, after an economic analyze might be externalized. (Verboncu, 2009)

Processes direct teams to fulfill their objectives, such as effectively and efficiently delivering solutions according to users' needs. In an active and constantly changing environment, processes must be agile to cover these changes that are inevitable in a highly globalized market. The process should:

- Enable intra-team communication and coordination,
- Provide good visibility into progress,
- Foster productivity, creativity, and innovation,
- Beholistic and reflect the actual work done (Hussein, 2014).

### **Resources**

In this regard the correlation must be studied with relation to time. In the short term, BPR will require an investment, the size of which is directly proportional to the size of changes that are required. This investment will require financial, technological, logistical and human resources. However, once implemented BPR should assure a more efficient use of resources, less waste, less dead times in production, fast delivery. BPR should be seen as a long term investment, not as a short term cost.

Limited capital financial resources are a major constraint on BPR efforts, followed by limited managerial skills and short term strategic planning.

BPR initiatives are subject to the constraint triangle: time-cost-quality. Consequently, the BPR's project duration will depend on the cost and quality a company can or wishes to incur. BPR project should not last more than 6-8 months. One of

the main reasons the projects' duration has to be limited is change. The logic is simple: if a project expands over a longer span of time it is inevitable that the organization will change. As a result, the analysis done at the start of the project will no longer be relevant.

As BPR is still new for many organizations, managers should seek information and training on this approach by attending seminars or obtaining external consulting advice. This would help them to better understand the nature of the organizational change implied by BPR, and thus have more control over the change process itself.

### IT

Marta Fossas Olalloa (2000) in his work "Information Technology in Business Process Reengineering" have underline the importance of IT in this process. His paper has demonstrated the importance of technology in one of the most prominent methodologies. The author has concluded that companies can make their tasks easier, redesign their core processes, change the way they work and achieve spectacular improvement using this powerful tool.

In any organization, IT is the most important enabler of BPR, who aims at increase customer satisfaction, reducing cost and improving productivity. Reengineering involves radical improvements, who is impossible to achive without IT support.

Organizations from Romania use IT tools in the process of reengineering their business processes: ERP systems, CRM systems, enterprise software, cloud services, business intelligence tools, BPM software.

### Culture

After experiencing the managerial problems, a small company can entirely understand that a company can only survive in a highly competitive environment and maintain its perpetual management by continuing innovation in products, business process and people.

BPR does not work without profound cultural change as it emphasizes leadership, teamwork, empowerment, entrepreneurship, top management commitment, inovation and risk-taking.

To maintain the company's competitiveness in the market, promote an

organizational culture based on innovation is the key to ensuring success. It is very important to create an organizational culture based on innovation and decision-making freedom.

### 4. Conclusion

This research study provides an understanding on integrating business process reengineering with total quality management. The organizations most commonly use these methods to solve problems with quality and productivity. Some organizations prefer TQM, others BPR. They are generally considered as two completely different approaches of process improvement that can not be integrated. Based on this research, we can conclude that the integration is possible. Both approaches bring significant results in organizations that implement them. If organizations use the strengths of both methodologies for process improvement jointly, they could achieve more significant results as if they were used separately.

In this research we also have identified Critical Success Factors in Implementing BPR: people, processes, resources, IT and culture. Success in organizational change depends on whether the company's leadership has the determination to implement the restructuring.

Organizations use both elements of TQM, BPR and elements for increasing customer satisfaction. In most cases, organizations use items "soft" of TQM, but if necessary they use elements and "hard" reengineering. TQM can be used after a radical change through process reengineering.

### 5. References

- [1] Bugdol, M. (2005). *The implementation of the TQM philosophy in Poland*, Poland: The TQM magazine, 17(2), 113-120.
- [2] Cameron, N. and Braiden, P. (2004). *Using BPR for development of production efficiency in companies making engineered to order products*, International Journal of Production Economics, 89, 261-273.
- [3] Carpinetti, L. C. R., Buosi, T. and Gero Alamo, M. C. (2003). *Quality management and improvement. A framework and a business-process reference model*, Business Process Management Journal, Vol. 9.

- [4] Erić, M., Stefanović, M. (2008). *Comparative characteristic of TQM and reengineering*, in Quality festival 2008, International Quality Conference, Krafujevac.
- [5] Fragoso, J.T. (2015). *Business Process Reengineering in Government Agencies: Lessons from an Experience in Mexico*. Journal of Service Science and Management, 8, 382-392
- [6] Hammer M., Champy J. (1993). *Reengineering to corporation: a manifesto for business revolution*, New York: Harper Business.
- [7] Hussein, B., Hammoud M., Bazzi H. and Haj-Ali A. *PRISM-Process Reengineering Integrated Spiral Model: An Agile Approach to Business Process Reengineering (BPR)*, International Journal of Business and Management - Canadian Center of Science and Education, 9, 10, 134-142
- [8] Kurtus, R. (2000). *Using TQM and ISO 9000 in eCommerce*, Kurtus Technologies and The School for Champions, 1-4.
- [9] Mlay, V., Zlotnikova, I. and Watundu, S. (2013). *A Quantitative Analysis of Business Process Reengineering and Organizational Resistance: The Case of Uganda*, The African Journal of Information Systems: Vol. 5
- [10] Mosadeghrad, A. (2014). *Why TQM programmes fail? A pathology approach*, The TQM Journal, Vol. 26 No. 2, pp. 160-187
- [11] Olalla, M.F. (2000). *Information Technology in Business Process Reengineering*, Int'l. Advances in Econ. Res., 6(3), 581-589
- [12] Olaru, M. (1999). *Quality Management*, Bucharest: Economic Publishing House.
- [13] Ooi, K.B., Abu Bakar, N., Arumugam, V. & Vellapan, L.N (2007). *Does TQM influence employees job satisfaction? An empirical case analysis*, International journal of Quality & Reliability management, 24(1), 62-77.
- [14] Susnienė, D. and Vanagas, P. (2005). *Integration of Total Quality Management into Stakeholder Management Policy and Harmonization of their Interests*, Engineering Economics No. 4.
- [15] Tománek, J. (2001). *Reengineering a management změň: sborník článku, přednášek a studií*, Praga: Computer Press.
- [16] Ursic, D. Anteric, S. Mulej, M. (2005). *Business Process Re-engineering in Practice - A medium-sized Slovenian Company in Difficulties*, Systemic Practice and Action Research, 18,1, 89-117
- [17] Verboncu, I. (2006). *Managerial Re-engineering of the Organization*, Bulletin of Petrol-Gaze University, LVIII(2), 9-14.
- [18] Verboncu, I., Zalman, M. (2005). *Management and Performances*, Bucharest: University Economica Publishing House
- [19] Verboncu, I., E. Ceptureanu, S. Ceptureanu (2009). *Methodological contribution to organization managerial reengineering*, Brasov: Proceedings of the 4th International Conference in Business Excellence.

## 6. Acknowledgment

This work was cofinanced from the European Social Fund through Sectoral Operational Programme Human Resources Development 2007-2013, project number POSDRU 187/1.5/S/155656 „Help for doctoral researchers in economic sciences in Romania”

## Landing Pages Features to Attract Customers

Ioana Teodorescu,

*The Bucharest University of Economic Studies, Bucharest, Romania*

[ioanna.teodorescu@gmail.com](mailto:ioanna.teodorescu@gmail.com),

Viorel Vasile

*The Bucharest University of Economic Studies, Bucharest, Romania*

[viorel.vasile@yahoo.com](mailto:viorel.vasile@yahoo.com)

### Abstract

*This article aims to present and analyze the key elements of a successful landing page and how its commercial purpose can transform a visitor into a lead or customer.*

*Considering that most businesses are online, the landing page is a useful tool to influence consumer behavior and to make him act in a certain way as he reached a page.*

*We will try to discuss the psychological impact of tips and tricks when creating landing pages. There are two essential elements that can influence a visitor: the design and the copywriting of a landing page. With Internet growth, landing pages have become a good choice to create dedicated sales pages to send website visitors.*

**Key words:** landing page, Internet, customer, online

**J.E.L. classification:** M31

### 1. Introduction

In common sense a landing page is a web page where any visitor can land on. In terms of marketing and advertising, the landing page is a single web page different from the website which has been created for a specific objective to capture visitor information or for making purchasing decisions. Most often, landing pages are used as sales pages to order a product or service, but it has also the advantage to get into contact with potential clients.

### 2. Literature review

If the goal of a landing page is to collect information about the visitor, such as name, e-mail address or telephone, there are particular methods to persuade him to complete an inquiry form. The most popular ways for submitting personal data are related to get something free: subscribe to a newsletter, leave e-mail address to receive further information about products and services, download free content or trials, or just to give an opinion, feedback on a particular issue.

When the purpose is to persuade a person to complete a transaction, more specific to fulfill a shopping cart to order a product, then a landing page must draw customers' attention including specific tips: a good title, product benefits, short paragraphs and testimonials. [1]

According to online marketing there are three important steps: acquisition, conversion and retention. The first activity is connected with how visitors arrive on a website or landing page. A conversion occurs when people are guided toward a specific action on a web page. Another aspect is the retention activity which explains how businesses add value to strengthen relationships with visitors. [2]

According to specialists, a landing page design must follow the well-known formula AIDA (Attention-Interest-Desire-Action). [3] Visitors arrive on a landing page when they click on an ad, a link or other online call to action. [4]

A promising trick is to include in a landing page social media sharing buttons, because people might share it with others. [5] Another tip is the split test. This experiment can be done between two landing pages or more to which one gets more traffic. [6]

Once variants are created, the winning landing page will be the one with the highest conversion rate, although it can happen to have equal traffic as an A/B test result. There are hints presented below:

- to change the headline
- to change the place, color, shape or text of call-to-action button
- to add a video or a supporting image.

### 3. Landing page copywriting tips

The pitch to arouse the interest of a visitor on a landing page begins with the headline. It should not be forget that a potential client reaches a landing page by clicking on a link. It is very important the text in the link to be connected with the text of the headline because it may appear as an error when the message in the link is different from the headline. The headline confirms the visitor that he is in the right place and what he is about to read in the LP is related with the link he clicked. Otherwise, he surely leaves the page. The role of headline is to make the most of the unique selling proposition and to answer the big question of consumer.

A headline is followed by a subheadline that provides additional information and enforces the headline to make it look more exciting. Once a customer has read a headline that caught his attention, he immediately feels the need to know more about the subject. His first reaction will be to look down to the next line to discover the desired details. Now, he will be focused on the proper content of the landing page that concentrates on his needs. A good text responds him to little specific questions about quality, price, features, perks and assurance. [7] The ideal text to capture audience's attention is to be read with interest and fascination, paragraph after paragraph.

There are a few tips about how to write an enhancing landing page as presented in *Tabell*. First of all, the copywriter must understand himself the subject he writes about and present it in a proper manner as a selling offer. The language is better to be clear and concise and have a single focused message. It is recommended to use trust indicators such as contact details, digital signatures, testimonials for authenticity, provide a guarantee to increase visitor confidence.

Besides headline, CTA buttons are surprising elements in a landing page that develop an online business. A smart CTA button has:

- a color that is different and stands out from the background of the landing page and grabs visitor attention
- a simple design and shape
- a fitting size to click on it, if it is looking unnatural and weird, people won't click on it
- action verbs that suggest to make a decision now (*Figure1*), obvious nouns that consumers like to hear, words enabling value like "free", timing adverbs like "now" or "today". [8]

*Figure1. Action verbs in CTA buttons*

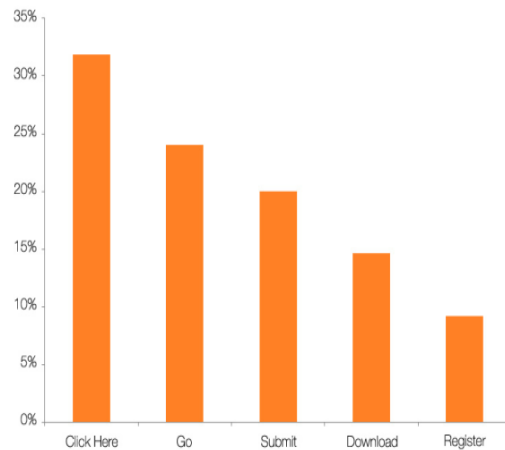

Source: Zarella, D.[9]

These psychological triggers highlight the power of emotion, because people are emotional creatures and their behavior changes according to affective stimulus. The knowledge of how consumers react when surfing the net is part of marketing tactics and their practical application increases conversion rates.

*Tabell. Key elements of a landing page*

Headline	A triggering message that captures audience attention
Subheadline	An optional explanation to the headline that convinces a visitor to read further
Body copy	The description of what is being offered with all advantages and benefits
Trust	Testimonials, security badges,

indicators	seller logos, supporting image or videos
Form/ Call-to-action button	Direct a visitor to register or to buy something, meaning to complete an action

Source: proper adaptation

Studies on the Internet reveal that consumer experiences depend on several psychological phenomena that drive and induce brain actions.

1. The deictic gaze refers to the situation when people see another person looking at something and their impulse will be to look at the same thing. This is a technique used to drive visitor attention directly to CTA (call-to-action) on a landing page using a suggestive image with someone whose glance is focused on the CTA button.
2. The primacy effect explains how people tend to remember first things they read on a webpage than what comes down. It is needed to have a promising headline, because they are more interested when they read the first lines. After a few seconds their brain will get bored to read unnecessary content.
3. The Von Restorff Effect elucidates how consumer remembers elements that stand out and are different from the rest on a landing page. [10]
4. The impact of social proof is connected to herd behavior, a psychological phenomenon when individuals gather to act collectively. This influence is created when landing page boosts credibility and trust. Positive reviews from customers will give the feeling of making the right choice. These quotes from happy clients are most commonly used in a landing page and enhance "me too" factor. [11] Social media buttons and embedded social media posts are also a great source to gain believability on landing pages. People tend to be hesitant when sharing personal information and it is recommended to design a landing page with a short paragraph regarding privacy policy and use trust seals as people feel secure seeing these elements.
5. The writing style of a landing page directly affects the whole set of brain functions as human actions depend on subjective factors. If customers are

scared of something bad that can happen or are afraid to lose something, they will do everything to prevent it, so the fear approach style or the story telling style induced in the copy body of a landing page will be evaluated as a valuable solution to their need.

6. Maslow hierarchy of needs helps to create landing pages according to emotional needs of visitors. Basic needs are related to survival so prospects become motivated when reading about product features. As it was presented above, consumers need trust and it's all around their safety needs. Except the traditional form of testimonials as social proof, a landing page can contain other trustworthy indicators: messages why is needed their e-mail address and that their personal data are not shared with other parties. When it comes to love and belonging needs, the design and text of a landing page should create the sense of community. Regarding esteem needs, it is important to focus on product benefits, not features and demonstrate prospects how products/services improve life quality to make them feel good about their purchasing decision. Self actualization is equal to conversion rate. Once a visitor felt he was treated with transparency and was given maximum attention, he is prepared to order. [12]

#### 4. Colors psychology

The colors on landing pages shape users mind and give a clue to their needs and wants. The right selection of colors in marketing influence moods and feelings of consumers and drive them to adopt a certain attitude (*Tabel2*). The psychological effect that these colors have on their visitors is a part of marketers' strategy. [13]

*Tabel2. The effect of colors on landing pages*

Color	Meaning
Yellow	It is a positive color that draws attention immediately, but it is considered to be fatiguing for the eyes. It is associated with creativity and brightness.
Blue	Blue gives the sense of dialogue and trust. It is the color of business people.



Black	This color is used to indicate luxury, exclusivity and sobriety.
Orange	Orange shows the passion for social interaction.
Pink	Pink suggests femininity and charm.
Green	Green is associated with nature and earth. It is the color of natural and organic products.
Red	This color symbolizes both the condition of winning and to pay attention at something. It is associated with thrill and is a good choice for CTA buttons.

Source: Harwood, M., Harwood, M.[14]

## 5. Conclusions

The core of creating and designing a landing page is to start with a deep knowledge about potential visitors, whether the objective is to collect data or to order goods and services. There are two perspectives to take into consideration about landing pages: one about techniques, tools and steps and the other about consumer psychology. As mentioned, landing pages focus on a single unique message. If consumer has multiple options, a choice to make becomes difficult, even impossible. The anatomy of a landing page includes a promising headline which responds to visitor big question, targeted key words, visual elements, responses to little questions in copy that a visitor would ask in his mind and a powerful CTA button. These triggers customize pages where visitors "land on" online and influence human actions as our brain is not arbitrary in front of emotions and feelings.

## 6. References

- [1] Communication Briefings, June 2015, Vol. 34 Issue 6, p3.
- [2] Ash, T., "Start Thinking About Landing Page Optimization", Promo. April 2008, Vol. 21 Issue 4, pp. 32-34.
- [3] Lander, J., "How to design an effective website landing page", *Inventors' Digest*. February 2013, Vol. 30 Issue 2, pp. 40-42.
- [4] Moran, G., "Stick the landing page", *Entrepreneur*, October 2008, Vol. 36 Issue 10, p.89.
- [5] Becker, E., Nelson, B., "Landing pages - a key to generating leads online", *Westchester*

- County Business Journal*, 12/5/2011, Vol. 47 Issue 49, p.19.
- [6] Handley, A., "Textbook landing", *Entrepreneur*, November 2011, Vol. 39 Issue 11, pp. 68-69.
- [7] Patel, N., "The 7-Step Guide to Create a Mind-Reading Landing Page", September 25, 2014, available at: <http://blog.crazyegg.com/2014/09/25/ideal-landing-page/>
- [8] Patel, N., "8 Tips to Optimize Your CTA Buttons for Conversion", July 22, 2014, available at: <http://blog.crazyegg.com/2014/07/22/call-action-buttons/>
- [9] Zarella, D., "Don't submit to landing page button text", October 8, 2010, available at: <http://blog.hubspot.com/blog/tabid/6307/bid/6737/Don-t-Submit-To-Landing-Page-Button-Text.aspx>
- [10] Fahad, M., "What is Landing Page Psychology?", September 15, 2015, available at: <https://instapage.com/blog/landing-page-psychology>
- [11] Gardner, O., "The 7 Principles of Conversion-Centered Landing Page Design", June 26, 2013, available at: <http://blog.hubspot.com/marketing/principles-of-conversion-centered-landing-page-design>
- [12] Wolf, T., "How to Create Landing Pages That Address the Emotional Needs of Prospects", January 12, 2015, in *Landing Page Optimization*, available at: <http://unbounce.com/landing-pages/landing-pages-emotional-needs/>
- [13] Fahad, M., "Ultimate Guide to Color Psychology", September 16, 2015, in *Conversation Optimization*, available at: <https://instapage.com/blog/ultimate-guide-to-color-psychology>
- [14] Harwood, M., Harwood, M., "Landing page optimization for dummies", *Wiley Publishing Inc.*, 2009

*This paper was co-financed from the European Social Fund, through the Sectorial Operational Programme Human Resources Development 2007-2013, contract POSDRU/159/1.5/S/155463 "Supporting excellence in scientific interdisciplinary doctoral research in the economic, medical and social fields", coordinator The Bucharest University of Economic Studies*

# Ship Management Benchmarking

Simona Utureanu

"Ovidius" University, Constanta, Romania  
[simona\\_utureanu@yahoo.com](mailto:simona_utureanu@yahoo.com)

Cristina Dragomir

Constanta Maritime University, Romania  
[economie.umc@gmail.com](mailto:economie.umc@gmail.com)

## Abstract

*Striving for an equilibrium consistency in the domain of ship management services, benchmarking is a useful tool for learning best practices of the best. We present in this paper our considerations regarding ship management benchmarking, taking into account the particularities of the shipping market.*

**Key words:** seafarer, ship operations, fleet management, quality and safety management  
**J.E.L. classification:** N70, O32, R4, R49

## 1. Introduction

Seas, oceans and rivers represent a huge potential for commercial activities. Water transport made by ships is by far the most efficient solution to transport large quantities of goods in terms of costs. Also, transport by water is cheaper and less polluting than road or rail transport and do not require large expenditures with investment in infrastructure for roads or railways.

There are several definitions of benchmarking, from many domains, and in this paper we will present two of them, from distinct registries. We also present our own definition and considerations regarding benchmarking applied in the case of ship management companies.

Following, we will use the widely known term "sea transport" to define any transport made by water, including transport made using ships by rivers inside continents or by oceans.

The aim of this paper is to make a step further in developing scientific knowledge in the field of ship management improvement, from a bidimensional approach (technical

and social).

The paper is based on scientific literature review, previous research studies and case-studies of world state-of-art ship management providers.

## 2. Benchmarking

Benchmarking is "a method which allows the establishment of the learning process that the organizations may pursue, in order to increase the internal activity performances". Benchmarking is different than ranking because it allows the organizations from the same environmental field to learn from one another in order to improve its organizational performance [1].

From an economic point of view, any benchmarking method includes, in general, "at least four basic elements:

- the data collection from the external organizational environment (the measurement of some variables, relevant for the organization in order to improve its performances);
- the comparison of its own data and the ones that belong to other organizations in this activity field;
- analyzing the way the better or the best performing organizations manage to attend higher performances than the ones of the reference organization;
- adopting the practices and the procedures distinctive to the better or the best performing organizations." [2]

Thijs ten Raa gives a more technical definition of benchmarking, regarded as "a function that maps two arguments, namely the object to be benchmarked - a firm, represented by the pair of its input vector and its output vector - and the backdrop against which it is benchmarked - the industry - into

a scalar, namely the efficiency of the firm. The mapping summarizes a program that identifies the best practice technologies or benchmarks for the firm. The performance of a firm will be measured by its output/input ratio or productivity - a concept that connects explicitly to the efficiency function". [3]

It is interesting to note that the term "benchmarking" is not only used in business administration or in economic sciences, as probably would be expected in general. The use of this term is spread in almost all scientific sectors. Just a few examples, among many hundreds, to support this idea, are the following works in Computer Science or in Medical Science where the term "benchmarking" is used. Wenzel-Benner and Gräf used the notion of benchmarking in a highly technical paper in Computer Science related to cryptographic algorithms with relevance for developing mobile phones, PDAs and other electronics [4]. R. Weicker wrote also a technical paper on Benchmarking and benchmarks in programming and in computers business [5]. Soelter et al. made a scientific work in neuroscience on benchmarking related to odor receptor responses [6].

Further, in this paper we present a benchmarking study on ship management.

### 3. What is ship management?

Ship management is a particular management service developed in shipping, that provides a complex management related to ships, including, inexhaustively, crew supply, technical management (monitoring the hull, engines and ship equipment), commercial management (freight management, chartering and operation) and/or insurance management.

The Baltic and International Maritime Council (BIMCO) [7], the world's largest international shipping association, with more than 2,200 members globally, providing services for shipowners, operators, managers, brokers and agents, helps lightning the notion of this term by providing several models for ship management contracts: Crewman A (cost plus Fee) 2009, Crewman B (lump sum) 2009, Layupman, Shipman 2009 and Superman.

Crewman A and Crewman B are standard crewing model contracts provided by

BIMCO for managing ship crews, as well as on shore personnel.

Layupman is the contract signed between the ship's owner and a manager, when the ship is occasionally unable to be employed due to loss of profitably; in such conditions the ship is temporarily removed from service.

In Shipman model of contracts, the Owner of the ships agrees with the ship managers/ a ship management company regarding several components of ship management: crew management, technical management of ships, commercial management (freight management, chartering and operation), insurance management, accounting services, sale or purchase of the vessel, provisions, bunkering (fueling).

Superman is a contract between ship managers or consultants and their clients to provide supervision services during the construction of a ship.

### 4. Benchmarking in ship management

Relevant works for benchmarking in ship management were done, among others, by F. Waals et al. [8], K. Mitroussi [9] and Christian et al. [10].

Considering the multidimensional approaches in defining benchmarking – some socio-economical and some technical as described in Chapter 2 of this paper, our field of expertise recommends us to point and evidence our own perception regarding benchmarking in ship management.

Benchmarking in ship management is a method of improving the business strategy of a shipping company that is striving for excellence and for the highest positive recognition on the market.

Benchmarking in ship management should be perceived from a double point of view: the point of view of the "follower company" (the company that urge for improvement and wants to reach the top) and the "leader company" (the top company, meaning the companies which already are on the highest level of recognition on the market).

We point here the observation that the general term "market", in our case, doesn't refer only to the shipping business market (i.e. the market where water transport services are commercialized). The notion of "market" is more complex and, beside

shipping companies (meaning the companies owning ships and selling transport services), it also includes industry sectors like the shipbuilding market (companies building new ships or making repairs and docking), the financial market (banks and financial institutions lending money to new investors or to ship owner companies for buying new ships or for covering expenses), the legislative environment (the International Maritime Organization and many other shipping-related governmental and non-governmental companies) and other businesses related to shipping but non-providers of sea transport service (ship management companies, crewing companies, shipchandling companies, insurance companies and P&I clubs, bunkering companies, education and training companies etc.).

Therefore, from our point of view, when considering benchmarking in ship management, benchmarking doesn't refer only in establishing the 'best of the best' practices of ship management, to be followed, as delivered by the top listed companies in ship management. Indeed, top ship management companies are able to communicate their key practices to the external environment. But it is more accurate to analyze ship management benchmarking taking into consideration the complex background of the shipping business, as well as the background of those businesses related to shipping directly or indirectly. We conclude that, in the case of benchmarking in shipping, a "follower ship management company" that strive for excellence should take into consideration not only its own internal and external business environment and top examples of its direct competitors, but it also should take into account top examples of other companies of the complex shipping market, though such companies might not be neither clients, providers or competitors. Why? Because new ideas of improvements can come from everywhere throughout the market.

## **5. How to establish benchmarking in ship management?**

There are several answers and point of views for this question.

Comparing companies in the same

business is made with the help of comparing various indexes. The flair of a researcher that has to answer such question resides in choosing the right indexes for comparison. From our point of view, is significant to compare not only the companies' turnover over the same period of time, but also there should be compared key indexes specific to the shipping sector. What kind of indexes is relevant enough for benchmarking ship management companies? From our point of view, certainly is the case of those indexes which reflect the activity of ship management, as following:

- for crew management performance: employees performance is reflected by the number of incidents on board ship; employer's motivation performance is reflected by the rate of crew drop out, etc.;

- for technical management of ships: performance of ship operations reflected by the numbers of technical breakdowns; the financial value of the technical failures; the financial value of investments in high technology; medium rate of provider's discounts;

- for commercial management: number of ships, number of clients (freighters), value of contracts, value of transported cargo; medium rate of fleet's age etc.

A complete list of key indicators in shipping is known as referring to the "Shipping KPI System", including "a standard of 64 different performance indicators (such as ship unavailability and number of environmental related deficiencies) to allow the most specific and accurate comparison of ships – within each sector and more broadly across the industry", covering: health and safety management and performance, HR management performance, environmental performance, navigational safety performance, operational performance, security performance and technical performance [11].

Also, a significant study was *Best Practice Ship Management Study* made in 2013 by Germanischer Lloyd and Fraunhofer Center for Maritime Logistics and Services [12]. The study discussed best practices on ship management, comprising "approaches, procedures, business models or tools that ship managers use to do their business smarter, safer, and greener – i.e. to be on top of competition". The study was based on data

collected from around 100 ship management companies worldwide that were analyzed regarding what they were doing to improve their operations and what they considered as being of "best practice" in the industry. The selection of the participants to the study was made in regard with the size of the company, the staff dimension and the crew pool, as shown in Figure 1 below.

Figure 1. Types of participants at the Best Practice Ship Management Study.

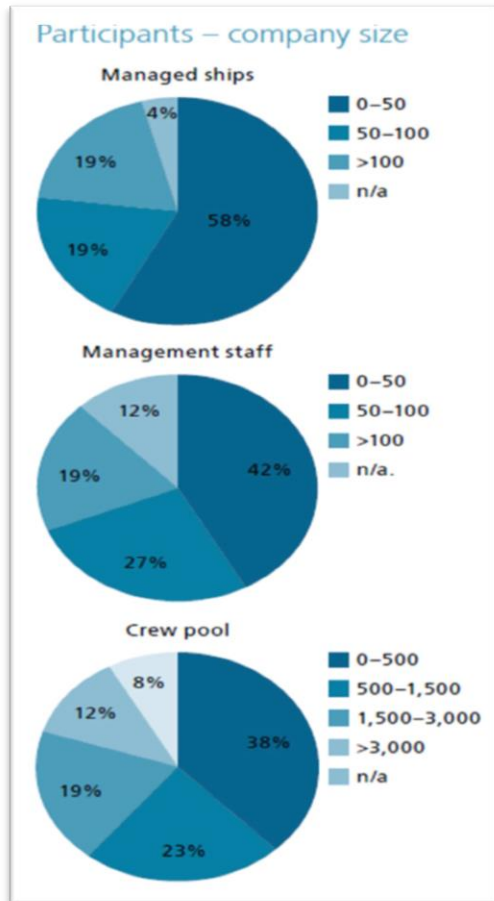

Source: [12]

According to the study, the world current situation in ship management is of increasing pressure, though today there is some slight relaxation period in the market from the 2009's sharp edge crisis period. While overcapacity in the market is driving charter rates down, ship owners face higher costs to finance vessels. Also, ship operators fight for cargo and reduce the fuel costs, meanwhile ship managers "sit in the middle with increasing burdens for the same management fees" [12].

## 6. Conclusion

Benchmarking is a term met not only in

economic sciences, as widely known, but also in other scientific domains. Benchmarking ship management companies involves establishing "the best of the best" companies that have the role of trend-setters for the domain, from the point of view of their business model practices. Benchmarking can be made using a classification system based on various key indexes. This paper presents our point of view in establishing guidance parameters for a proper benchmarking in the ship management services sector.

## 7. References

- [1] Romanescu, M. L., "The Analysis of the Benchmarking Method Specific to the Romanian Quality Assurance of Higher Education", *"Ovidius" University Annals, Economic Sciences Series, Volume XIII, Issue 2*, Ovidius University Publishing, Constanta, 2013, pp. 489-491
- [2] Păunescu M., Vlăsceanu L., Miroiu A., *Calitatea învățământului superior din România: o analiză instituțională a tendințelor actuale*, Polirom Publishing, Iași, 2011.
- [3] Raa, T., Benchmarking and industry performance, *Journal of Productivity Analysis*, December 2011, Vol. 36, Issue 3, pp 285-292.
- [4] Wenzel-Benner, C., Gräf, J., "XBX: eXternal Benchmarking eXtension for the SUPERCOP Crypto Benchmarking Framework", *Cryptographic Hardware and Embedded Systems*, CHES 2010, Vol. 6225 of the series Lecture Notes in Computer Science, Springer Berlin Heidelberg Publisher, 2010, pp. 294-305.
- [5] Weicker, R., "Benchmarking", *Performance Evaluation of Complex Systems: Techniques and Tools*, vol. 2459 of the series Lecture Notes in Computer Science, 2002, pp.179-207
- [6] Soelter et al. , "Benchmarking physicochemical vs. vibrational descriptors in predicting odor receptor responses", *Flavour* vol. 3(Suppl 1), 2014, pp:O6.
- [7] www.bimco.org
- [8] Waals, F. A. J., Veenstra, A.W., *A Forecast Model and Benchmarking of the Supply and Demand of Maritime Officers*, Erasmus University Rotterdam, 2002
- [9] Mitroussi, K. 2003, ' *Third Party Ship Management: The Case of Separation of Ownership and Management in the Shipping Context* ', *Maritime Policy and Management*, 2003, Vol. 30, No. 1, 77-90.
- [10] Christian, M., Jakobsen, E. W. and Zhovtobryukh, Y., *GCE Blue Maritime – Global Performance Benchmark*, 2015, Menon publ. no 34/2015, available at

www.menon.no

[11]<https://www.shipping-kpi.org>

[12]Bussow, T.; John, O. (coord.), *Best Practice Ship Management Study*, Germanischer Lloyd Maritime Software GmbH and Fraunhofer CML, Hamburg, Germany, 2013, pp.5-31.

**Section II**  
**Business Economy and Administration**

\*\*\*

**Subsection 3**  
**Finance and Accounting**

## Takaful Insurance and its Development Perspectives

Flavia Mirela Barna  
Miruna-Lucia Nachescu  
Victoria Seulean

*West University of Timisoara, Faculty of Economics and Business Administration, Finance  
Department*

[flavia.barna@e-uvt.ro](mailto:flavia.barna@e-uvt.ro)  
[miruna.nachescu@e-uvt.ro](mailto:miruna.nachescu@e-uvt.ro)  
[victoria.seulean@e-uvt.ro](mailto:victoria.seulean@e-uvt.ro)

### Abstract

*In the last 35 years, a new insurance system has emerged, a system that is completely different from the European or American one and is mainly based on the Muslim religion and on the Shari' a law. Being at the border between the mutual associations and the classic insurance companies, the TAKAFUL insurance was born in the Muslim countries, where the classic insurance companies were unable to offer insurance policies that would have respected the rules of the Shari' a (as demanded in the case of goods that were financed by the Islamic banks). In a very short time, this kind of insurance has extended its presence in other regions of the world and still has a high potential of growth. In the present paper we are explaining the main characteristics and principles under which it works, but we also underline the perspectives and threats of this form of protection, correlated with the risk management measures that classic insurances must prove (especially after the effects felt in the insurance business after the economic-financial crisis of 2008)*

**Key words:** Takaful insurances, operators regulatory measures

**J.E.L. classification:** G220.

### 1. Introduction

The TAKAFUL insurances have come into being in 1979, being demanded by the need of insuring the assets and businesses financed by the Arab banks, especially by those in Saudi Arabia. The term takaful is of

Muslim origin and means to insure, to support or help others. According to this concept, the community members' resources are put together, in order to help the poor members of the Islamic community, in case of urgent needs (like losses or diseases). In such cases, the principles that are applied are those of responsibility and compensation inside the community, on the basis of the Shari' a law. Starting from this, and taking into account the word of the Shari' a, that money cannot generate interest or profit and that the commercial insurance in the form and understanding given by the Europeans of Americans are assimilated to gambling (which is illegal under the Muslim law), the takaful insurance is in its core a cooperative insurance of mutual type.

### 2. Functioning principles and main characteristics of the Takaful insurance

The Takaful organizations respect many of the organizing and functioning principles specific to the mutual insurances that have a history of a few centuries. The Shari' a ("muamalat") forbids revenues out of interest, gambling and assuming risks and imposes a set of restrictions in business as well as conditions for insuring the transparency.

From the functional point of view, the Takaful insurance is a hybrid between the mutual insurance and the classic insurance. The Takaful organization functions on the mutuality principles in what concerns the payment of claims towards the insured persons that have suffered when a certain risk has occurred, but in what concerns the management of the insurance operations, it works as a normal commercial company.



This is possible, as in the spirit of the same Shari' a law (*no riba* (interest); *no gharar* (risk, incertitude); *no maysir* (gambling)) the Takaful organization's funds are divided in insured persons fund that includes the contributions of the participating members- the shareholders- and the insurance premiums paid by the insured persons, which are regarded as donations ("*tabarru* ") and the operator's fund. By treating the risk premiums as donations, the Takaful insured persons do not have their own capital in the Takaful insurance operation. On the contrary, in the case of a mutual insurer, the premiums and cotisations paid are a part of the business owed by the insured person in the contract signed with the mutual company. This has practical implications regarding the insurance activity profit distribution. While the insured persons of the mutual insurance company are getting their share of the profit, the persons insured under the Takaful insurance do not benefit of a share of the profit, at least not in the case of general insurances.

In order to manage the risks of the insurance activity, the leader of the organization (taking into account the principles of "*muamalat*"), is externalizing the business and signs and agency contract ("*wakala*" contract) with another economic agent. The contract stipulates that for the provided services, the agent is going to be paid a certain tax (commission). The contract has to be transparent and to fulfil all the requirements of conformity with the Shari' a. The management of the insurances portfolio is going to be done on the basis of this contract. In the Arabic world, there are other types of commercial contracts too, that respect the Shari' a law and are known under the name of "*mudharaba contract*" and "*murabaha contract*", but the *wakala* contracts are the best known and most used ones. From this point of view, the takaful insurances are different from the mutual insurances (where the funds paid by the members of the mutual stay in its accounts and are being managed by the mutual itself, the insured persons becoming their own insurers).

In the case of the Takaful organizations, the main sources of profit are:

1. The surplus that results out of the insurance activity, after deducting from the cashed premiums the paid claims and also the

management expenses;

2. The profit that results from the financial investments, after deducting the loses from assets, from the insurance activity and also the technical reserves that are being created in order to permit the claims payments in the future; of course the result of previous periods is also took into account;

3. The surplus that results from the subscription activity, this being the surplus of expected liabilities of the period (estimated as an average of the previous ones) over the real liabilities.

In the case of life insurances, besides the shareholders fund (that participates at an insurance pool) and the operator fund (his working capital), there is also the insured persons' fund that is constituted and managed separately. At their turn, the insured persons sign a "*wakala*" contract through which they require management and investment services to be provided, paying in exchange the "*wakala*" taxes to the operator that manages the Takaful business in their name. Those taxes are deducted from the contributions paid for insurance before they are deposited into the participants' fund.

In the Takaful organizations, the profit that results as a surplus of the insurance activity belongs to the shareholders, while the profits or losses that result from the assets managed by the agent are divided between the shareholders and the agent. The profit that results from the subscribing the premiums activity normally belongs to the agent, even if there are Takaful schemes when a part of this profit belongs to the shareholders [1].

In particular, in the case of life insurances, the profit that results out of using the insurance funds, is distributed between the insured persons on one hand (as a bonus or surplus at the insured sum that is going to be distributed according to the insurance contract) and the shareholders on the other hand. In the case of the Takaful life insurances, the profit that results from using the insurance funds is divided between the shareholders, the insured persons and the agent.

The hardest provocation of the Takaful insurance is that of managing the part of the risk premiums that is going to be used to pay the claims towards the insured persons if the insured event happens. One of the solutions

that is used in practice, when the value of the claims to be paid is bigger than that of the insurance fund and of the technical reserves, is to use the reserves funds that are in the insurance pool that was constituted on the basis of the shareholders' contributions. The insured persons can't be asked to pay supplementary premiums, these being considered donations as shown before. Still when the risk occurrence is much bigger than the initially estimated one, the Takaful organization's pooled resources are insufficient. In these cases, the operator is asked to offer a zero interest credit to the risk pool in order to cover the deficit. This credit will be paid from the value of the supplementary premiums registered in the risk pool. The way such credits (known as "qard") should be treated in the accounts of the Takaful is still a subject of debate in the insurance industry, especially for the regulating authorities. The Islamic Council of the Financial Services (IFSB) has tried to solve this important matter through the Standards regarding the solvability requirements set for the Takaful organizations (IFSB-11). (1, pp 102-105).

### 3. Regulating the Takaful organizations

As the Takaful insurances have developed at a very quick step in a short period of time, the regulating and supervision organisms were obliged to concentrate upon regulatory measures that should be applied on this market, especially as on the traditional, classic insurance market, such aspects are considered very important both by the national regulating and supervision authorities and by the international organizations in the field.

In order to offer a detail image, we have included in the next table some of the elements that are taken into account by the regulating authorities of the Takaful markets, as they are presented in the literature [1].

We took into account 6 Islamic countries, namely Malaysia, Bahrein, The United Arab Emirates, Indonesia, Sudan and Saudi Arabia as well as 8 regulating criteria, the results being presented below:

Criterion Model Takaful standardized	1. or	<b>1 Malaysia:</b> No restriction over the takaful models used but any unstandardized contract needs prior
--------------------------------------	-------	--

contract	approval. <b>2. Bahrein:</b> The <i>wakala</i> model. All takaful licensed companies must organize their activity and function according to the <i>wakala</i> . In exchange for takaful fund administration services, the shareholders of the takaful company can ask for a specific tax ( <i>wakala tax</i> ). For the insurance assets invested in the takaful funds, the operator can use the „ <i>mudharaba</i> ” model, receiving a percentage of the profit generated by the investment portfolio. <b>3. The United Arab Emirates:</b> Both the „ <i>mudharaba</i> ” and the „ <i>wakala</i> ” models are accepted by the regulations, but there are no other stipulations concerning other models that could be used. <b>4. Indonesia</b> The operating frame allows the use of „ <i>mudharaba</i> ” and „ <i>wakala</i> ”. Also, other models can be taken into account. <b>5. Sudan:</b> The frame for the model is a mixed one: „ <i>wakala</i> ” for insurance activities and „ <i>mudharaba</i> ” for investments. <b>6. Saudi Arabia:</b> No reference to the Sharia's contracts is being made; the profile industry is regulated as any cooperative but with the shareholders capital.
Criterion 2. The existence of a stipulation regarding the obligation of equal treatment between clients	<b>1. Malaysia:</b> Yes <b>2. Bahrein:</b> Yes. The code of practices in the field of insurances contains a set of principles that apply to the relation with the client. <b>3. The United Arab Emirates:</b> Yes. The top management must make sure that all the standards regarding the client

	<p>protection are adopted in each jurisdiction.</p> <p><b>4. Indonesia:</b> Yes. Insurances are regulated in such a way that there is an undiscriminating and financially valid price</p> <p><b>5. Sudan:</b> This request is implicit through the company's rules, as the company is organized as a cooperative.</p> <p><b>6. Saudi Arabia:</b> Yes. Professional conduct is regulated through specific rules.</p>
Criterion 3. The need for the actuar to certify the takaful products' prices	Yes, it exists in all countries except for Sudan and Bahrein
Criterion 4. The need to certify the Sharia's per operation	Yes, it exists in all countries except for Saudi Arabia
Criterion 5. The existence of a national Sharia's decision body	Yes, in Malaysia and Indonesia and indirectly in Sudan; No, in Bahrein, The United Arab Emirates and Saudi Arabia
Criterion 6. Limitation upon the commissions applied between intermediaries	Yes, in Malaysia and Saudi Arabia. No, in the other states
Criterion 7. Solvability requests	Yes, in all countries
Criterion 8. Regulations regarding investments	Yes, in all countries

At a closer look, we can notice that except two criteria, referring to solvability and the investments regime, there are significant differences between the national regulators.

Malaysia is known as the most developed in the Takaful regulating, having specific rules applied since 1984. The Takaful rules address aspects relating to: the capital size, financial reporting, money laundering, limits and prudential standards.

The regulating differences are even bigger in other states that use Takaful insurances, but do not have a majority Muslim population and do not fully respect the Sharia's law, such as Singapore or Great Britain.

As a first conclusion, we consider that the fact that there is no unity of regulations could lead to an increase in the innovations in the field of Takaful insurances but also to an increased risk that comes with a deregulated market.

#### 4. Quantitative development of the Takaful market

The Takaful insurance market, that appeared in the Muslim countries at the end of the 70s as an alternative to the classic insurances, with the taking into consideration of the Shari' a law, followed an ascending trend in the last 6 years (2009-2014) doubling the volume of premiums that were paid, expressed in billion dollars (Figure 1).

Figure 1. The evolution of Takaful insurances on geographic areas

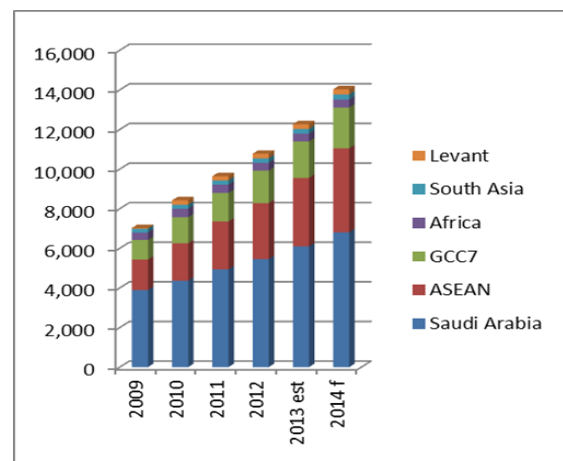

Source: Global Takaful Insights 2014 Journal, EYGM Limited Global Printing House.

In 35 years, the TAKAFUL insurances have extended a lot in the Muslim countries,

but not only (see countries such as Great Britain, Singapore, and Cambodia).

The object of such insurances is very different and usually covers general insurances more than live ones. The Takaful insurances markets is very well developed and versatile in countries from the Gulf Area – Saudi Arabia, The United Arab Emirate, Kuwait, Qatar and the Arab Emirates but also in countries from the South Asia - Malaysia, Indonesia, which offer a variety of products and services. In practice, the Takaful insurance products have found a niche connected to the insurances offered to small industrial and agricultural family businesses. These products are called Takaful family health insurances, studies insurances, life insurances, economy plans, etc.

An analysis of the distribution of brute contributions in Takaful countries in 2014, on countries and groups of countries, shows that between the countries from the Gulf zone, Saudi Arabia is leading with a total of 48% of the total value of the insurances contributions.

Figure 2. Gross contributions from the Takaful insurances on geographic areas

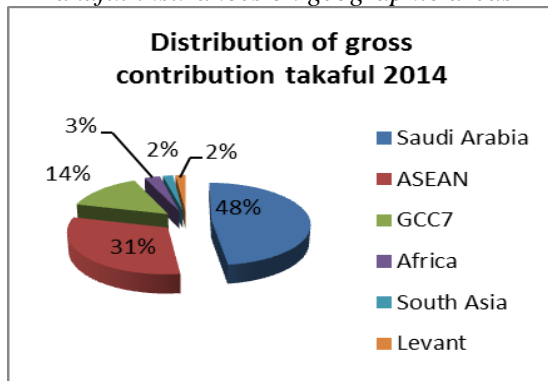

Source: Global Takaful Insights 2014 Journal, EYGM Limited Global Printing House

Malaysia is the lider in the South-East Asia, as together with Indonesia covers 31% of the market, being followed by another group of countries in the Gulf - GCC7- Bahrain, Kuwait, Qatar and the United Arab Emirates – which have a share of 14% of the total volume of Takaful contributions. The other groups of countries that are mainly Muslim in South Asia, Levant and Africa have about 7% of the market.

Even though the Takaful insurances had remarkable evolutions in the analysed

countries, one can notice a low level of penetration of the insurances, meaning that there is still a high potential for further development. An extended study, „*The way forward for Takaful. Spotlight on growth, investment and regulation in key markets*” of Hatim El-Tahir, Leader, the Deloitte ME Islamic Finance Knowledge, shows that in the countries from the Gulf Zone, the penetration rate is between 0.6% in Kuwait and 23% in Bahrein (figure 3):

Figure 3. The penetration degree of the insurances in 2012 in the Gulf Zone countries

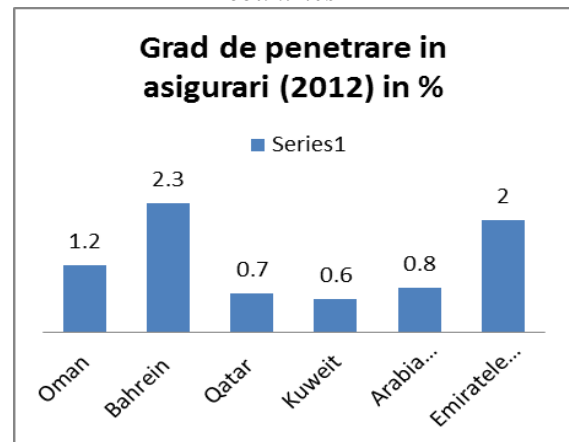

Source: Hatim EL-Tahir, „The way forward for Takaful. Spotlight on growth, investment and regulation in key markets”, 2014, pg. 10.

The level of penetration shows high potential of development of the insurance markets, especially of the Takaful insurance market as these insurances respect best the financial rules of the Islamic world.

Also, the penetration degree of the insurances is analysed along with the density of insurances that is measured through the level of insurance premiums paid by each citizen of a country. From this point of view, in the same group of countries, the situation is as presented below (figure 4):

Figure 4. Density of insurances in 2012 for the countries in the Gulf Zone (\$/Citizen)

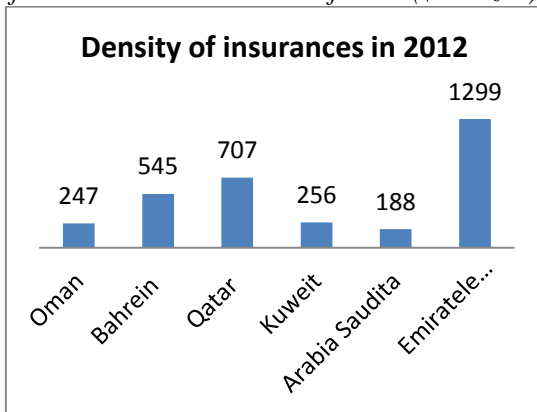

Source: Hatim EL-Tahir, „The way forward for Takaful. Spotlight on growth, investment and regulation in key markets”, 2014, page 10.

From this point of view, the biggest density is in the United Arab Emirates, with almost 1300 \$/citizen, much above the average of the region which is at 363.7 \$/citizen.

In order to compare, the same study presents different results for the South-Eastern Asia. Singapore registers a penetration degree of 5.9% and a density of 3106 \$/citizen, Malaysia, a penetration degree of 5.1% and a density of 502 \$/citizen, Thailand a penetration degree of 4.4% and a density of 222 \$/citizen. This lead us to the conclusion that in this part of the world, the financial services market and especially that of insurances is well developed and adequate to the economic realities of that area.

Seraph O. Gonulal, Hassan Scott Odierno and Zainal Abidin Mohd Kassim offer and explanation for the difference between Middle East and South-Eastern Asia starting from the models used: „Models can vary in a jurisdiction but differences are much more significant between regions. For example, the model and what is accepted in the Middle East, is very different from South-Eastern Asia, where the liberal politics are trying to encourage the development of takaful. Some of the specialists of the Middle East do not even consider that the operations from South-Eastern Asia are of takaful sort.”[1]

## 5. Conclusions

Economic growth generated by the takaful

insurance sector and the success registered by the operators of this market varies from one market to another, according to the market maturity and the level of economic development.

Another factor that also influences the profitability of the Takaful insurances is the regulation degree.

Despite the volatility of the financial markets, the Takaful market has registered consistent growth, having three key markets in Saudi Arabia, The United Arab Emirates and Malaysia.

There are also countries as Turkey, Pakistan, Indonesia and other Islamic countries that have created new rules in the field in order to open a new way of access for the Takaful insurance market.

There are still lots of opportunities for the development of this market, especially in the emerging markets.

We consider that in the case of the Romanian market, even if considered very useful, such insurance products are not going to find a market because, at least up to now, they are not complying with the requirements of the Solvency II Directives that are coming into force starting on the 1<sup>st</sup> of January 2016.

## References

- [1]. Gönülal, S. - Takaful and Mutual Insurance „Alternative Approaches to Managing Risks”, 2013. Takaful and Mutual Insurance: Alternative Approaches to Managing Risks. Washington, DC: World Bank.
- [2]. El-Tahir, H. - FCIB, FCISI, Deloitte ME Islamic Finance Knowledge ”The way forward for Takaful Spotlight on growth, investment and regulation in key markets”, 2014.
- [3]. Nazim, A. Rashid, D., Bruce, B., Cheong, P., Muhyidin, A., Ali A., Shakeel, A., Hatipoglu, M., *Global Takaful Insights 2014*, Journal, EYGM Limited Global Printing House.

## Ab initio: A historical Perspective on Accounting

Larissa Bătrâncea

*Babeş-Bolyai University, Faculty of Business*

[lm.batrancea@tbs.ubbcluj.ro](mailto:lm.batrancea@tbs.ubbcluj.ro)

### Abstract

*Ancient Mesopotamia is the source for one of the most crucial inventions that shaped the face of the accounting field, i.e., writing. In the absence of writing, the fundamental principle of accounting, that is ensuring the accordance between records and facts, could not have been applied. The present article is centered on a brief historical inquiry that highlights major landmarks in the development of accounting.*

**Keywords:** accounting, double entry bookkeeping, historical perspective.

**JEL Classification:** M41, N40.

### 1. Under the aegis of the beginning

"We are not makers of history. We are made by history" stated once the renowned American activist and humanitarian Martin Luther King. His tenable statement may be applied to any research field, including accounting where the present-day advancements and regulations were shaped and steered by earlier progress. The article will be centered on a brief historical inquiry that will highlight major landmarks of the earlier progress.

In 1492, Christopher Columbus discovered The New World of the (future) South-American continent. From 1519 until 1522, Magellan circumnavigated the earth, being the first man to achieve that. Between these dates, in the year 1494, in an era of Renaissance and great exploratory journeys, Luca Paciolo "discovered" to the new world of printing an accounting method that would later surround the globe: *double-entry bookkeeping*. Though Paciolo is not the inventor of accounting, he has the merit of synthesizing and later registering via printing the accounting practices of his time in a treatise called "Summa di Arithmetica,

Geometria, Proportioni et Proportionalita".

It could be argued that accounting history was written until and from Luca Paciolo onwards. Therefore, a journey through the avatars of such captivating domain could be described along four major stages: 1) the accounting written on cave walls, animal bones or knotted strings (period which I dubbed „proto-accounting"); 2) the accounting written on clay tablets, papyrus or parchment; 3) the accounting subscribed to the scientific apparatus called double-entry bookkeeping; 4) the accounting prescribed by the legislative framework from various parts around the world; 5) the accounting circumscribed to international harmonization requirements.

### 2. Mesopotamia and the invention of writing

Mesopotamia, the first antique civilization, considered the cradle and the prototype for the limitrophe civilizations, gave humanity a vast cultural and spiritual treasure. It was also the source for a complex of material and practical discoveries such as the wheel, plow, first medicine, textiles, mathematics and astronomy, grammar, the renowned Hammurabi law codex.

Nevertheless, the Mesopotamian discovery born out of practical necessities, endowed with spiritual utility and which later constituted the most important premise for the appearance of accounting was *writing* [1-4]. In the absence of writing, the fundamental principle of accounting (i.e., ensuring the accordance between records and facts) could not have been applied. In this line of thought, one has to understand the series of practical transformations (economic, social) that determined the emergence of accounting.

In the life of the early Mesopotamian inhabitants (i.e., the Sumerians), who were farmers around 6500 B.C., the first of those transformations was the implementation of

the irrigation system. That triggered an increase in the crops and food resources, in the demographics and resulted ultimately in the establishment of the first human settlements. More food also favored the emergence of crafts, exchange and merchants, administrators, in other words it favored social stratification.

At the macro level, such a civilized and complex society needed to rigorously administer and centralize activities, control and implement a legislative system. At the micro level, it required a viable management of the ongoing transactions. All these necessities led to the invention of writing, which was first used to prepare receipts, to keep evidence of inventory, delivered quantities, crops, obligations towards temples, etc.

In this vein, the first written records were found in the oldest known urban settlement (i.e., Uruk) around 3300 B.C., under the form of pictograms. Most researchers agree that the arrival of accounting in people's lives happened with the creation of writing. There are also researchers who deem that accounting emerged thousands of years before writing, namely 40000 ago, along with the cave paintings from Lascaux (France) and Altamira (Spain). Besides animal drawings, the paintings contain also representations with an abstract character, some of which are assumed to be accounting evidence and inventories, property records, etc.

Without favoring either of the two opinions, I will denominate all economic evidence and calculus born along with writing as *accounting* and all records concerning the economic activities conducted before the invention of writing as *proto-accounting*.

After the cave paintings, the following records with accounting character date back to the period 30000-25000 B.C. They were also discovered in France under the form of notches on animal bones, ivory and rocks and were probably used by people to keep track of tools, hunting prays and food. Similar evidence was discovered around 15000 B.C. on today's territories of Israel and Jordan and around 6500 B.C. in nowadays Democratic Republic of Congo.

It was discovered that Mesopotamian farmers had used ab initio clay seals in order to register the number of animals, cereals and

tools owned as mnemonic techniques. In other parts of the world, the series of mnemonic accounting methods comprised strings of polychrome beads used by Native Americans and the Inca polychrome bunches of ropes [5]. Other primitive people used scores, rods or similar systems of evidence that encompassed sometimes coded meanings for the purpose of preserving advantages during fights for conquest or defense.

The pictographic accounting records from Uruk, Ur, Nippur and Lagash announced the coming of the first writing that will dwell on the Mesopotamian lands for thousands of years, i.e., the cuneiform writing [6-8]. This will be performed by printing quantitative evidence on a soft clay tablet with the help of a piece of cane. These tablets were then dried and burned, resulting in the first justifying documents from the history of accounting.

The question to be asked is how people made the shift from the cuneiform accounting records performed on mnemonic support to the ones on clay tablets. According to some historians, the mystery was unraveled at the archeological site of Ain Ghazal from Jordan, where clay pieces with different shapes (cons, spheres, figurines, tools) were found [9]. It is belied that the tools were used to register: the number of animals, quantities of grains, oils and different food; even more abstract records like the number of hours worked by a person during a day or a week. At the same site, a clay container was found carrying several clay pieces, identical or similar to the ones found initially. On the container, archeologists observed several notches most probably related to trade activities or taxes due to temples. It is assumed that people thought of replacing the cumbersome effort of inserting and removing objects from containers with the easier process of recording transactions directly on containers. With time, containers were flattened and transformed into clay tablets, i.e., the first material support of writing. Extremely complicated at the beginning, these accounting records were simplified with time by the "accountants" of the ancient times who began to use the stylus.

The aforementioned discovery comes years after the one from Nippur where archeologists found tablets dating back to the third millennium B.C. or the ones from Nineveh. It is not known with certainty

whether all the tablets discovered belong to the accounting field, but one thing is certain: at least some of them represent the first written accounting documents uncovered until now.

### **3. A glimpse in the ancient society and accounting practices**

In Mesopotamia, writing was the prerogative of scribes, who were coming from wealthy families and were trained in special schools. Classes for teaching the writing system were organized at waterfront. In the first class, children were taught the technique of preparing the clay material and in the following classes they learned to use pieces of cane. Clay tables had the shape and the size of a palm, were disposable and inscribed on both sides: the teacher wrote on the front and the student copied on the back what the teacher had written. At the end of the class, the tablets were thrown, this being the reason for which so many were found after archeological research.

The real cuneiform writing crystallized around 2400 B.C. and was used in the Middle East under various forms until the first century A.D. Up to this period, children had been learning for centuries to draw pictograms and images, each image representing a word or a given object. This writing system, extremely limited and very complicated, had perfected with time, because the sign had come to represent a sound, not an object. Hence, the transition from the writing based on word to the writing based on sound had been accomplished, but with some costs. For instance, abstraction led to a drop in the Sumerian signs from 2000 to 500. In the same time, signs underwent a simplification process, meaning that the symbol did not resemble the original image at all.

When reaching maturity, children accustomed to the writing system became "civil servants, extremely useful to the state administration and temples" [10]. At that time, temples were spiritual and commercial centers of the Mesopotamian city-states, they were economically and not politically dominated. Inside temples, in the rigorous accounting books, scribes kept evidence of taxes levied as money, animals, cereals, clothing, and handmade items from the

general population. Very important, receipts were released after tax levying. Temples generally owned farming lands, constructions, craft workshops, herds which were then lent to the population. Rent and profit resulting from the use of such properties were given to the temples, which kept a thorough evidence of the persons involved in these arrangements.

A third practice of temples was the banking operation: granting loans with interest, "operations of exchange, selling and buying of buildings, cashing commissions" [10]. For this purpose, temples stored commercial documents of merchants and individuals like contracts, transactions, receipts, offers, etc. [10]. The majority of this economic evidence was kept on clay tablets under the form of accounts that contained the following elements: "categories of objects sold, name of participating parties, quantities and total sales. The accounts on the tablets indicated all the elements that can be found in the regular accounts like: the balance of the previous period, the series of positive accounts, followed by the series of negative accounts and the final balance. Records were made vertical" [11].

Besides economic activities, temples dealt not only with instructing scribes but also with expanding the scribes' knowledge on various domains. Temples also supported activities in the field of science, artists' workshops, writing, stored religious, historical, literary or juridical writings [11].

Hence, the majority of accounting activities were unfolding inside temples. The rest of the accounting records were related to individual commercial activities aimed at enlisting all elements resulting from exchanges between trade parties.

### **4. Legislative framework**

The first complex juridical, economic, social and military law of Antiquity was Hammurabi's Code. This law had a major impact on people in the Middle East, just like the Roman law had on modern European civilization [11]. Historical sources suggest there were two versions of this code. Yet only one was discovered at Susa (today's Iran), engraved on a black basalt stele. It contained 282 law articles, a prologue and a lost epilogue. The ruler enacting the legal



corpus, King Hammurabi, lived (according to some historians) in the period 1792- 1750 B.C. or in the period 1728-1686 B.C. (according to others). He established an official governing system that was embraced by all the subjects. With respect to the economic-accounting domain, Hammurabi's code reveals that Babylonians "used justifying documents and were knowledgeable about the notions of active and passive. Moreover, they possessed knowledge in the technique of computing interest for the amounts levied by the state and written in the accounts, but also in registering interests [11]. According to researchers, the novelty of Hammurabi's code stands in the fact that it strictly defined the right and obligations of each caste of society. Merchants especially were not neglected: they benefited from the opening of the markets, unifying of currency, weights and measurement systems [12].

Hence, for the first time, the intention of committing wrongdoings is taken into consideration. That is to say, King Hammurabi abolished judicially the well-known "eye for an eye" retaliation law.

## 5. Conclusions

Like any living thing, the once famous Mesopotamian civilization has been covered by the age desert. Today, on its ruins stands Iraq. Nevertheless, Mesopotamia lives through its civilization and especially its historical legacy. As a case in point, the occupation of scribe still exists today in Iraq. Moreover, the people living in the southern moorlands of the country have a *modus vivendi* similar to that of the Sumerians.

Among all the important ancients have left, writing particularly brought high economic benefits to both ancient and modern societies, because it facilitated the emergence of a system providing quantitative data on finances, i.e., *accounting*.

## 6. References

- [1] Fischer, S.R., *A History of Writing*, Reaktion Books, London, 2001.
- [2] Robinson, A., *The History of Writing: Alphabets, Hieroglyphs & Pictograms*, Thames & Hudson, New York, 1995.
- [3] Nakanishi, A., *Writing Systems of the World: Alphabets, Syllabaries, Pictograms*,

- Charles E. Tuttle Company, Vermont, 1980.
- [4] Sampson, G., *Writing Systems: A Linguistic Introduction*, Stanford University Press, Stanford, 1985.
- [5] Mureșan, C., *Istoria Scrierii*, Editura Științifică, București, 1995.
- [6] Hooker, J.T., *Reading the Past: Ancient Writing from Cuneiform to the Alphabet*, Barnes & Noble, 1998.
- [7] Finkel, I., Taylor, J., *Cuneiform: Ancient Scripts*, J. Paul Getty Museum, 2015.
- [8] Walker, C.B.F., *Cuneiform (Reading the Past)*, University of California Press, 1987.
- [9] Schmandt-Besserat, D., *How Writing Came About*, University Texas Press, 2006.
- [10] Drimba, O., *Istoria Culturii și Civilizației*, Vol. I, Editura Științifică și Enciclopedică, București, 1984.
- [11] Demetrescu, G.G., *Istoria Contabilității*, Editura Științifică, București, 1972.
- [12] Paraire, P., *Mari Lideri ai Istoriei Mondiale*, Editura Arc, București, 1999.

## Interviewing - An Investigative Technique Used by Forensic Accountants

Nicolae, Bobițan,  
Diana Dumitrescu

West University of Timisoara

[nicolae.bobitan@e-uvt.ro](mailto:nicolae.bobitan@e-uvt.ro), [diana.dumitrescu@e-uvt.ro](mailto:diana.dumitrescu@e-uvt.ro)

### Abstract

*Professional accountants involved in forensic accounting activities use interviewing like a very common and useful source of knowledge. Accountants need to have the ability to interview different subjects like key personnel's, clients, or anyone who is direct and indirect involved in the case, in order to acquire knowledge and obtain information that could identify key issues of the investigated aspects. Through successive questions addressed to the persons who have knowledge of events, people, evidence and other details surrounding a case, the accountants obtain sources of evidence, and clarify some aspects with the purpose to put all the pieces together.*

*This study will be a qualitative research based on the literature survey that has the purpose to explain the importance of interviews like necessary tools for forensic accountant's activity.*

*The research results in conclusions that contribute to help the professional accountants in engagements that will determine the facts surrounding complex financial matters.*

**Key words:** Interview, investigation, evidence, forensic accountant

**J.E.L. classification:** M42

### 1. Introduction

Interviewing is an important investigative technique used by professional accountants, with the purpose to gather information or evidence regarding some issues.

The AICPA (American Institute of Certified Public Accountants) describes an interview as a professional conversation that is conducted with a specific goal and purpose

in mind and that the primary purpose of most interviews is to gather evidence through facts and information that the interviewee provides during the interview.

Sometimes, professional accountants like external and internal auditor or forensic accountant or fraud examiners need to understand a situation and to find out details regarding a case. This understanding could be obtained through a set of systematic questions addressed to a knowledgeable person.

For any professional accountant it is important to study and to pose the art of effective interviewing even in information or admission seeking, and to develop the necessary skills for it.

The main characteristics for an effective interview are to have a strategic planning, relevant questions and an objective attitude.

For a successful interviewing, the interviewer should be an active listener and a good observer. Therefore, it is more important to listen than talk, and not only to hear what had the interviewee said, but also how it is been said. In addition, for a good result, the interviewer must be objective and to manifest a professional attitude.

Forensic accountants frequently use interviewing in order to gather information regarding investigations that involves different business` events, or sometimes, even frauds. In this situation, they have to pay attention how the interview`s process is organized and to develop good practices in respect of that.

The typical audit interview is a question and answer formatted discussion normally conducted at the interviewee's workstation; the interviewee is generally a willing participant assisting the interviewer in the process of determining the facts. Once all interviews have been completed, the audit manager should read all of the interview

documentation memos, looking for themes and patterns.

An interview is a conversation with a purpose. The purpose is to obtain information and, in some cases, an admission.

But the same as a person became a good driver only after many kilometres, an experienced interviewer involves many interviews and to learn from any success or failures. As many studies show the best way to develop necessary skills is to sit in or observe experienced interviewers at work.

The most known categories of interviews are information seeking interview and admission seeking interview.

The information seeking interview provides information about the company, the industry, or the accounting at issue and is a necessary part of an investigation, providing knowledge that will sustain further inquiry. The admission seeking interview is the most challenging because requires substantial skills that are necessary for obtaining the confession of a financial crime or admission to knowledge about a crime from perpetrators, or those who possess special knowledge of crimes which have occurred (Golden and Dyer, 2006).

## 2. Research methodology

This paper has the objective to describe the most important characteristic of the interviewing as investigative technique used by professional accountants, and has the purpose to offer a descriptive model for accountants in the process of organizing a successful interviewing necessary for obtaining knowledge and information regarding some financial aspects that are investigated by them. This research attempts to identify key stages of an interviewing organizing as a way to obtain information by accountants in an investigative process.

The article is a qualitative research, based on a reviewing of the relevant publications, papers and books, also personal professional experience of the authors represents an excellent contribution at the paper's writing and at the improvement of the practices used by professional accountants. The findings of this paper are expected to assist professional accountants in developing a successful interviewing by proposing the good practices that are involved.

The research methodology use deductive methods regarding theoretical concepts involved and inductive methods like observation and induction based on the practical experience and as the result of many unstructured interviews that authors have had with the professional accountants.

## 3. Literature Review

Conducting in the best manner an effective interviewing could be considered a real art. The actual stage of development in this area is the result of many psychological and sociological research, in addition with what had been learned from the police officers interrogation's techniques.

Also, there are entire courses, programs or textbooks organized or published by professional accountant's organizations with the purpose to help the accountants to develop necessary skills for conducting an effective interviewing, and to train professionals in conducting interviews.

The AICPA ([www.cpa2biz.com](http://www.cpa2biz.com)) offers interviewing courses such as "Finding the Truth: Effective Techniques for Interview and Communication."

Additional interview training resources include the Association of Certified Fraud Examiners ([www.cfenet.com](http://www.cfenet.com)) and the Institute of Internal Auditors ([www.theiia.org](http://www.theiia.org)).

Forensic accountants have extensive experience in investigations to determine solutions to disputed accounting matters; they are often tasked with writing expert reports on their investigation. [3]

In order to investigate a case the forensic accountant should examine, study, search, track and gather information that answers questions or solves problems.

The techniques that are used in forensic accounting differ from techniques that are used in normal accounting methods. Although these methods differ, the use of other techniques and skills may be used along with investigation techniques, a legal understanding and a natural tenacious desire to uncover a hidden issue. [8]

Interviewing is a critical part of a forensic investigation, it can assist the forensic accountant with a final purpose to obtain answers for some basic questions: who, what, where, when, how and why (AICPA -

Conducting Effective Interviews).

Experienced forensic accounting investigators know that the great majority of white-collar crimes are solved by a skilled interviewer, not by other forensic means. Arguably, there is no more compelling proof of a crime than a perpetrator's voluntary admission. [1]

Forensic accounting evaluations often use interview techniques designed to obtain an admission of guilt by the person(s) involved with the fraud scheme. [1]

The investigations also involve detailed document reviews. [1]

Data mining of entries in data bases is another important forensic accounting technique. [1]

#### 4. Developing an effective interview

There are some important rules that any professional accountant need to respect for organizing an effective interview.

The location where the interviewing is located has to ensure privacy, an easy access and to offer a comfortable and safety ambient for both, interviewer and interviewee. A good location could be the offices, where the interviewer or the interviewees' job, during the normal programmes hours.

The interviewer's language it is important to be respectful, to avoid confusing the interviewee and to have a peaceful tone.

The interviewer has to be straightforward, quiet and to manifest patience, to know in every moment where to conduct the discussion, and to move circle back if it is necessary.

The best practices recommend that an interview to be conduct by two persons: one lead interviewer who put the questions and observe the interviewee's verbal and non-verbal behaviour and a second interviewer who takes notes. [5]

In order to obtain the best picture of an event or case an interviewer has to take into consideration:

- To listen more than to talk and to watch as well as to listen;
- To allow the interviewee to tell the story by using more the open-ended questions;
- Do not use a prepared list of questions and to have a spontaneous and flexible conversion;
- Do not ask leading questions that

explains what the interviewer is looking for;

- Do not use double-negative questions because they are confusing and often suggest an answer opposite to the correct answer or complex questions that require more than one answer and cover more than one topic because these can lead to confusion. [9]

A professional accountant starts an effective interview by planning and developing an overall strategy. For the beginning, the interviewer should identify all appropriate data, documents, persons and information and to make the connection between them regarding the investigated subject matter.

After that, the accountant knows who are the persons that will be interviewed (such as bookkeepers, accounting clerks, operational` personnel, management` personnel, etc., from the lower levels of employees to the highest level) and what aspects the interview have to cover. [6]

An effective interviewing has **three stages** for development:

1. *Introduction stage* – the parts meet each other and the interviewer establishes a first relation with the interviewee and states the reason for the interview.

2. *Body stage* – the interviewer review the facts and the evidence of the case with the interviewee, and based on some open-ended questions, with patience, gather information, listen and understand the answers. A good option for interviewer is to have a checklist and pre-written questionnaires.

3. *Close stage* – The interviewer review and summarize important aspects of the interview, clarify some responses and end with a positive, leave the door open note.

The most important **types of Interview Questions** are:

1. *Introductory Questions* – contains background questions regarding the name, address, phone number, title, how long the interviewee have been in that position as well as what their duties are;

2. *Informational Questions* – are designed to gain an understanding of the events documents and circumstances relating to the preparation of documents or to understand operations and procedures of an organization from the perspective of the interviewee;

3. *Open Questions* – are used by the interviewers to get a quick summary of what is known about a matter, or to understand an

event or incident, and the interviewee is narrating a series of events or is giving some explanation;

4. *Closed Questions* – requires a precise answer, usually “yes” or “no”, and can be used to establish amounts, dates, times and locations, often during the conclusion phase of the interview.

Conducting an effective interview represent for a forensic accountant a three phases process. Phase one of this algorithm is when the interviewee does most of the talking. The forensic accountant should make use of open-ended questions and he should make sure not to interrupt the interviewee. This can be done by timing his comments and necessary questions carefully.

Phase two of the method is that the forensic accountant can ask the interviewee basic questions based on the interviewee’s free-report recollection of the event.

Phase three consists of directing the interviewee to make a second attempt are trying information that answers questions that phase one and two did not cover. [7]

An important factor that the forensic accountant should consider is to ask the interviewee for any supporting documentation relating to his information. [1]

Upon conclusion of the interview, the forensic accountant should institute a trust relationship with the interviewee, as this will assist in assuring future cooperation. [4]

## 5. Conclusion

Interviewing is performed with the purpose to obtain background information about the subject matter of the investigation. An interview is essential in order to gather facts and to conduct investigation in the right direction. Interviews generally should respond to some basic questions: who, what, where, when, how and why. An interview requires strategic planning, relevant questions and an objective interviewer in order to be successful.

When a forensic accountant perform an interview will try to find out what the interviewee know about the case, how the individual got the information, who are the persons involved, when and where the event occurred, what are the details of the story e.g., who, what, when, where, why, and how much, what are the dates or the period of the

key events, what evidence exists to confirm and where could be find, what other persons have pertinent information, what motivations have the persons involved in the investigated facts, and if the interviewee could be credible.

The main research objective of the article was to determine how a forensic accountant will conduct an interview as a most important investigation technique. This objective has been fulfilled by clear explanation of this kind of forensic accountants investigation. Based on the information obtained as a result of the interviews and other investigation techniques, the forensic accountants compile a report about their findings. This report is then used as evidence when the forensic accountant provides their opinions to the court.

## 6. References

- [1] Golden, T.W., Dyer, M.T., *The Art of the Interview. In A Guide to Forensic Accounting Investigation*, edited by Golden, Thomas W., Skalak, Steven L., and Mona M. Clayton, 349-364, Hoboken, NJ: John Wiley & Sons. Inc., 2006
- [2] Clayton, M.M., *A Guide to Forensic Accounting Investigation*, edited by Golden, Thomas W., Skalak, Steven L., and Mona M. Clayton, Hoboken, NJ: John Wiley & Sons. Inc., 2006
- [3] Telpner, Z., Mostek, M., *Expert Witnessing in Forensic Accounting*, CRC Press, 2003
- [4] ACFE (Association of Certified Fraud Examiners) - “The Confession Interview: Ethical, Legal, and Psychological Implications for the Forensic Accountant”, online at [http://www.acfe.com/uploadedFiles/ACFE\\_Website/Content/canadian/2013/presentations/5B-Scott-Porter-cpp.pdf](http://www.acfe.com/uploadedFiles/ACFE_Website/Content/canadian/2013/presentations/5B-Scott-Porter-cpp.pdf), 2013
- [5] ACFE (Association of Certified Fraud Examiners) - 2015 Fraud Examiners Manual, International Edition, online at [http://www.acfe.com/uploadedFiles/Shared\\_Content/Products/Books\\_and\\_Manuals/2015%20International%20Sample%20Chapter.pdf](http://www.acfe.com/uploadedFiles/Shared_Content/Products/Books_and_Manuals/2015%20International%20Sample%20Chapter.pdf)
- [6] AICPA - Conducting Effective Interviews, online at [http://www.aicpa.org/InterestAreas/ForensicAndValuation/Resources/PractAidsGuidance/DownloadableDocuments/10834-378\\_interview%20whiite%20paper-FINAL-v1.pdf](http://www.aicpa.org/InterestAreas/ForensicAndValuation/Resources/PractAidsGuidance/DownloadableDocuments/10834-378_interview%20whiite%20paper-FINAL-v1.pdf)
- [7] Leinicke and al., 2005 - Interviewing as an Auditing Tool, *The CPA Journal*,

- <http://search.proquest.com/docview/212269969?pq-origsite=gscholar>
- [8] Slot, J., "An evaluation of the forensic accountant's role in criminal law proceedings", online at [http://dspace.nwu.ac.za/bitstream/handle/10394/9839/Slot\\_J.pdf?sequence=1](http://dspace.nwu.ac.za/bitstream/handle/10394/9839/Slot_J.pdf?sequence=1)
- [9] Vinluan, F, Tips for conducting a forensic interview, *Journal of Accountancy*, 2015

## Possibilities of Using the Typical Survey in Audit

Sorin Briciu

University "1<sup>st</sup> of December 1918", Alba Iulia  
[briciusorin@gmail.com](mailto:briciusorin@gmail.com)

Dimi Ofileanu

University "1<sup>st</sup> of December 1918", Alba Iulia  
[dimi\\_ofileanu@yahoo.com](mailto:dimi_ofileanu@yahoo.com)

### Abstract

*Due to its undisputed advantages, which make it much more efficient and economic compared to total research, the statistical survey can successfully used in audit. The efficiency of the statistical survey depends, among others, on the size of the sample and the type of survey used. If the survey is properly used then the conclusions are more accurate than in the case of using other methods. The article presents possibilities of applying the typical simple, proportionally and optimally survey (repeated or unrepeated) in the audit of accounting documents and records.*

**Key words:** audit, sample, random survey

**J.E.L. Classification:** M42

### 1. Introduction

The use of the survey in audit allows the research of accounting documents and records in order to draw some general conclusion by reducing the number of studied elements and by the possibility to research each of them in detail [4], [5].

The International Standards on Auditing (ISA 530) allow the use of survey in audit [2], the choice of the type of the survey used being left to the discretion of the auditor.

The aim of the auditor is to obtain results which are close to the ones obtained in the case of a total research. The choice of the wrong type of survey will automatically lead to large differences between the results obtained by the survey and the ones which characterize the total population [1].

Next we will tackle the typical survey and its applicability in audit.

### 2. The typical simple repeated survey

Are subject to audit all accounting records and the primary documents which serve as their basis, from a financial year of a company within which is organized an accounting department. They will be statistically observed in connection with the variables  $x_{doc}$ ,  $x_{ic}$ ,  $y_{doc}$ ,  $y_{ic}$ , defined below.

The primary documents will be statistically analyzed under the following aspects:

- if the documents present deviations from the point of view of the form and content:

$$x_{doc} = \begin{cases} 1, & \text{if the document is correctly drawn} \\ 0, & \text{if the document is incorrectly drawn} \end{cases}$$

- if the documents present deviations regarding the amounts shown:

$$y_{doc} = [\text{correct value} - \text{val. from document}]$$

The accounting records will be analyzed under two aspects:

- qualitatively: if the accounting record is correctly made from all points of view (the correspondence between accounts is real):

$$x_{ic} = \begin{cases} 1, & \text{the accounting record is correct} \\ 0, & \text{the accounting record is incorrect} \end{cases}$$

- quantitatively: regarding the amount corresponding to the accounting record :

$$y_{ic} = [\text{correct value} - \text{value from the accounting record}].$$

The number of documents from the financial year is of 30.000, and the one of accounting records is 14.000. The researcher fixes the precision settings to  $\alpha = 95\%$  and  $R = 1\%$ . Also, he establishes a sample representing 10% from total population with a probability of the results of 95%.

For the audit of accounting records it was verified the size of error in existing records sorting them on sections depending where they were made. It has to be mentioned that

the sorting has been made only on the 5 sections of the company, not including the central accounting office where the 5 sections are centralized (it has been considered that the data from the 5 sections has been correctly transmitted to the central office) There are 5 layers for the 5 sections: section 1 – layer 1, Section 2 – layer 2, Section 3 – layer 3, Section 4 – layer 4, Section 5 – layer 5. Because of the fact that it will be applied the typical survey, the size of the sample will be the same for every layer. Because  $n = 10\% \cdot N_{i.c.}$  and  $N_{i.c.} = 14.000$ , we have  $n = 1.400$  By dividing the sample to the number of layers (5) we obtain the size of the sample for each layer:  $n_i = 1.400/5 = 280$ .

We observe each layer (section) and we obtain:

- S1: there were found 5 errors of: 100, 125, 160, 80, and 95 lei;
- S2: there were found 2 errors of: 960 and 1.000 lei;
- S3: there were found 3 errors of: 3.500, 4.100, and 3.600 lei;
- S4: there was found an error of 560 lei;
- S5: there were found 2 errors of: 2.700 and 2.900 lei.

We process the data collected from each layer (in hundreds lei):

$$\begin{array}{ll} \bar{y}_1 = 0,02 & \bar{s}_1^2 = 0,0234 \\ \bar{y}_2 = 0,07 & \bar{s}_2^2 = 0,68138 \\ \bar{y}_3 = 0,4 & \bar{s}_3^2 = 14,84714 \\ \bar{y}_4 = 0,02 & \bar{s}_4^2 = 0,1116 \\ \bar{y}_5 = 0,2 & \bar{s}_5^2 = 5,56714 \end{array}$$

In the case of typical simple survey, if the number of layers is noted with k we have:

– estimation of the average:  $\bar{y} = \frac{\sum_{i=1}^k \bar{y}_i}{k}$

– dispersion average:  $\bar{s}^2 = \frac{\sum_{i=1}^k \bar{s}_i^2}{k}$

It will be obtained:

$$\bar{y} = \frac{\bar{y}_1 + \bar{y}_2 + \bar{y}_3 + \bar{y}_4 + \bar{y}_5}{5} = 0,142$$

$$\bar{s}^2 = \frac{\bar{s}_1^2 + \bar{s}_2^2 + \bar{s}_3^2 + \bar{s}_4^2 + \bar{s}_5^2}{5} = 4,246132$$

We calculate the dispersion coefficients on every layer and we obtain:

$$CV_1 = \frac{\bar{s}_1}{\bar{y}_1} \times 100 = 764\% , CV_2 = 1179\% ,$$

$$CV_3 = 963\% , CV_4 = 1670\% , CV_5 = 1180\%$$

The dispersion is very large on each layer, so, on every layer the population is not homogeneous, Because of that, we won't apply the stratified survey, or it will be differently grouped so that the population is homogeneous on all layers.

The audit was made on the number of incorrect accounting records too, and for each layer we obtained:

Layer	S1	S2	S3	S4	S5
Incorrect records	6	4	3	3	2

We process the data collected on each layer as it follows:

$$\begin{array}{ll} W_1 = 0,97857 & \bar{\sigma}_{w_1}^2 = 0,02097 \\ W_2 = 0,98571 & \bar{\sigma}_{w_2}^2 = 0,01408 \\ W_3 = 0,98928 & \bar{\sigma}_{w_3}^2 = 0,0106 \\ W_4 = 0,98928 & \bar{\sigma}_{w_4}^2 = 0,0106 \\ W_5 = 0,96527 & \bar{\sigma}_{w_5}^2 = 0,03352 \end{array}$$

We obtain:

$$W = \frac{W_1 + W_2 + W_3 + W_4 + W_5}{5} = 0,981622$$

$$\bar{\sigma}_w^2 = \frac{\bar{\sigma}_{w_1}^2 + \bar{\sigma}_{w_2}^2 + \bar{\sigma}_{w_3}^2 + \bar{\sigma}_{w_4}^2 + \bar{\sigma}_{w_5}^2}{5} = 0,017954$$

We calculate the dispersion coefficients on layers and we obtain:

$$CV_1 = \frac{\bar{\sigma}_{w_1}}{W_1} \times 100 = 14,80\% , CV_2 = 12,04\% ,$$

$$CV_3 = 10,41\% , CV_4 = 10,41\% ,$$

$$CV_5 = 18,97\%$$

Because all dispersion coefficients are acceptable limits (<35%) it results that the population is homogeneous on each layer, so the stratified survey can be applied:

–average survey error:

$$\hat{\sigma}_w = \frac{\bar{\sigma}_w}{\sqrt{n}} = 0,0035811$$

–limit survey error  $\Delta_w = Z_\alpha \cdot \hat{\sigma}_w = 0,007019$

– confidence interval:

$$P(0,981622 - 0,007019 < p < 0,981622 + 0,007019) = 95\%$$

$$P(0,9746 < p < 0,9886) = 95\%$$

so the share of accounting records correctly drawn is in the interval (97,46%-98,86%), and the one of those which are incorrectly



drawn is in the interval (1,14%-2,54%). Multiplying by 14.000 we obtain the number of accounting records correctly drawn in the interval (13.644, 13.840) and the interval for the number of accounting records incorrectly drawn (160,356).

### 3. The typical simple unrepeated survey

Taking the same example, we apply the same type of survey on the audit of accounting documents. The size of the total sample will be  $n = 10\% \cdot N_{doc}$  and because  $N_{doc} = 30.000 \Rightarrow n = 3.000$ . This way we obtain the size of the sample for every layer  $3.000/5 = 600$  (documents).

We make the observation in relation with the size of error from documents and we obtain the following errors corresponding to each layer:

- S1: 85; 120; 80; 115; 110; 90 lei;
- S2: 900; 1.100; 1.000 lei;
- S3: 3.600; 3.850; 4.200; 3.950 lei;
- S4: 580; 620 lei;
- S5: 2.800; 2.950; 3.250 lei.

We process the data collected on each layer (in hundreds lei):

$$\begin{aligned} \bar{y}_1 &= 0,01 & s_1^2 &= 0,01014166\epsilon \\ \bar{y}_2 &= 0,05 & s_2^2 &= 0,5008333 \\ \bar{y}_3 &= 0,26 & s_3^2 &= 10,1032333 \\ \bar{y}_4 &= 0,02 & s_4^2 &= 0,1197333 \\ \bar{y}_5 &= 0,15 & s_5^2 &= 4,4415 \\ \bar{y} &= 0,098 & s^2 &= 3,035 \end{aligned}$$

We calculate the dispersion coefficients on each layer and we obtain:

$$\begin{aligned} CV_1 &= 1007\% , CV_2 = 1415\% , \\ CV_3 &= 1223\% , CV_4 = 1730\% , \\ CV_5 &= 1405\% \end{aligned}$$

so the dispersion is very large on each layer; it results that on each layer the population is not homogeneous so we won't apply the stratified survey or it will be grouped in a way that the population is homogeneous on each layer..

We make the audit on the number of documents too and we obtain:

Layer	S1	S2	S3	S4	S5
Incorrect documents	8	6	5	2	6

We process the data collected on each

layer as it follows:

$$\begin{aligned} W_1 &= 0,986666 & \sigma_{w_1}^{-2} &= 0,0131562 \\ W_2 &= 0,99 & \sigma_{w_2}^{-2} &= 0,0099 \\ W_3 &= 0,991666 & \sigma_{w_3}^{-2} &= 0,0082645 \\ W_4 &= 0,996666 & \sigma_{w_4}^{-2} &= 0,0033228 \\ W_5 &= 0,99 & \sigma_{w_5}^{-2} &= 0,0099 \end{aligned}$$

We obtain:

$$\begin{aligned} W &= \frac{W_1 + W_2 + W_3 + W_4 + W_5}{5} = 0,9909996 \\ \sigma_w^{-2} &= \frac{\sigma_{w_1}^2 + \sigma_{w_2}^2 + \sigma_{w_3}^2 + \sigma_{w_4}^2 + \sigma_{w_5}^2}{5} = 0,0089087 \end{aligned}$$

We calculate the dispersion coefficients on each layer and we obtain:

$$\begin{aligned} CV_1 &= 11,63\% , CV_2 = 10,05\% , \\ CV_3 &= 9,17\% , CV_4 = 5,78\% , CV_5 = 10,05\% \end{aligned}$$

So the population is homogeneous. We have:

- average survey error:

$$\hat{\sigma}_w = \sqrt{\frac{\sigma_w^2}{n}} \cdot \sqrt{1 - \frac{n}{N}} = 0,0016348$$

- limit survey error:

$$\Delta_w = Z_\alpha \cdot \hat{\sigma}_w = 0,0032042$$

- confidence interval:

$$\begin{aligned} P(0,9909996 - 0,0032042 < p < 0,9909996 + 0,0032042) &= 95\% \\ P(0,9878 < p < 0,9942) &= 95\% \end{aligned}$$

so the share of correctly drawn documents is in the interval (98,78%-99,42%), and that of the ones incorrectly drawn in the interval (0,58%-1,22%). Multiplying by 30.000 we obtain the number of correctly drawn documents in the interval (98,78%-99,42%) and the interval for the documents incorrectly drawn (174, 366).

### 4. The typical proportional repeated survey

The advantage of the typical proportional survey compared with the typical simple survey is that the structure is the same in both collectivities (general and selected).

Taking the same example we present the structure of each group (layer) in table no. 1.

Table no. 1. The structure of each layer

The layer	The total number of	The number of observed

	accounting records (N <sub>i</sub> )	accounting records (n <sub>i</sub> )
S1	1.000	100
S2	5.000	500
S3	4.500	450
S4	2.500	250
S5	1.000	100
Total	14.000	1.400

The calculation of the sample on each layer was made by applying 10% (the sample volume from the total volume  $\langle n/N \rangle \times 100$ ) to the number of total accounting records of each layer.

We observe each layer and we obtain the following errors corresponding to accounting records:

- S1: 100; 80 lei;
- S2: 980; 1.000; 1.120; 900 lei;
- S3: 3.800; 4.200; 4.150; 3.950; 3.900 lei;
- S4: 750 lei;
- S5: 2.500 lei.

We process the data collected on each layer (in hundreds lei).

Because in the typical proportional survey the size of the sample differs from a layer to another, the average and the average of the dispersion averages will be calculated by adding the dispersions from each layer multiplied with the size of the sample of the given layer and divided to the total sample volume (Table no. 2).

Table no. 2. Processed data specific to typical proportional repeated survey

Layer	$\bar{y}_i$	$\bar{s}_i^2$	$n_i$	$\bar{s}_i^2 \cdot n_i$
S <sub>1</sub>	0,018	0,01607	100	1,6076
S <sub>2</sub>	0,08	0,79856	500	399,28
S <sub>3</sub>	0,444	17,6058	450	7922,611
S <sub>4</sub>	0,03	0,2241	250	56,025
S <sub>5</sub>	0,25	6,1875	100	618,75
Total	0,19592	-	1.400	8998,273

The average was calculated as it follows:

$$\bar{y} = \frac{\bar{y}_1 \cdot n_1 + \bar{y}_2 \cdot n_2 + \bar{y}_3 \cdot n_3 + \bar{y}_4 \cdot n_4 + \bar{y}_5 \cdot n_5}{n} = 0,19592857$$

$$\bar{s}^2 = \frac{899827377}{1.400} = 6,420195$$

We calculate the dispersion coefficients on each layer and we obtain:

$$CV_1 = 704\% , CV_2 = 1117\% , CV_3 = 945\% ,$$

$$CV_4 = 1578\% , CV_5 = 995\%$$

Because the dispersion is very large on each layer, it won't be applied the stratified survey, or the population will be stratified based on another criterion.

The observation will be made in connection with the incorrect accounting records too and we obtain:

Layer	S1	S2	S3	S4	S5
Incorrect records	3	6	6	3	3

We process the data collected on every layer as it follows:

$$W_1 = 0,97 \quad \sigma_{w_1}^{-2} = 0,0291$$

$$W_2 = 0,988 \quad \sigma_{w_2}^{-2} = 0,011856$$

$$W_3 = 0,98666 \quad \sigma_{w_3}^{-2} = 0,013162$$

$$W_4 = 0,988 \quad \sigma_{w_4}^{-2} = 0,0011856$$

$$W_5 = 0,97 \quad \sigma_{w_5}^{-2} = 0,0291$$

$$W = \frac{W_1 \cdot n_1 + W_2 \cdot n_2 + W_3 \cdot n_3 + W_4 \cdot n_4 + W_5 \cdot n_5}{n(1.400)} = 0,985$$

$$\sigma_w^{-2} = \frac{\sigma_{w_1}^{-2} \cdot n_1 + \sigma_{w_2}^{-2} \cdot n_2 + \sigma_{w_3}^{-2} \cdot n_3 + \sigma_{w_4}^{-2} \cdot n_4 + \sigma_{w_5}^{-2} \cdot n_5}{5} = 0,0147392$$

We calculate the dispersion coefficients and we obtain:

$$CV_1 = 17,59\% , CV_2 = 11,02\% ,$$

$$CV_3 = 11,63\% , CV_4 = 11,02\% ,$$

$$CV_5 = 17,59\%$$

The population is homogenous, so we will apply the stratified survey. We obtain:

- average survey error:

$$\hat{\sigma}_w = \frac{\bar{\sigma}_w}{\sqrt{n}} = 0,0032446\delta$$

- limit survey error:

$$\Delta_w = Z_\alpha \cdot \hat{\sigma}_w = 0,00635957$$

- confidence interval:

$$P(0,985 - 0,00636 < p < 0,985 + 0,00636) = 95\%$$

$$P(0,97864 < p < 0,99136) = 95\%$$

so the population of accounting records correctly drawn is in the interval (97,86%-99,14%) and the one of those incorrectly drawn is in the interval (0,86%-2,14%). Multiplying by 14.000 we obtain the interval (13.700, 13.880) for the accounting records correctly drawn and for the ones incorrectly drawn (120, 300).

## 5. The typical proportional unrepeated survey

Taking the same example, the formulas of

the three indicators are the same but corrected with the coefficient  $\sqrt{1 - \frac{n}{N}}$ .

Because up until now we saw that the dispersion is very large inside the layers, the stratified survey is not recommended in the audit of the size of error in the documents and accounting records. We can try another stratification which can lead to a better homogeneity inside the layers.

In the case of the number of accounting records incorrectly drawn, we obtain:

– average survey error:

$$\hat{\sigma}_w = \frac{\sigma_w}{\sqrt{n}} \cdot \sqrt{1 - \frac{n}{N}} = 0,00292$$

– limit survey error:

$$\Delta_w = Z_\alpha \cdot \hat{\sigma}_w = 0,0057236$$

– confidence interval:

$$P(0,985 - 0,0057236 < p < 0,985 + 0,0057236) = 95\%$$

$$P(0,9793 < p < 0,9908) = 95\%$$

so the share of accounting records correctly drawn is in the interval (97,93%-99,08%) and the one of those incorrectly drawn in the interval (0,92%-2,07%). Multiplying by 14.000, for the accounting records correctly drawn we obtain the interval (13.710, 13.871) and for the ones incorrectly drawn the interval (129, 290).

### 6. The typical optimal repeated survey

We will apply this type of survey only in the audit of the number of documents and accounting records incorrectly drawn because, as it has been shown, the typical survey is not applicable in the audit of the size of error from documents and accounting records.

We exemplify the typical optimal survey taking the same example with the accounting records from the typical proportional repeated survey example (Table no. 3, Table no. 4).

Table no. 3. Survey data

Layer (i)	Number of accounting records (N <sub>i</sub> )	Number of accounting records (n <sub>i</sub> )	Standard deviation ( $\bar{\sigma}_i$ )
S <sub>1</sub>	1.000	100	0,17058722
S <sub>2</sub>	5.000	500	0,10888526
S <sub>3</sub>	4.500	450	0,11472576

S <sub>4π</sub>	2.500	250	0,10888526
S <sub>5</sub>	1.000	100	0,17058722
<b>Total</b>	<b>14.000</b>	<b>1.400</b>	

Table no. 4. Determining the sample

Determining the sample volume on layers for typical optimal survey		
$N_i \cdot \bar{\sigma}_i$	$\frac{N_i \cdot \bar{\sigma}_i}{\sum_{i=1}^k N_i \cdot \bar{\sigma}_i}$	$n = \frac{n \cdot N_i \cdot \bar{\sigma}_i}{\sum_{i=1}^k N_i \cdot \bar{\sigma}_i}$
170,58722	0,101899	143
544,4263	0,325209	455
516,26592	0,308388	432
272,21315	0,162605	227
170,58722	0,101899	143
1.674,08	1	1.400

We observe each layer depending on the size of the optimal sample and we obtain the following number of incorrect accounting records (corresponding to each layer):

Layer	S1	S2	S3	S4	S5
Incorrect records	4	5	5	3	3

We process the data on each layer as it follows:

$$W_1 = 0,972028 \quad \sigma_{w_1}^{-2} = 0,02718956$$

$$W_2 = 0,989011 \quad \sigma_{w_2}^{-2} = 0,01086824$$

$$W_3 = 0,988426 \quad \sigma_{w_3}^{-2} = 0,01144$$

$$W_4 = 0,986784 \quad \sigma_{w_4}^{-2} = 0,01304134$$

$$W_5 = 0,979021 \quad \sigma_{w_5}^{-2} = 0,02053888$$

$$W = \frac{W_1 \cdot n_1 + W_2 \cdot n_2 + W_3 \cdot n_3 + W_4 \cdot n_4 + W_5 \cdot n_5}{n} = 0,9857143$$

$$\sigma_w^{-2} = \frac{\sigma_{w_1}^{-2} \cdot n_1 + \sigma_{w_2}^{-2} \cdot n_2 + \sigma_{w_3}^{-2} \cdot n_3 + \sigma_{w_4}^{-2} \cdot n_4 + \sigma_{w_5}^{-2} \cdot n_5}{n} = 0,01405191$$

We calculate the dispersion coefficient:

$$CV = \frac{\sigma_w}{W} \cdot 100 = 1,425\% , \text{ so the population}$$

is homogenous. We obtain:

– average survey error:

$$\hat{\sigma}_w = \frac{\sigma_w}{\sqrt{n}} = 0,003168134$$

– limit survey error:

$$\Delta_w = Z_\alpha \cdot \hat{\sigma}_w = 0,00620954$$

– confidence interval:

$$P(0,9857143 - 0,00620954 < p < 0,9857143 + 0,00620954) = 95\%$$

$$P(0,9795 < p < 0,9919) = 95\%$$

so the share of accounting records correctly

drawn is in the interval (97,95%-99,19%) and the share of the incorrect ones is in the interval (0,81%-2,05%). We multiply by 14.000 and we obtain the number of accounting records correctly drawn in the interval (13.713, 13.887), and the ones incorrectly drawn in the interval (113, 287).

### 7. The typical optimal unrepeated survey

Taking the same example, the formulas of the calculated indicators are the same, only the average survey error and limit survey error are corrected with the coefficient

$$\sqrt{1 - \frac{n}{N}}$$

We will have:

– average survey error:

$$\hat{\sigma}_w = \frac{\sigma_w}{\sqrt{n}} \cdot \sqrt{1 - \frac{n}{N}} = 0,00300555$$

– limit survey error:

$$\Delta_w = Z_\alpha \cdot \hat{\sigma}_w = 0,0058909$$

We can see that for the same data the average error and limit error is smaller than in the case of the repeated survey.

– confidence interval:

$$P(0,9857143 - 0,0058909 < p < 0,9857143 + 0,0058909) = 95\% \\ P(0,9798 < p < 0,9916) = 95\%$$

so the share of accounting records correctly drawn is in the interval (97,98%-99,16%) and the one of the incorrect ones is in the interval (0,84%-2,02%). Multiplying by 14.000 we obtain the number of correct accounting records in the interval (13.717, 13.882) and the number of the incorrect ones in the interval (118, 283).

### 8. Conclusions

The conclusions that can be drawn after applying the typical survey in the audit of documents and accounting records would be:

- the choice of stratification criteria will be made taking into account the particularities of the audited company;
- it is preferred to choose the typical proportional survey instead of the typical simple survey for the companies where, after the stratifying resulted layers with significantly different volume units (for example: three layers of 1.000, 3.000, and 200 de units). In all cases, the typical optimal surveys insure a more accurate representation

of the layers in sample;

– the typical unrepeated survey provides more accurate results than the typical repeated survey (the results are almost equal in both types of survey – repeated and unrepeated – if the volume of the sample is smaller than 10% from the total population volume);

– the size of the sample can be determined:

- by the researcher, who has to combine the interfering practical aspects with the intuition;
- with the formula, if the survey error (average or limit) is known from previous estimations or if it can be run a pre-investigation in order to calculate this error.

– the stratification has to be made so that each layer has a population as homogenous as possible. The homogeneity of the population can be calculated by using the dispersion coefficient (the population is homogenous if  $CV < 35\%$ ). If the dispersion coefficient exceeds 35%, it is recommended to choose other stratification criteria;

– the audit of the size of error in documents and accounting records has some particularities: because of the fact that within every company the accounting operations are correct (95%) it results a very large dispersion compared to the average of the sample, so the dispersion coefficient will be large, the precision parameter exceeding the threshold of 5% acceptable for the survey to be considered representative. In order to avoid this situation the researcher will split the size of error in groups on equal intervals. For example, if the size of error is between 100 and 3.000 lei, an example of splitting on intervals would be:

$$[0 - 500), [500 - 1.000), \dots [2.500 - 3.000]$$

The researcher has to make sure that each interval has at least one corresponding unit (preferably as many as possible).

### 9. References

- [1] Baron, T., Anghelache, C., Țițan, E., *Statistică*, Ed. Economică, București, 1996;
- [2] FIC & CSIAA, *Manual de reglementări internaționale de control al calității, audit, revizuire, alte servicii de asigurare și servicii conexe*, CAFR, București, Ediția 2012;

- [3] Jaba, E., *Statistică, ediția a 3-a*, Ed. Economică, București, 2002;
- [4] Jaba, E., Robu, I. B., Robu, M. A., Reducerea costurilor de estimare a denaturărilor contabile pe baza folosirii sondajului de clustere, *Audit Financiar*, 12(114), 2014, pp. 21-30;
- [5] Ofileanu, D., Chiriac, S.C.V., Possibilities of Using Simple Random Survey in Audit, *Ovidius University Annals, Series Economic Sciences*, 15(1), 2015, pp. 866-871.

## Capital Market Efficiency in CEE Countries

Dumitru-Nicușor Cărăușu  
“Alexandru Ioan Cuza” University of Iași  
[nicusor@live.com](mailto:nicusor@live.com)

### Abstract

*This paper examines if the capital markets from Bulgaria, Czech Republic, Poland, Romania, Slovakia and Hungary were efficient in the weak form between January 2002 to September 2015. We use an autocorrelations test, a runs test, and variance ratios tests, performed on the daily return of the most important stock indices in the selected markets.*

*Our results indicate that neither of our markets follows exactly the random walk model. Instead we find a partial efficiency in certain markets. While the autocorrelation test and unit root tests reject information efficiency, the runs test finds the Slovakian market efficient, while the variance tests indicate weak market efficiency in Slovakia, Hungary, Poland and Czech Republic. In the case of Bulgaria and Romania we find no evidence of market efficiency in either test.*

*This suggest, that in all our countries the historical data could be used to predict future assets price.*

**Key words:** market efficiency, weak form of efficiency, emerging markets

**J.E.L. classification:** G11, G14, G15

### 1. Introduction

The Efficient Market Hypothesis (hereafter EMH) is one of the cornerstones in modern financial theory and practice portfolio management. A market is deemed efficient if its prices reflect all the available information, limiting the possibility of predicting future price movements.

Weak-form market efficiency asserts that assets prices reflect all the available historical information making it impossible to predict evolution of prices from past market data such as history of prices or trading volume. Meanwhile, the semi-strong form of

efficiency implies that the market reflects all the information regarding public availability of information like past prices, earnings and current statements making fundamental analysis irrelevant, while the strong form implies that the market price reflects both public and private information, limiting the effectiveness of insider information [1]. Therefore, in an efficient capital market, the pricing mechanism is able to ensure that resources are channeled from savers only in highly efficient investments, which ultimately allows for a better capital allocation and economic development [2].

Despite the abundant economic studies in weak form efficiency [2], many of them focus only on developed economies [3], [4], while the studies for emerging markets have miss-matching results [2], [7] mainly due to analysis period, different types of methodology [7], [19] or focus only on single country [5], [6], [7]. In the case of Central and Eastern European (hereafter CEE) countries, the miss-matching results are furthermore limited by the relative short period of analysis that doesn't take into account further developments [7], [14], [15].

The study aims to provide additional insight into the efficiency of emerging countries capital markets. We believe this issue is specifically important for: investors, financial analysts, policy makers and supervisors. While investors reach out to the market as place where the price reflects information efficiency, financial analysts view the market as place where you can achieve profits when trading. This two opposite points of view need to be considered by policy makers and supervisors because the effective efficiency of a market is highly dependent on its regulatory and monitoring framework.

In our opinion, the analysis of market efficiency for CEE countries is even more adequate due to the specifics of the economic, institutional and regulatory

framework. In order to achieve our goal, we will use a wide array of instruments to test for market efficiency such as: autocorrelation test, runs test, unit root test, and four different variance ratios tests.

The rest of this paper is organized as follows: section 2 marks the literature review, section 3 presents the data, section 4 presents the methodology, while section 5 presents the empirical results and section 6 concludes.

## 2. Literature review

EMH states that abnormal systematic returns cannot be obtained systematically, because all the available information is already included in the current stock price [1]. The inability to predict future price movements in an efficient market allows for a better evaluation of assets prices and channels new investments only to performing investments, and improves capital allocation and economic development [2]. Thus testing, the efficiency of a capital market is important for: investors, financial analysts, policy makers and supervisors.

Ever since its inception the EMH testing has been the key focus of developed economies at first [1], [9], [10], but in later years emerging market efficiency testing grew in importance [8], [2], [7]. This development was accompanied by the ever involving methods of testing market efficiency, from the simple autocorrelation test [1] and general time series test [9] and especially stochastic tests [10] in earlier work to purpose built tests for market efficiency like variance ratios test [11], [12], [13], or even econophysics tests adapted from other sciences [8].

The development of emerging capital markets and testing methodology of EMH, were accompanied by an increasing number of empirical studies with mismatching results with respect to time, country or methodology. For a recent review of efficiency testing, in emerging markets [2] provides a recent summary while [7] summarizes recent work in CEE countries.

In the earlier work regarding CEE capital markets [14] finds that between 1995 and 2000 the capital markets from Czech Republic, Hungary and Poland were not efficient in the weak form, based upon

weakly series and autocorrelations, unit root test, variance ratios test, as well as ARIMA and GARCH test. The only test that confirmed that the analyzed markets were efficient was Granger causality test.

In a multiple country study [15] finds that the capital markets from the Czech Republic, Hungary, Poland and Russia were not efficient in the weak form while Greece, Slovakia and Turkey followed random walks. The main test used in the analysis were autocorrelations test, run tests and variance ratio test.

In the case of Baltic states for 1.02.2002–03.01.2009 [16] using upon unit root tests, and GARCH testing, finds that neither of the Baltic states capital markets were efficient in the weak form.

In a multiple country study regarding efficiency of post-communist countries in CEE [7] finds that with the exception of Bosnia and Herzegovina all the other capital markets were inefficient during January 2008 – December 2010. Based upon unit root tests, run test, variance ratio test, filter rules and January effect [7] finds that: Bulgaria, Bulgaria, Croatia, Czech Republic, Estonia, Georgia, Hungary, Kazakhstan, Latvia, Lithuania, Former Yugoslav Republic of Macedonia, Moldova, Montenegro, Poland, Romania, Russia, Serbia, Slovakia, Slovenia, and Ukraine were partially efficient similar to what [8] expected in emerging markets.

In the case of Romania, previous work indicated that the market was inefficient in the early stages mainly due to lack of investors and a stable risk free rate [5], it improved in efficiency as the European integration process was ongoing [6], but it marked a reduction in efficiency during the crisis [7].

Based upon the theoretical and empirical results we derive our main hypothesis:

$H_1$ : *CEE capital markets are inefficient in the weak form.*

## 3. Data

The data used in our analysis are the daily returns of the most important indices in our analyzed countries as follows: SOFIX – Bulgaria, PX – Czech Republic, WIG – Poland, BET – Romania, SAX – Slovakia, and BUX – Hungary.

Table 1. Descriptive statistics

Indices	BET	BUX	PX	SAX	SOFIX	WIG
N	3422	3438	3453	3383	3408	3447
Mean	0.000650	0.000313	0.000261	0.000237	0.000388	0.000370
Median	0.000620	0.000425	0.000724	0.000000	0.000485	0.000621
Max	0.145765	0.131769	0.123641	0.118803	0.083878	0.060834
Min	-0.119018	-0.126489	-0.161855	-0.148101	-0.113600	-0.082888
Std. Dev.	0.016220	0.015765	0.014333	0.011921	0.013374	0.012501
Skewness	-0.216568	-0.110690	-0.535777	-0.855545	-0.504276	-0.396998
Kurtosis	13.12778	9.465967	17.23170	21.10747	11.74095	6.504957
Jarque-Bera	14651.79	5996.121	29305.84	46630.19	10932.56	1854.939
Prob.	0.000000	0.000000	0.000000	0.000000	0.000000	0.000000

Source: Author calculations

The period of analysis is January 2002 – September 2015. The source of our data are the websites of the analyzed capital markets.

In testing the weak form of efficiency will use log normal returns of the daily the mentioned indices determined as depicted in equation (1):

$$R_t = \ln \left( \frac{P_t}{P_{t-1}} \right)$$

Where:  $R_t$  – is the daily return,  $P_t$  and  $P_{t-1}$  – are the prices at the time  $t$  and  $t - 1$ .

The descriptive statistics of our analyzed data depicted in table no. 1, indicates average positive growth rate for all analyzed capital markets. Because none of our distribution is normally distributed according to the Jarque-Bera test we need to take extra-caution with respect to certain weak form efficiency tests.

#### 4. Methodology

In our analysis, we will use the following tests for the weak form efficiency: autocorrelation test, runs test, unit root test, and four variance ratios test.

1. *Autocorrelation test* identifies the relationship between the price of the current assets with respect to the price in previous period. In general, the autocorrelation test indicator for a series  $Y$  and a lag  $k$  is determined as in equation (2). In order for a capital market to be efficient in the weak form, the autocorrelation indicator for an individual lag  $\rho_k$ , shouldn't be statistically significant for any lag  $k$ , considering the

average return  $\bar{r}$ , and the current return  $r_t$ , for every single value in our entire series  $N$ .

$$\rho_k = \frac{\sum_{t=1}^{N-k} (r_t - \bar{r})(r_{t+k} - \bar{r})}{N-k} \div \frac{\sum_{t=1}^N (r_t - \bar{r})^2}{N} \quad (2)$$

2. *Run test* are non-parametric tests, that follow successive trading days that ended up in a rise or fall. By comparing the random  $R$ , simulated values  $m$ , with the standard deviation of  $\sigma_m$  to the  $Z$  simulations from equation (3) we can assess if a capital market is efficient. If the  $Z$  function is positive and statistically significant then we accept weak form efficiency, and reject the hypothesis otherwise.

$$Z = \frac{R - m \pm 0,5}{\sigma_m} \sim N(0,1) \quad (3)$$

3. *Unit root test* allows the testing of market efficiency, by comparing the evolution of the indicator to a random walk process. We use the Augumented Dickey Fuller test ADF [17] with a constant and trend as in equation (4). In order to accept weak form efficiency using the ADF test we need to reject the null Hypothesis that the series has unit root.

$$\Delta y_t = \phi y_{t-1} + \beta + \gamma t + \sum_{t=1}^p \delta_i \Delta y_{t-1} + \varepsilon_t \quad (4)$$

4. *Variance ratios tests* are specifically designed test for detecting weak form efficiency. In our analysis we will use several variance test, with specific characteristics and advantages that all imply rejection of the test



in order to confirm weak form efficiency.

a) *The Lo and Mackinley variance test* [11] which compares the empirical  $VR(q)$  value for each individual lag to the value of 1 as in equation (5). If the obtained value is not statistical significant then we accept weak form efficiency, otherwise we reject it.

$$z(q) = \frac{VR(q) - 1}{\sqrt{v(q)}} \sim N(0,1) \quad (5)$$

b) *The Chow Denning significance test (CD)* [12] compares the multiples test values  $VR(q)$  to a studentized maximum modulus (SMM) distribution with  $m$  and  $T$  degrees of freedom. In our test, we will use the bootstrap version of the CD test proposed by [18] depicted in equation (6) due to better treatment of small samples.

$$CD_1 = \sqrt{T} \max_{1 < j < m} |M_2(k_j)| \quad (6)$$

c) *The Wright signs and ranks variance tests* proposed by [13] offers better results to the classic variance test [11], in condition of heteroscedasticity for the sign-based test, while the rank-based test under low-size distortion under heteroscedasticity. We use the [19] method of estimating a multiples test values, for the equation (7) in rank test  $R_j(k)$  and equation (8) for the sign tests  $S_j(k)$ .

$$R_j(k) = \left( \frac{(Tk)^{-1} \sum_{t=l}^T (r_{jt} + \dots + r_{jt-k+1})^2}{T^{-1} \sum_{t=1}^T r_{jt}^2} - 1 \right) \left( \frac{2(2k-1)(k-1)}{3kT} \right)^{-\frac{1}{2}} \quad (7)$$

$$S_j(k) = \left( \frac{(Tk)^{-1} \sum_{t=l}^T (s_{jt} + \dots + s_{jt-k+1})^2}{T^{-1} \sum_{t=1}^T s_{jt}^2} - 1 \right) \left( \frac{2(2k-1)(k-1)}{3kT} \right)^{-1/2} \quad (8)$$

## 5. Empirical results

The autocorrelation test results depicted in table no. 2 reveals that current level of prices in our six countries is linked with the level

attained in the past. Because all of the Q-statistics coefficient are statistically significant at 1% level, we can conclude that in our analysis period none of the markets followed a random walk model, thus all of our markets are informational inefficient in the weak form.

Table no. 2: Autocorrelation results

Lag	1	2	5	10
BG	0.128*** (55.48)	0.120*** (104.2)	-0.001*** (137.2)	0.054*** (165.8)
CZ	0.057*** (11.16)	-0.068*** (27.02)	0.034*** (43.46)	0.022*** (46.11)
PL	0.083*** (23.65)	-0.022*** (25.36)	0.008*** (26.92)	0.016*** (29.78)
RO	0.105*** (37.85)	-0.022*** (39.51)	0.008*** (41.09)	0.021*** (54.16)
SK	-0.063*** (13.47)	0.032*** (17.02)	0.008*** (19.16)	0.036*** (30.67)
HU	0.047*** (7.482)	-0.049*** (15.58)	0.024*** (35.65)	0.018*** (59.04)

Notes: First row is the coefficient, second row in the parenthesis the Q-Stat. \*\*\*, \*\*, \* denotes significant at 1%, 5% and 10%.

Source: Author calculations

While the autocorrelations results are quite sensitive it the absence of normality, the runs test are more robust with respect to sample composition, so we can argue that the results of the runs test from table no. 3 are more adequate.

Table no. 3: Run test results

Test	N>0	N<0	N-real	Z
BG	1591	1798	1552	-5.731*** (0.000)
CZ	1624	1829	1694	-0.937 (0.349)
PL	1681	1766	1757	1.144 (0.253)
RO	1610	1812	1556	-5.148 (0.000)
SK	1316	2067	1678	2.491** (0.013)
HU	1711	1729	1723	0.102 (0.918)

Notes: First row is the coefficient, second row in the parenthesis is the probability of the Z run test function score. N>0 is the number of days with increase. \*\*\*, \*\*, \* denotes significant at 1%, 5% and 10%.

Source: Author calculations

Our estimates indicate that the only the Slovakian capital market follows a random walk model with a probability of 95%, while in the case of Poland and Hungary event though the value of the Z function is positive it's not statistically significant, so the evidence of efficiency it's marginal. The rest of the analyzed capital markets are inefficient in the weak form according to the runs test.

With respect to the results of the unit root from table no. 4, the efficiency of all our capital markets it's rejected according to the ADF test, but with reserves regarding the lack of normally of our sample who can invalidate the results of the test in certain environments.

Table no. 4: Unit root test

Test	1%	5%	10%	ADF
BG	-3.432	-2.862	-2.567	-24.36*** (0.000)
CZ	-3.960	-3.411	-3.127	-43.38*** (0.000)
PL	-3.960	-3.411	-3.127	-54.03*** (0.000)
RO	-3.960	-3.411	-3.127	-52.70*** (0.000)
SK	-3.960	-3.411	-3.127	-62.13*** (0.000)
HU	-3.960	-3.411	-3.127	-28.54*** (0.000)

Notes: First row is the coefficient, second row in the parenthesis is probability of the ADF test. \*\*\*, \*\*, \* denotes significant at 1%, 5% and 10%.

Source: Author calculations

The variance VR test from table no. 5 indicate some interesting aspect regarding capital market efficiency in CEE countries. While none of our markets exhibit, information efficiency for the second lag in the case of Czech Republic, Hungary, Slovakia and to some extent Poland, the EHM is confirmed for higher lags than 4. This implies that the present results are correlated with past result in the short term, because in the long run they follow a random walk model. This implies partial efficiency in the weak form.

The joined significance variance ratio results from table no. 6 offers some miss-matching results. While the initial Chow-Denning CD<sub>1</sub> joined significance test, rejects

the EMH in the weak form, the other tests indicates partial informational efficiency.

Table no. 5: Lo and Mackinley VR test

Lag	2	4	8	16
BG	1.127*** (3.419)	1.137*** (4.832)	1.566*** (5.307)	1.912*** (6.197)
CZ	1.056*** (3.330)	0.992 (-0.24)	0.987 (-0.24)	1.019 (0.253)
PL	1.082*** (4.857)	1.111*** (3.505)	1.156** (3.107)	1.206* (2.757)
RO	1.105** (6.184)	1.128*** (4.013)	1.152** (3.025)	1.309*** (4.115)
SK	0.939*** (-3.53)	0.932** (-2.08)	0.911* (-1.73)	1.011 (0.147)
HU	1.046*** (2.734)	1.003 (0.094)	1.014 (0.295)	1.016 (0.213)

Notes: First row is the coefficient; second row is value of the Z-statistic for heteroscedasticity estimates. \*\*\*, \*\*, \* denotes significant at 1%, 5% and 10%.

Source: Author calculations

Our results indicate, that Hungary is the most informational efficient capital market in our sample, with Chow Denning bootstrap test CD<sub>2</sub>, Joint rank JR<sub>1</sub> and Joint sign JS<sub>1</sub> confirming the random walk model. Meanwhile for Czech Republic the CD<sub>2</sub> and JS<sub>1</sub> indicate information efficiency, while for Poland only JS<sub>1</sub>. This miss-matching results, can be attributed to the ability of the joined sign and rank test, to detect finer differences under the presence of heteroscedasticity.

Table no. 6: Variance ratio join tests results

Test	CD <sub>1</sub>	CD <sub>2</sub>	JR <sub>1</sub>	JS <sub>1</sub>
BG	12.07*** (163.5)	-6.137***	11.07*** (134.4)	9.744*** (96.42)
CZ	3.330*** (38.87)	1.272	2.403** (18.30)	1.561 (6.249)
PL	4.857*** (26.10)	3.790***	2.194* (8.484)	2.057 (5.819)
RO	6.184*** (58.30)	3.361***	6.772*** (1.115)	5.128*** (41.27)
SK	3.536*** (26.88)	2.694**	5.040*** (39.52)	8.139*** (109.6)
HU	2.734** (26.69)	1.409	1.133 (5.053)	0.747 (2.815)

Notes: First row is the coefficient, second row in the parenthesis is Wald Chi-Square statistics. \*\*\*, \*\*, \* denotes significant at 1%, 5% and 10%.

Source: Author calculations

## 6. Conclusions

The aim of this paper was to determine if the capital markets from Bulgaria, Czech Republic, Poland, Romania, Slovakia and Hungary, were efficient in the weak form from January 2002 to September 2015. We employed a wide array of tools for testing market efficiency: autocorrelation test, runs test, unit root test, and variance ratios tests.

Our results indicate that neither of our markets follows exactly the random walk model similar to what [8] suggested. Instead we find partial evidence for the Slovakian market in the runs test, while the variance ratio tests indicate a partial efficiency in Slovakia, Hungary, Poland and Czech Republic. In the case of the Bulgaria and Romania we find no evidence of market efficiency.

This suggest, that in all our countries the historical data could be used to predict future asset price, making technical analysis viable.

Despite our best efforts, our study does have some limits, regarding period of analysis and the efficiency of the instruments. By employing additional testing tools such as stochastic or econophysics tests different results could be attained.

## 7. Acknowledgements

Funding for this work was provided by the European Social Fund through the Sectoral Operational Programme Human Resources Development 2007-2013, project number POSDRU/187/1.5/S/155656 "Support for PhD Students in economics science domain".

## 8. References

- [1] Fama, E., "Efficient Capital Markets: A Review of Theory and Empirical Work", *The Journal of Finance*, 25 (2), 1970, pp. 383-417.
- [2] Nurunnabi, M., "Testing weak-form efficiency of emerging economies: a critical review of literature", *Journal of Business Economics and Management*, 13(1), 2012, pp. 167-188.
- [3] Urquhart, A. "The Euro and European stock market efficiency", *Applied Financial Economics*, 24(19), 2014, pp. 1235-1248.
- [4] Borges, M., R., "Efficient market hypothesis in European stock markets", *The European Journal of Finance*, 16(7), 2010, pp. 711-726.
- [5] Dragotă, V., Mitrica, E., "Emerging capital markets' efficiency: The case of Romania", *European Journal of Operations Research*, 155, 2004, pp. 353-360.
- [6] Dragotă, V., Stioian, A., Pele, D., Mitrică, E., Bensafa, M., "The development of the Romanian Capital Market: Evidences on Information Efficiency", *Journal of Economic Forecasting*, vol. 6 (2), 2009, pp. 147-160.
- [7] Dragotă, V., Țilică, E., V., "Market efficiency of the Post-Communist East European stock markets", *Central European Journal of Operations Research*, vol. 22(2), 2014, pp. 307-337.
- [8] Lim, KP., Brooks R., "The evolution of Stock Market Efficiency over time: a survey of empirical literature", *Journal of economic Surveys*, 25 (1), pp. 69-108.
- [9] Fama, E., "Efficient Capital Markets II", *The Journal of Finance*, 46 (5), 1991, pp. 1575-1617.
- [10] Fama, E., "Market efficiency, long-term returns, and behavioral finance", *Journal of Financial Economics*, 49 (3), 1998, pp. 283-306.
- [11] Lo, A.W, MacKinlay, A.C., "Stock market prices do not follow random walks: evidence from a simple specification test", *Review of Financial Studies*, 1 (1), 1988, pp. 41-66.
- [12] Chow, K., Denning, K., "A simple multiple variance ratio test", *Journal of Econometrics*, 58, 1993, pp. 385-401.
- [13] Wright, J., (2000), "Alternative variance-ratio tests using ranks and signs", *Journal of Business and Economic Statistics*, 18, 2000, pp. 1-9.
- [14] Gilmore, C.G., "Random walk and efficiency test of Central European equity market", *Managerial Finance*, 29 (4), 2003, pp. 42-61.
- [15] Hassan, K.,M., Haque, M., Lawrence, S., "An empirical analysis of emerging stock markets of Europe", *Quarterly Journal of Business and Economics*, 45 (1), 2006, pp. 31-52
- [16] Aktan, B., Korsakiene, R., Smaliukiene, R., "Time-varying volatility modelling of Baltic stock markets", *Journal of Business Economics and Management*, 11 (3), 2010, pp. 511-532.
- [17] Dickey, D.A., Fuller, W.A., "Distribution of the estimators, for autoregressive time series with a unit root", *Econometrica*, 49, 1981, pp. 1057-1072.
- [18] Kim, J., "Wild bootstrapping variance ratio test", *Economics Letters*, 92, 2006, pp. 38-43
- [19] Kim, J., Shamsuddin, A., "Are Asian stock markets efficient? Evidence from a new multiple variance ratio test", *Journal of Empirical Finance*, 15, 2008, pp. 518-532.

## Annual Financial Statements and the Financial Information Supply

Genu Alexandru Căruntu,  
*Faculty of Economics, „Constantin Brâncuși” University of Târgu Jiu*  
[cgenuc@gmail.com](mailto:cgenuc@gmail.com)  
Loredana Ciurlău  
*Faculty of Economics, „Constantin Brâncuși” University of Târgu Jiu*  
[lcurlau@yahoo.com](mailto:lcurlau@yahoo.com)

### Abstract

*Financial statements are a structural representation of the financial position, financial performance and cash flows of an enterprise. Their main objective is to provide useful information to a wide range of users as possible in order to enable economic decisions. The information provided allows making projections about future cash flows, in particular relating to the maturity and the likelihood of their realization. Financial situations can be compiled the results obtained from the use of economic resources managed by the management company.*

*Financial statements must present the financial position at the end of the period, the net result of the period, change in capital and reserves along the year, cash-flow, dividends distributed during the year and notes the annexes.*

*In Romania, according to the new regulations, financial statements consist of: the balance sheet, the profit and loss account, statement of changes in equity, cash flow statement, accounting policies and explanatory notes.*

**Key words:** cash-flow, annual reports, the balance sheet, the profit, loss account

**J.E.L. classification:** E44

### 1. Introduction

Users of information published in the annual summary documents are numerous and varied population forms, but it is generally accepted that the most extensive and important category of potential beneficiaries form investors. The idea of trying to satisfy the need for direct financial

information to all users accounts, real or potential, is a difficult, if not impossible.

The recognition of the legitimate interests of the various groups of users raises the question whether it is desirable to produce comprehensive annual accounts, including all potential information useful.

On the other hand, there is also another problem, related to educational level of users of information, content and presentation of the annual accounts cannot be reduced to the lowest common denominator, adding and conflicts of interest between different user groups, fueled by their heterogeneity.

The increasing internationalisation of financial markets means that increasingly more to ensure better comparability of the accounts of companies from different countries. In fact, the differences between financial statements determined in accordance with international rules by each country, identified gaps in the accounting information of some of them, and sometimes national rules variations from one year to another, as do the comparisons become impossible as, for example, comparing the average productivity of staff between groups of countries and those from another country when in fact, companies from these countries are not even constrained to indicate in their annual reports any livestock personally, nor the costs with them.

Investors and financial analysts must understand financial statements of foreign companies whose actions they would like to buy them. They would also be able to compare the financial statements of companies located in different countries and to ensure that the information is relevant. For example, in terms of valuation, the practice used in most countries is "FIFO method", while in England it is using the concept of "the smallest value between FIFO cost and

net realisable value", while in the us the concept of "the smallest value between the cost-FIFO and current replacement cost".

Therefore, numerous intergovernmental bodies, including the European Union, are concerned with the protection of investors of different spheres of influence. At the same time, companies that wish to have access to certain national markets of capital will be required to prepare financial statements that correspond to the practices in that country. The benefits are felt most poignantly by companies who wish to have access to international financing[1].

Financial statements are a means of communication, the aim of which is to provide financial information clearly and effectively, and in the most simple and easy as possible, without diminishing the relevancy and reliability and without grow unnecessarily size financial statements.

## 2. Purpose financial statements

The purpose financial statements is to provide a structured financial representation relating to the financial position and the transactions carried out by the enterprise. In these circumstances, the financial statements should provide information about the financial position, performance and cash flows of an enterprise, information that is useful to a wide range of users in making economic decisions.

Also, financial statements are intended to indicate the results achieved by the management company, including how it has used the resources entrusted to it.

To achieve this purpose, the financial statements should provide information to enable users to perform predictions on the future of cash flows, in particular relating to the maturity and their probability[2]. Financial statements are useful as far as inducing a vision or a bridge to the future that is whether it helps users to evaluate the ability of the company to generate future cash flows, as well as the time and certainty of their generation.

In an economic environment which is in a constant dynamism, annual accounts no longer can shape in the past.

**The objective** of financial statements is to provide information about the financial position, performance and changes in

financial position of the undertaking which are useful to a wide range of users in making decisions. Financial statements present, too, and the result of the management company by its management, including the management of the resources entrusted to it.

Financial statements should help users in decision-making of investment, to provide information relating to the economic resources of the enterprise as well as to the commitments made in the consideration of those resources, as well as any change in their value.

Accounting information does not provide a direct assessment of the enterprise, but it is useful, helping those who carry out such assessments.

Financial statements allow assessment of how the administration of the enterprise and its resource management by managers.

Financial statements allow owners to control how the leadership of the enterprise managed resources, and third parties to ensure compliance with the contractual commitments of the undertaking.

Information concerning the financial position are given, firstly, the balance on the outcome, through the profit and loss account, and the information on changes in financial position through some distinct situations[3].

The financial position of the undertaking is defined by the economic resources it controls of the financial structure of the assets, liabilities and equity, liquidity and solvency and economic values of its ability to adapt to changes in the environment in which it operates.

Any management that sets out performance management must accept financial statements forecast. From the methodological point of view, the financial statements forecast is based on analysis of past financial accounting and is preparing the budget of the Enterprise System. That's why those accounts take information about the past financial accounting that correlates and upholds the preliminary information retrieved in the budgets. The relevance of the information required and the interim financial statements prepared and presented during the financial year, quarterly or half yearly. Currently, all companies are required to submit a set of financial statements, whose composition varies depending on the size of the enterprise. Societies of people (who are

not in the public interest and whose capital is made up of shares) should present a balance sheet and a Profit and loss Account. Capital companies is mandatory the additional presentation of an annex, as well as an annual report, as defined by the Fourth Directive. You can specify that the annual report should provide all the information necessary for submitting an authentic-looking images of society, but is not part of the financial statements.

Normalized accounting plan items are: financial statements, including the shape and format of the chart of accounts, general (the system of accounts, the name, the symbol, the content and function of the clearance of accounts) as well as the Organization of accounting documents, registration procedures, validation and control of all economic operations. An important element that characterizes the financial situation of a company's own capital, is defined as the residual interest in the assets and liabilities.

By reference to the relationship of computation (assets-liabilities) can support the emergence and recognition of capital only when conditions are met regarding the recognition of economic resources (assets) and obligations (debts) [4]. This explains the absence of criteria for the recognition of capital assets and debt acknowledgement: generating capital and recognition in this situation to establish specific criteria would be redundant.

Own funds shall be assimilated to some extent the obligations in that it is the obligation of the company to investors, but his assessment is not reflected in the need to take decisions, but it is a result that characterizes the net wealth of society, the rights of investors in the company's activity. The definition provides integrated recognition of own funds.

The character of residual element that emerges from the definition, it is only applied for the valuation of equity, in the sense that the value at which it is recorded in the balance sheet depends on the valuation of assets and debts and should not minimize the importance of its recognition. Users of financial statements need to have information enabling a better understanding of the financial position and performance of the enterprise.

A motivation to treatment of capital maintenance concepts as a basis for drawing up the financial statements starts from the premise that any valuation basis used must be capable of maintaining equity financing capacity, so that after each exercise, the funds invested in the form of capital to be reconstructed in order to maintain its original value.

### **3. Financial reporting**

The current trend of financial reporting is characterized by the presentation of financial and accounting information in outlook, stating that they must help users to estimate the future cash flows of the enterprise. In order for the information to be oriented to the future, it is not enough to be used in future-oriented values and currently active.

Simplistic at first, the necessary information of the business environment has become increasingly complex with the development of social life, some enterprises with increasingly more complex and require a modern governance. Accounting has always been the most adapted tool of understanding, analysis and organization of the information relating to transactions and events businesses[5].

Those who complete, audited financial reports and uses must choose and evaluate accounting alternatives. The central role of the decision-making process leads us to the criteria which must govern the accounting elections, considering that the best choice is the one that, in the context of costs, produce information with explicable given the greatest use of all possible alternatives.

The current practice, which must extend, the use of frameworks, enabling a higher quality of information by establishing criteria for reporting. Necessary information to users depends on the priorities of action, of interest to a particular situation or experience to users. Financial information obtained in a lower cost limit the effect must be intelligible, but especially useful decision making, therefore, must be meaningful. Those who draw up the financial statements must start with the reality that users have adequate knowledge of economic and accounting and can study the information presented with skill, and the structure of financial and accounting information satisfies

the conditions of aggregation and classification. Providing such information already analysed in financial statements providing relevance to users as it recorded the diversity of decisions and thereby minimizes the likelihood of misinterpretation, virtually assuring a guide to interpretation. Users of the information in the financial statements should be able to understand the information presented without undue effort. Investors, lenders, managers and other users of financial accounting information are interested in not just the net asset value of the company at any given moment, but also the changes that have affected the net situation. Such changes shall take the results of the current transaction, and incidental events, those that make up the activity of the enterprise or those occurring beyond the control of management activity or of the entity itself.

General purpose financial statements must provide a true and fair view of the results and the financial position of a company at the end of the financial year, providing useful information to a broad category of users. Depending on their size and nature, the events that occur between the balance sheet date and the date on which the signed financial statements may also be included in the financial statements or in the notes. Users who are interested to have access to such information that affects decisions concerning activity of the company in question.

The values to be included or shown in the general purpose financial statements are determined using professional reasoning. Decisions are based on certain factors, such as: how significant are the information and whether they should be presented separately in the balance sheet or profit and loss account, either in the notes to the financial statements, as well as how users are interested in[6].

#### 4. Conclusions

Over financial reporting process, importance has been attributed mainly to providing information through the balance sheet and the profit and loss account, and the fight for supremacy has always given between the two components of the financial statements, but it was never ruled out the possibility of providing additional and

detailed information through other components of financial statements. In conditions of globalization requirements concerning reporting of annual accounts, have supported the flexibility of reporting by means of variable models of financial statements.

#### 5. References

- [1] Caraiani C., Lungu C.I., Dascălu C., *Repoziționarea raportății financiare. Studii și cercetări*, Editura ASE, București, 2012.
- [2] Cotleț D., Megan O., *Situațiile financiare ale întreprinderii*, Editura Orizonturi Universitare, Timișoara, 2003.
- [3] Deaconu A., *Valoarea justă. Concept contabil*, Editura Economică, București, 2009.
- [4] Gorgan C., *Convergența contabilă internațională. Implicații asupra raportării financiare*, Editura ASE, București, 2013.
- [5] Jianu I., *Evaluarea, prezentarea și analiza performanței întreprinderii*, Editura CECCAR, București, 2007.
- [6] Popescu V. L., Nistor C. Gh., Caruntu G. A., *Gestiunea financiară a întreprinderii și aplicații matematice în economie*, Editura Sitech Craiova, 2007.

# Various Approaches to Economic Development and Fiscal Policy for the European Union Member Countries

Maria Felicia Chirculescu

University "Constantin Brâncuși" Targu Jiu, Romania,  
[chirculescu\\_felicia@yahoo.com](mailto:chirculescu_felicia@yahoo.com)

Gabriela Bușan

University "Constantin Brâncuși" Targu Jiu, Romania,  
[gabriela\\_busan@yahoo.com](mailto:gabriela_busan@yahoo.com)

## Abstract

*Taking decisions on the establishment of new taxes or the modification of existing ones take into account various aspects of the needs of the State, the level of development, but in many countries, increasing coordination of decisions in the sphere of taxation and adapting national tax systems to social needs changing goals remain. Each country is characterized by specific stages of economic development, with different evolutions of budgetary revenue and expenditure systems, and a variety of tax systems. In this work are summarized different approaches to economic development, tax system, tax policy, etc., and various reforms undertaken within them.*

**Key words:** economic development, tax system, tax policy

**J.E.L. classification:** G32, O23

## 1. Introduction

The concept of economic development and the growth occupies an important place in the theories. The concept of economic development complements the growth by including qualitative aspects of the structure of the economy, of the society, technological progress, etc. Both concepts, development and growth of importance of increasingly high economic literature, the analysis found links that may appear between these phenomena and unemployment, inflation, fiscal and budgetary policies etc.

By analyzing the economic development of a country or region, can track changes in the economy, can do research on poverty in the area concerned, the influences of the actions of individuals and / or businesses on

the environment, in order to thus creating strategies to consider removing harmful influences exerted on the environment, and policies aimed at eradicating poverty in the area.

The strategy of the EU Sustainable Development states that sustainable development is an objective underlying the policies and activities of the European Union and relates to the continuous improvement of quality of life and increased welfare for present and future generations, promoting dynamic economy characterized by full employment labor and a high level of education, healthcare, environmental protection measures etc. The overall aim of the renewed EU strategy is to identify and develop actions to enable the EU to achieve a continuous improvement in the quality of life for present and future generations through the creation of sustainable communities able to manage and use resources efficiently.

Over time, due to the changes that have occurred, economists trying to explain how to develop an economy, they set out various theories that explain the obstacles to economic growth, how they could be overcome, the measures State may adopt measures to support sustainable development etc.

Between economic development and fiscal strategy adopted by a country should be closely connected, each stage of development characterized by specific elements, and the objectives should always be included and the support for encouraging the economy.

Văcărel Iulian [8] provides an overview of fiscal policy - budget in Romania, being analyzed, among others, issues such as public finance reform, public revenues and expenditures of Romania (compared with



other countries), and the link between finance and real economy.

Ocean [5] provides an analysis of the link between economic development and fiscal policy for the 21 European countries, and followed the relationships between changes in GDP per capita tax burden at the national level, the share of total public expenditure in GDP and the share budget balance in GDP.

Ocean [5] considers that economic development can be influenced through fiscal policy measures and highlights the importance of: the capacity of governments to assess the economic situation, to choose the right tool for intervention and to anticipate correctly the effects in the economy thanks to its use.

Each country is characterized by specific stages of economic development, with different developments in budget revenues and expenditures, as well as a variety of tax systems.

The development of a country is a complex process, fiscal policy adopted in one time or another by the State could present an influence on it. After Easterly and Rebelo [3] between the development and structure of fiscal of countries there is a strong link: poor countries rely heavily on taxes on international trade, while income taxes are important only in developed economies, and investment in transport and communications are correlated with economic growth.

At European Union level there are differences in terms of taxation, which emphasizes the development of their taxes represents important elements of measures adopted by each state.

Economic theories have shown that each country is characterized by specific stages of economic development marked by various trends in revenue and spending, unemployment, inflation etc.

Regarding the fiscal reforms undertaken by the Member States of the European Union withhold tax practice ideas presented (Carone and Salomaki, [2]), namely: they have adopted measures to reduce the tax burden on labor; also, there were measures to reduce marginal tax rates and other such measures.

Referring to Romania's accession to the European Union has brought us new challenges in various fields, membership is giving us a number of benefits, but also new

obligations. Each European Union country is free to choose its own tax system and measures taken in this sphere must respect Community rules.

Văcărel [7] stated that developing a strategy to Romania on taxes requires knowledge of the experience of developed countries and those with economies in transition, but points out that it would be dangerous to copy the tax system or regulations of a country, because there are not two countries that have identical economic, social conditions etc.

## 2. Approaches to fiscal policy

Turning to fiscal policy within the European Union, the European Commission's strategy is to ensure priority for fiscal policy to eliminate tax obstacles to cross-border business in the case. The European Union Member States are free to choose the tax system which it considers appropriate and any proposal for EU action in this field will have regard to the principles of subsidiarity and proportionality.

Based on several works of the European Commission, the European Council adopted in December 1997 a package scheme (Tax Package) which aimed at combating harmful tax competition within the European Union. The main elements referred to in that package were represented by: a code of conduct aimed at eliminating tax regimes harmful to business and measures to ensure a minimum level of taxation of savings and elimination of taxes on cross-border payments of interest and royalties between associated enterprises .

At EU level fiscal policy consists of two components: direct taxation, which remains the responsibility of Member States, and indirect taxation, which has effects on free movement of goods and the freedom to provide services. As regards direct taxation, Member States have adopted measures to prevent tax evasion and double taxation.

The fiscal policy will ensure that competition is not distorted between Member States in the internal market phenomenon due to differences between rates and indirect tax systems.

Tax policy (C. Corduneanu, [1]) all decisions having a fiscal policy taken by the deciding factor in order to ensure financial

resources to finance public needs and the realization of finality of economic-social conditions in which the economy operates factors real or objective, which is not only cyclical trend.

Taxes and fees resources and decisions affecting the use of income tax payers, be they legal or natural persons. The income taxes can resize economic household income and revenue agencies, but their perception ensure state resources.

Fiscal measures that are promoted aimed, in fact, certain targets. Thus, if it aims at stimulating employment and creating new jobs, there should be measures such as exemptions or reductions in taxes for companies for a certain period of time. In the same way if they are to proceed in a certain period + investment promotion, should the measures taken to assist taxpayers in adopting a behavior in this direction.

The revenues from taxes is important for the state, because it may be used to support various activities, but the system of taxation should be designed so as not to adversely influence the willingness of taxpayers to work or pursue an economic activity etc.

State may adopt measures to influence the direction of the economy through taxes brought modifying, these measures are part of the fiscal policy of a certain country specific, depending on the stage of development and is based on the domestic and international situation.

As shown in Table No. 1 is observed that in the year 2014, the gross domestic product, expressed in euro per capita is presented in Luxembourg to a level of 87,600 euros, Denmark 45 700 euro, Ireland 41,000 euro in Bulgaria 5,900 euros. The average in the UE28 in 2014 was 27,400 euros. Regarding Romania, in the year 2014 level registered below the average being 9,300 UE28.

*Table No. 1*  
*GDP per capita, EUR / market prices – 2014*

GDP per capita			
2014			
Belgium	35.900	Lithuania	12.400
Bulgaria	5.900	Luxembourg	87.600
Czech Republic	14.700	Hungary	10.600
Denmark	45.700	Malta	18.600
Germany	35.400	Netherlands	39.300

Estonia	15.200	Austria	38.500
Ireland	41.000	Poland	10.700
Greece	16.200	Portugal	16.700
Spain	22.400	<b>Romania</b>	7.500
France	32.200	Slovenia	<b>18.100</b>
Croatia	10.200	Slovakia	13.900
Italy	26.500	Finland	37.600
Cyprus	20.400	Sweden	44.400
Latvya	11.800	UK	34.900
UE 28	27.400		

Source: [www.europe.eu.int](http://www.europe.eu.int), Eurostat Statistics

In the EU-28 there are countries with different degrees of development and standard of living, each having a fiscal policy reflected in the law, and the share of taxes in GDP vary from country to country; 2012, No. 1 being Denmark, Belgium 2nd and 3rd France (Table No. 2).

Tabel nr. 2.

The share of indirect, direct taxes and social contributions in GDP

*Table No. 2*  
*The share of indirect, direct taxes and social contributions in GDP -year 2012*

- % -					
Indirect, direct taxes and social contributions in GDP					
2012/Place					
Belgium	45,4	2	Lithuania	27,2	28
Bulgaria	27,9	27	Luxembourg	39,3	8
Czech Republic	35	16	Hungary	39,2	9
Denmark	48,1	1	Malta	33,6	18
Germany	39,1	10	Netherlands	39	11
Estonia	32,5	21	Austria	43,1	7
Ireland	28,7	23	Poland	32,5	20
Greece	33,7	17	Portugal	32,4	22
Spain	32,5	19	<b>Romania</b>	<b>28,3</b>	<b>25</b>
France	45	3	Slovenia	37,6	12
Croatia	35,7	13	Slovakia	28,3	24
Italy	44	6	Finland	44,1	5
Cyprus	35,3	15	Sweden	44,2	4
Latvya	27,9	26	UK	35,4	14
UE 28	36,3				

Source: [www.europe.eu.int](http://www.europe.eu.int), Eurostat Statistics

Total taxes (including social) refers to direct taxes, indirect taxes and actual social contributions. Direct taxes are taxes on income or wealth plus capital taxes, including probate fees or donations, which

are represented by income tax, corporation tax, other taxes on income and on capital. Indirect taxes are taxes on production and imports, namely value added tax, excise and flat consumption tax, other taxes on products, other taxes pr production. Actual social contributions are paid by the employer and employees, the self-employed etc, being represented social decontribuțiile employers' actual social contributions of employees, self-employed social security contributions etc.

According to the data sheet no. 2 Pinder taxes (including social security contributions) in GDP for 2012 was 36.3%. Conversely countries: Denmark, Belgium and France was Lithuania, Bulgaria and Latvia. As regards Romania, the record was 7 percentage points lower than the average UE28.

### 3. Conclusions

The development of a country represents a complex process, fiscal policy adopted in one time or another by the state could present an influence on it. In specialized literature is pointed out that between the development and budgetary-fiscal structure of countries there is a strong connection, that means that poor countries rely heavily on taxes on international trade, while income taxes are only important economies developed and investment and transport, communications are correlated with economic growth. Countries that have big taxes have also in generally higher expenditure, the share of budgetary revenues in GDP increases with income. As income increases, the share of taxes on international trade decreases in total income, increasing the share of income taxes. High-income countries have significant costs to the healthcare system and programs developed by national security.

The level of taxes are important elements when designing policies and measures on taxation, being known that there may be situations where high levels of taxes can be for business, reason to look for locations where they are presented at a lower level.

Countries within the European Union differs regarding taxation, which emphasizes the level of their development, taxes and fees are important elements of measures adopted by each state.

Researchers conducted the study aims at identifying issues in the economy, then the state can choose between strategies required to achieve the desired path that the macroeconomic indicators. The state can influence the course of the economy through appropriate policies to boost investment, savings, support of competition by measures to encourage entrepreneurs.

### 4. Bibliography:

- [1]. Coorduneanu C., The tax system in the science of finance, Codecs Publishing, Bucharest, 1998
- [2]. Carone G., Salomäki A., Reforms in Tax-Benefit Systems in Order to Increase Employment Incentives in the EU, Economic Paper, No. 160, ECFIN 511-EN-01, 2001.
- [3]. Easterly W., Rebelo S., Fiscal Policy and Economic Growth: an Empirical Investigation NBER Working Paper Series, Working Paper No. 4499, 1993.
- [4]. Nicolaescu Eugen, Comparative Taxation, Publisher Pro Universitaria, 2012
- [5]. Ocnean A.S., Empirical Study on fiscal policy connection-economic development 2006
- [6]. Smith, Adam, The Wealth of Nations, Vol. II, Publisher Universitas, Chisinau, 1992
- [7]. Văcărel I., Economic and financial policies of yesterday and today, Economic Publishing House Bucharest, 1996
- [8]. Văcărel I., Fiscal and budgetary policy in Romania 1990-2000, Expert Publishing House Bucharest, 2001
- [9]. [www.europe.eu.int](http://www.europe.eu.int)

# The Role of Foreign Banks in Ensure Performance the Romanian Banking System

Loredana Ciurlău,

*Faculty of Economics, „Constantin Brâncuși” University of Târgu Jiu*  
[lciurlau@yahoo.com](mailto:lciurlau@yahoo.com)

Genu Alexandru Căruntu,

*Faculty of Economics, „Constantin Brâncuși” University of Târgu Jiu*  
[cgenuc@gmail.com](mailto:cgenuc@gmail.com)

## Abstract

*Although most banks report high levels for overdue and doubtful loans, the overall quality of these portfolios fall favorable European context, the degree of provisioning of bad loans in Romania is higher than that reported by many other countries in Europe, situation due to the fact that Romanian banks have toxic assets held in the portfolio.*

*The banking sector continued to record financial soundness indicators in the positive spectrum, good capitalization and having financial results.*

*The efficiency of the banking system is directly linked to business volumes consistent growth based primarily on attractive products in terms of both cost and less on conquering new market segments. The persistence of global crisis leads to reduced economic activity so that domestic macroeconomic developments have an important impact on the health of the financial system.*

**Key words:** banking system, bank restructuring, financial intermediation, banking supervision, profitability.

**J.E.L. classification:** F21, G28

## 1. Introduction

Profitability is one of the key sources of capital, generating an adequate indicator of the competitive position of a banking institution and the quality of its management, allowing a bank to maintain a certain risk, providing protection from short-term problems, known as a healthy banking system is built on the profitable banks

adequately capitalized and [1].

A framework for effective performance review encompasses a number of factors such as: the organization of appropriate enabling the allocation of income and expenditure on units of activity in relation to the various business lines, products or market segments of a bank; an internal system of pricing for the purposes of quantification of the contribution of the different units of the bank's activity results and incorporation of the elements of risk in the context of performance appraisal.

## 2. Profitability - the main objective of bank management

Profitability is the ability of a business to generate profit, as a management tool for quantifying the profitability of activities, both in forecasting and to implement them [2].

As a determinant of development and strengthening the bank's position in the banking system, profitability can be analyzed with the help of revenue and expenditure, as a tool for implementing the bank's strategy and as a tool of management accounting contributes to follow the development costs and their correlation with revenues at the bank.

From the management point of view, one can determine profitability of the territorial units of the bank, profitability of bank customers, each of these segments are considered profit centers, where the bank's profitability is a result of the summation customer profitability or profitability of products and services promoted by the bank.

Given that banking was introduced some elements of decentralization, as well as

higher credit ceilings for operational units, marketing strategies, Romanian banks organized activity centers or units and sub-regional, which have resources and drives cost, efficiency or inefficiency analyzes of operative units. In the literature it is estimated that an area which should be given importance is to determine more precisely the profitability at the plant and territorial units, using indicators enabling a hierarchy of units depending on the efficiency, liquidity, solvency risk in pursuit of development banking units and conversion, taking into account the competitive environment existing basis of possible customers, the volume of products and services, the level of interest income and commissions and the size of resources that can be attracted.

Depending on management objectives, a profit center can take the form of a bank branch or a department of the central bank, which through its activities generate direct revenue, a product, a service or a bank customer and cost center can it is considered a department of the central bank engaged in the business does not generate revenue.

The two pillars of the banking system, respectively solvency and liquidity remains high in the Romanian banking system, with a significant prudential space for new funding (figure no. 1):

Figure no. 1., The two pillars of the banking system



The Romanian banking system has demonstrated structural stability and during 2014 achieved optimization of loan portfolios through a comprehensive cleaning of balance sheets and extending credit, during 2015, a rate almost similar to the one before crisis.

The solvency ratio remained at a high level of 18.07% in June 2015, while the minimum threshold established under the European regulatory framework is 8%. Romanian banking system is among the few

banking sectors in the European Union did not need during the crisis backed by public funds.

The Romanian banking system includes 40 credit institutions.

The structure of the Romanian banking sector by the end of 2014 includes two banks with capital or State majority, three institutions with majority private equity, 25 banks with majority foreign equity, 9 branches of foreign banks and a credit cooperative property. The share of foreign-owned assets in institutions with total assets of the Romanian banking system has risen to 83% in December from 90% to the level of December 2014.

Regarding the shareholders' origin function of assets, the banks with Austrian capital hold a market share of 36,7 %, followed by the banks with French capital of 13,3 % and those with the Greek capital of 12,4 %.(figure no. 2).

Figure no. 2

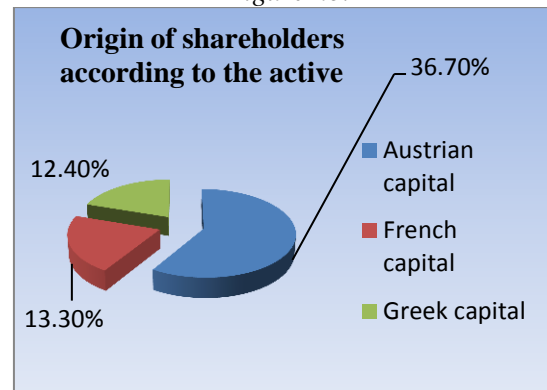

Source: www.arb.ro

The priorities of the banking industry pertain to maintaining the banking sector's role as main financier of Romania's economy while providing for the stability and credibility of this banking sector. The Romanian banking sector finances mainly the Romanian economy, providing about 90% of the total funding granted by the Romanian financial sector.

The banking sector can be a strong pillar for the economy, but it needs certainty as regards laws and regulations and a level playing field for all. For banks, the risk aversion of the legal framework could put pressure or generate risks in another sector of the economy.

### 3. Advantages resulting from the preponderance of foreign banks in Romania

Foreign banks that have entered Romania certainly had a beneficial role in the development of local economies through lending to households and firms. This is due to the access to cheaper sources of financing from parent banks or other banks in the group, and a greater propensity to take risks if they are fully covered. Good reputation enjoyed by multinational banks exert a pull on customer attraction which, in conjunction with quality products and services and competitive rates practiced led to their expansion in terms of market share and their profitability high. Moreover, these observations arising from the Romanian banking system performance analysis and foreign banks components are compatible with the perception that the Romanian banking system managers have towards foreign and local banks.

The main *advantages* resulting from the preponderance of foreign banks in Romania (figure no. 3):

*Figure no. 3., Advantages resulting from the preponderance of foreign banks in Romania”*

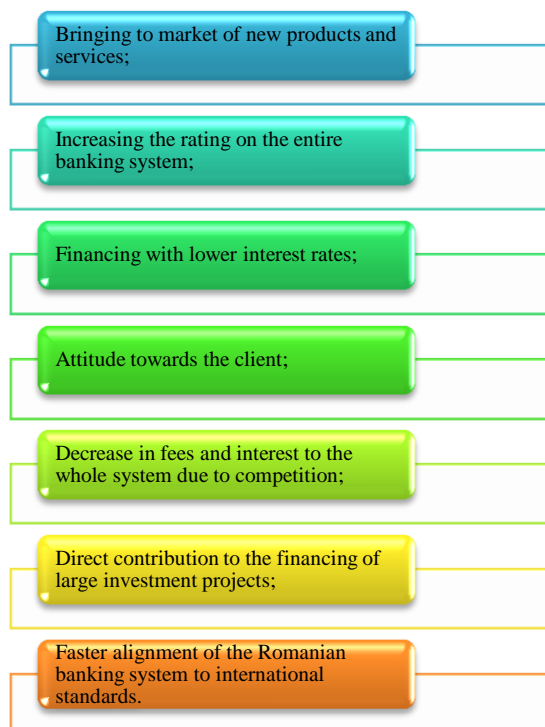

Foreign banks are considered more profitable, so the involvement especially in

the most profitable activities - government and corporate funding, but also because of increased sales oriented more aggressive commercially. Multinational banks benefit from a higher share of sales oriented staff, equipment and IT support, but support in the group to which they belong.

Foreign banks are perceived as bringing disadvantages, related primarily to strong competition and perspectives of concentration through mergers and acquisitions, which over time may lead to oligopoly positions.

Strengthening the banking sector is a continuous process, which depends inter alia, the state of the financial system and macroeconomic situation of the country. Banking sector.

Europe has experienced a period of restructuring in the 1990's, which was characterized by a wave of unprecedented mergers and acquisitions banking in most countries, and resulted in creating banking groups, business development and cross-border mergers and acquisitions cross-sectoral. Financial globalization, deregulation and market integration, adopting a single currency, technological and financial innovations, increasing shareholder value, were major drivers behind the wave of bank mergers and acquisitions. Financial system The European Union is characterized by the emergence of cross-border mergers because groups banking within developed countries were motivated by a desire to take over the smaller banks other countries to improve efficiency, to enter new markets in order to increase Aggregate market share and profits. Although, since 2010, the mergers and acquisitions in Europe has slowed due to the global economic recession and the collapse of financial markets, banking consolidation process continued.

The financial crisis of 2008 has left its mark on banking institutions in the country. Various factors, such as continuing difficulties in obtaining cheap resources from parent banks, rising unemployment and the uncertainties of the labor market, reducing Market income and population (which reduced lending and brokerage, but affected the recovery of claims against real economy), falling exports and reducing investment, lowering the value of

real estate assets and risks Banking contagion etc. put in difficulty, to varying degrees, all market players bank Romanian. The first signs of a return to banking, support the resumption of companies

Romania parent banking entities are beginning to see the end of 2011, But neither the time of completion of this work, the recovery is not complete. It is another facet, more risky, less spectacular and certainly undesirable processes expansion large global players, the negative influences propagated in the world economy initiated by a crisis have been exaggerated actions and behavior, greedy, development without measure, the large financial groups. It is a fact that Romania, like many other countries of the world can't ignore, and the Romanian banking system dominated by foreign capital, must find in a coincidence of interests and respect of policies balanced and prudent risk control, the best way of development benefit of each participant, whether it comes from banks and their shareholders, the state sector economic or society as a whole.

#### 4. Conclusions

Against the background of globalization the role of foreign banks increased global permanently occupying an important position in the domestic financial intermediation. The inability of some countries to mobilize sufficient capital to support the banking activity and hence the real economy was offset by the increased role of foreign banks in the financial systems host that the entry to these markets have contributed to higher levels of capitalization and liquidity through intake capital and easier access to international financial resources.

Romania's banking industry has grown in the last two decades, playing a central role in developing the country. The banking sector has coped with the global financial crisis and has stabilized its contribution to GDP to over 30% and is now ready to enhance its role in the next phase of development of the country.

However, banks and financial institutions in Romania is currently facing a number of structural weaknesses which significantly reduces the ability to raise capital and competitiveness against their counterparts from Eastern Europe and West - thus limiting

significantly their role as catalyst for growth.

Romanian banks offer corporate customers and individuals a full range of services:

- conventional bank,
- a variety of instruments investment,
- specialized financing solutions.

Despite sustained efforts to adjust banking infrastructure market potential in Romania, trends in the cost / income ratio will not improve in the near future in Romania.

In Romania, the outlook is relatively negative and is expected to cost / income ratio will increase from 55.7% in 2013 to 59.9% in 2016. While banks in Romania are expected to further reduce costs, the banking sector is facing narrowing margins caused by lower interest rates and lower income from securities with the alignment of interest rates (Table no.1).

Table no. 1 Ratio cost / income (%)

	2010	2011	2012	2013	2014	2015	2016
Nord	50.2	48.9	49.7	50.3	49.6	48.9	48.1
Polonia	52.4	50.7	50.9	52.8	51.9	51.0	49.9
Cehia	44.0	45.0	43.9	43.0	42.3	42.0	41.7
Slovacia	54.6	49.6	61.0	56.0	54.7	54.2	54.0
Sud	52.9	52.8	60.3	59.3	67.5	59.2	59.0
Ungaria	58.6	53.8	79.7	69.3	66.4	70.0	69.1
România	51.4	55.0	58.9	55.7	57.2	59.4	59.9
Bulgaria	48.8	50.0	52.0	53.5	50.5	51.7	51.6
Croația	48.3	47.9	51.7	52.2	51.8	51.8	52.0
Slovenija	52.2	53.7	47.4	66.1	53.9	53.3	51.3

Source: Eurostat

#### 5. References

- [1]Oprîtescu M. și colectiv, *Managementul riscurilor și performanțelor bancare*, Editura Universitaria, Craiova, 2006, p. 149
- [2]Nițu I., *Principii ale profitabilității bancare*, Editura Expert, București, 2002, p. 57
- [3]Bădulescu D., *Globalizarea și băncile*, Editura Economică, București, 2007
- [4]Spulbăr C., *Management bancar – ediția a II-a*, editura Sitech, craiova, 2008
- [5]Anton S.G., *Instituții financiar-bancare internaționale*, Editura Oeconomica, București, 2013
- [6]Nițescu D.C., „*Marketing bancar*”, Editura ASE, București, 2014

\*\*\* [www.bnro.ro](http://www.bnro.ro)

\*\*\* [www.arb.ro](http://www.arb.ro)

## Efficiency of Tax Claims Collection through Foreclosure

Elena Doina Dascălu

"Spiru Haret" University, The Faculty of Economics

[doina.dascalu@rcc.ro](mailto:doina.dascalu@rcc.ro)

Laura Nasta

Bucharest University of Economic Studies, Doctoral School in Economics

[alsenasta@gmail.com](mailto:alsenasta@gmail.com)

### Abstract

*The most important way to enhance amounts collected to the state budget from taxes is to discipline tax payers, increasing voluntary compliance with tax claims statement and payment.*

*Tax claims collection can be made more efficient by concentrating the resources of debt enforcement bodies on taxpayers with a high volume of arrears (some 20% of taxpayers with outstanding debts exceeding 15,000 lei cumulate 95% of the overall arrears).*

*The enforcement of procedures to monitor taxpayers in difficulty, before they are under the insolvency procedure, so that ANAF (The National Authority for Tax Administration) may timely conduct tax inspections, order restraint measures, foreclosure, before the taxpayer's patrimony is scattered or shared among creditors, plays an important part in making tax claims collection through foreclosure more effective.*

*Promoting legislative measures to stimulate voluntary compliance with the obligation to pay tax claims would have beneficial effects on the consolidated general budget economy.*

**Key words:** foreclosure, arrears, recoverable arrears, tax claims collection

**J.E.L. classification:** E62, H32, H61

### 1. Introduction. Theoretical aspects of budget claims foreclosure

Traditionally, sovereign states have the power to establish taxes on the national

territory, to define the ways and means to collect them: *this is called taxation sovereignty.*

In the matter of taxes collection, the fiscal debt is not a usual debt and law-makers need to always find a balance between:

- the need that the Tax Administration Authority has prerogatives going beyond the jurisdiction of common law, because its competences are enforced in the general interest;

- the competitive interests of other creditors;

- the rights and obligations of the respective debtors.

It is in the interest of all citizens that the Tax Administration Authority be protected against taxpayers' insolvency, so finding a balance between the interests of all parties involved is at the centre of genuine debates in all modern states. Mention shall be made that the Tax Administration Authority is not a common creditor in any of the states of the world.

The foreclosure measures are very well delimited from the legal point of view.

A creditor may not resort to the enforcement of the foreclosure procedures on the revenues and assets of the debtor unless the law: acknowledges this right; sets the competences ceilings; defines the procedure to be followed and the sanctions to be enforced in case of failure to observe it.

In the fiscal procedural law, for general interest reasons and in order that public revenues collection be as effective as possible, the law-maker exonerated the tax body from the obligation to request of the court the issue of a writ of execution. The tax administration body itself issues a *writ of execution*, based on which it certifies the tax



liability of the taxpayer. This derogation from common law is still subject to the court of law's subsequent control.

The foreclosure bodies are tax administration bodies habilitated to manage tax claims and to enforce distraint measures, as well as to conduct the foreclosure procedure. In case debtors do not pay of their own accord the tax obligations they owe, then the competent foreclosure bodies are habilitated to enforce the foreclosure procedures, in keeping with the provisions of the Tax Procedure Code.

Budget claims foreclosure does not lapse, which means that irrespective of the period since a foreclosure act was enforced, the fiscal creditor may not be sanctioned by the enforcement of the foreclosure, while the fiscal creditor may not be sanctioned by obsolescence enforcement, as different from common law where, in keeping with the provisions of art. 697 of the Civil Proceedings Code, if the creditor let pass 6 months since the enforcement of any writ of execution without accompanying it by other prosecution acts, foreclosure lapses by the operation of law and any interested party may claim its annulment.

The new legislative modifications in the taxation field which will come into force on 01.01.2016 regulate, under art. 345 of Law 207/2015 on the Tax Procedure Code the fact that the specialised structures with competences in tax claims administration, subordinated to ANAF, are authorised, in

their capacity as attorneys in fact, to record movable securities with the Electronic Archive for Security Interests in Movable Property.

The assessment of the assets subject to foreclosure is conducted by the competent foreclosure bodies, through own expert evaluators or through independent expert evaluators. The assessment price of the debtor's assets may be updated by the foreclosure body in relation with the inflation rate.

The foreclosure procedure is conducted ex officio and, once launched, it may be suspended interrupted or may cease only in the instances provided by the Tax Procedure Code.

## 2. Situation and trend of arrears to the general consolidated budget in Romania

The trend and component parts of legal entities' arrears, as shown in Figure 1, record a significant increase in non recoverable arrears, from 24,519.00 million lei in 2007 to 61,834.00 million lei in 2014. The largest part of these arrears is accounted for by the opening of the insolvency/bankruptcy procedure by taxpayers, a situation in which foreclosure is suspended and, at the same time, the calculation of ancillary obligations is interrupted from that moment on.

Figure 1. Trend of the arrears of legal entities in the period 2007-2014 (million Lei)

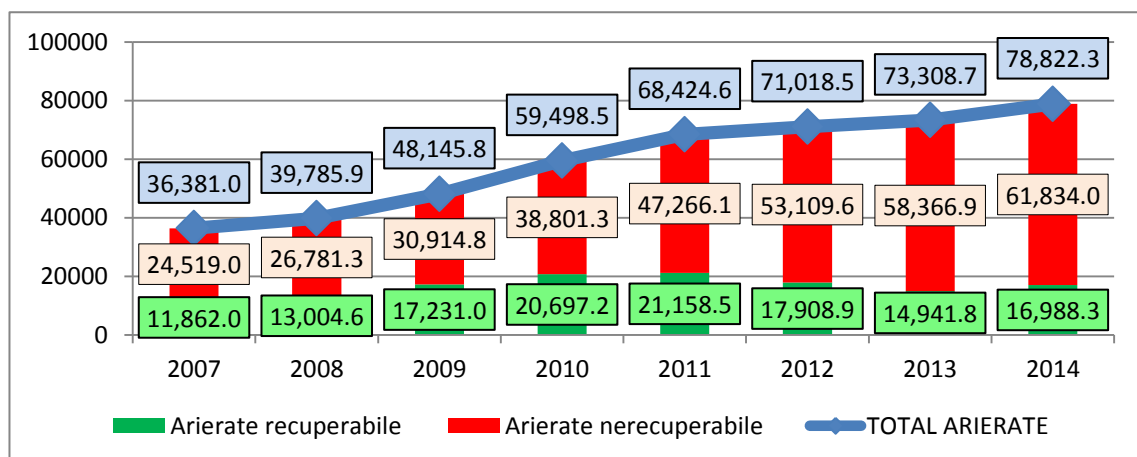

(Legend: **Green** - Recoverable arrears; **Red** - Non-recoverable arrears; **Blue** - TOTAL ARREARS)

Source: The National Authority for Tax Administration: *Tax Statistics Bulletin*, 2012-2015, [www.anaf.ro](http://www.anaf.ro)

The analysis of the data in Figure 2 reveals the fact that ANAF recorded, as of 31.12.2014, uncollected tax liabilities from economic agents of about 11.8% of the GDP, out of which recoverable arrears represent 2.5% of the GDP. In the context of the Romanian economic evolution, it can be

noticed that *the overall arrears of tax-paying legal entities* represented in 2014 11.8% of the GDP, a relatively constant level in comparison with the period 2010-2013, but *by about 4% of the GDP more than in 2008* (the year of the emergence of the economic crisis in Romania).

Figure 2. Trend of the arrears of legal entities in the period 2007-2014 (% of GDP)

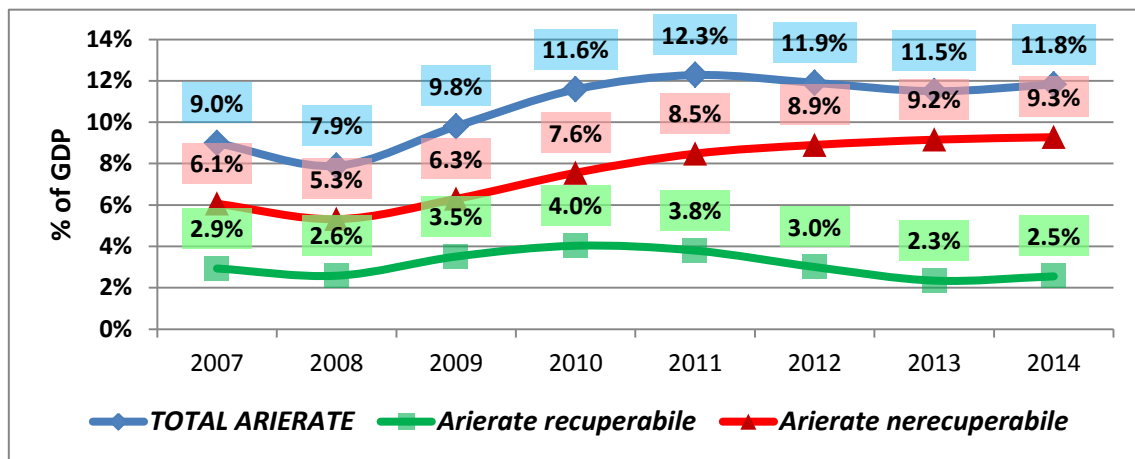

(Legend: **Blue** - TOTAL ARREARS; **Green** - Recoverable arrears; **Red** - Non recoverable arrears)

Source: The National Authority for Tax Administration - *Tax Statistics Bulletin*, 2012-2015, [www.anaf.ro](http://www.anaf.ro)

The analysis, as of 31.12.2014, of arrears according to budgetary sources for which the National Tax Administration Authority has to enforce its foreclosure competences, shows

that most of the amounts are in fact non recoverable arrears, the collection of which is doubtful (mostly, arrears of economic agents under the insolvency/bankruptcy procedure).

Table 1. Componence of arrears recorded with ANAF as of 31.12.2014, according to budget sources

Budget	Recoverable arrears (mil. lei)	Non recoverable arrears (mil. lei)	TOTAL (legal entities + individuals)
State budget	15,395.3	44,543.0	59,938.3
State social insurance budget	2,984.3	13,095.0	16,079.3
Health social insurance budget	1,046.2	3,262.5	4,308.7
Unemployment insurance budget	130.3	1,077.6	1,208.0
Public institutions budget	17.0	154.6	171.6
<b>TOTAL arrears as of 31.12.2014</b>	<b>19,573.1</b>	<b>62,132.9</b>	<b>81,705.9</b>

Source: The National Authority for Tax Administration - *Tax Statistics Bulletin*, 2012-2015, [www.anaf.ro](http://www.anaf.ro)

The data in Table 1 show that only 24% of the overall arrears are outstanding tax liabilities for which ANAF had, as of 31.12.2014, the legal right to enforce foreclosure measures, the remaining 76% of the overall arrears recorded with ANAF

representing *non recoverable arrears* (for which foreclosure has been suspended).

In the instance of the arrears recorded by legal entities as of 31.12.2014, 78.4% of the overall arrears are *non recoverable arrears* (mainly of the companies in the process of insolvency/bankruptcy), 62.2% being over 1

year old and 16.3% (about 12.8 billion lei) being non recoverable arrears recorded during 2014 (see Table 2).

In point of date of recoverable arrears of legal entities (for which, in keeping with law,

ANAF may enforce foreclosure measures) as of 31.12.2014 there existed arrears of 7.3 billion lei over one year old, while 9.7 billion lei represent recoverable arrears less than one year old.

Table 2. Situation of the collection capacity in the instance of legal entities as of 31.12.2014 – general consolidated budget

Arrears 31.12.2014 – legal entities (million lei)	Recoverable arrears legal entities		Non recoverable arrears legal entities		TOTAL	
	Amount	Total %	Amount	Total %	Amount	Total %
➤ arrears at the end of the previous year (over 1 year old)	7,296.1	9.3%	49,010.7	62.2%	56,306.8	71.4%
➤ arrears recorded during the reporting year (less than 1 year old)	9,692.2	12.3%	12,823.2	16.3%	22,515.5	28.6%
<b>Total arrears</b>	<b>16,988.3</b>	<b>21,6%</b>	<b>61,834.0</b>	<b>78,4%</b>	<b>78,822.3</b>	<b>100,0%</b>

Source: The National Authority for Tax Administration: *Tax Statistics Bulletin*, 2012-2015, [www.anaf.ro](http://www.anaf.ro)

In order to take adequate measures to counter arrears accumulation it is extremely important to establish the *origin of arrears and the factors which favoured the cascading*

*of debts to state budget.* The chart below, Figure 3, features a detailed situation of *recoverable arrears as of 31.12.2014, structured according to origin:*

Figure 3. Structure of recoverable arrears, according to origin, as of 31.12.2014

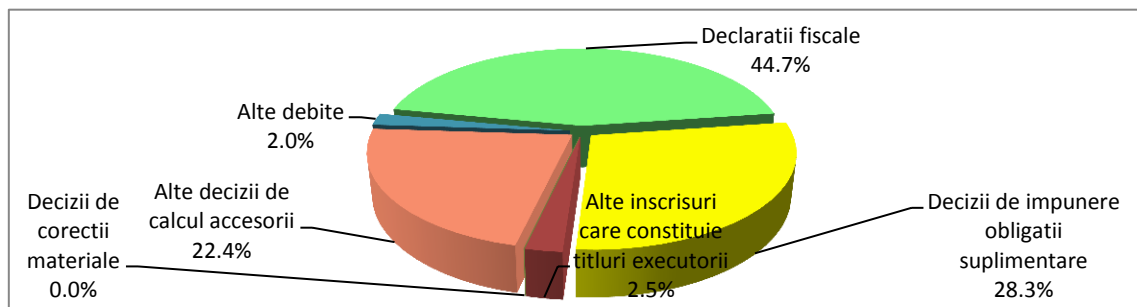

(Legend: - **Other debts** 2.0%; - **Other decisions for ancillary obligations calculation** 22.4%; - **Material corrections decisions** 0.0%; - **Other enforcement documents** 2,5%; - **Taxation decisions for additional obligations** 28,3%; - **Tax return** 44.7%)

Source: The National Authority for Tax Administration: *Tax Statistics Bulletin*, 2012-2015, [www.anaf.ro](http://www.anaf.ro)

It can be noticed that most of these amounts represent tax liabilities recorded in the tax returns submitted by taxpayers. Practically, 45% of the arrears are voluntarily declared by economic agents. Thus, failure to pay taxes and the accumulation of big arrears becomes a new form of tax evasion, involving the fact that taxpayers declare their

tax liabilities (thus not falling under the provisions of Law no. 241/2005 *on tax evasion prevention and fighting*), but they do not actually fulfil the obligation to pay taxes to the general consolidated budget. As a matter of fact, the very significant volume of non recoverable arrears (companies undergoing an insolvency/bankruptcy procedure) further confirms this fact.

The very high volume of ancillary obligations (22%) in the overall recoverable arrears shows that many of the due tax obligations not paid by economic agents are much older.

The additional amounts set by taxation decisions, following tax inspections, represent a special situation. As of 31.12.2014, some 28% of the arrears consisted in supplementary balances established by control bodies. In these instances, in keeping with the legal provisions on tax procedure, there exists the possibility to set restraint measures. In practice, countering the accumulation of such arrears should be made by joint efforts of tax

inspection and foreclosure bodies within ANAF.

In order to recover a higher percent of the arrears to the consolidated budget, it is necessary that foreclosure measures be concentrated on the areas which accumulate high arrears volumes. In keeping with the information available at ANAF as of 31.12.2014, some 31% of arrears belonged to a small number of economic agents, respectively to the large taxpayers managed by the General Directorate for Large Taxpayers Administration (DGAMC). Figure 4 below shows the detailed situation of the arrears weight pertaining to each taxpayer category of the overall recoverable arrears recorded by ANAF:

Figure 4. Recoverable arrears recorded as of 31.12.2014 (classification according to taxpayer category) - million lei

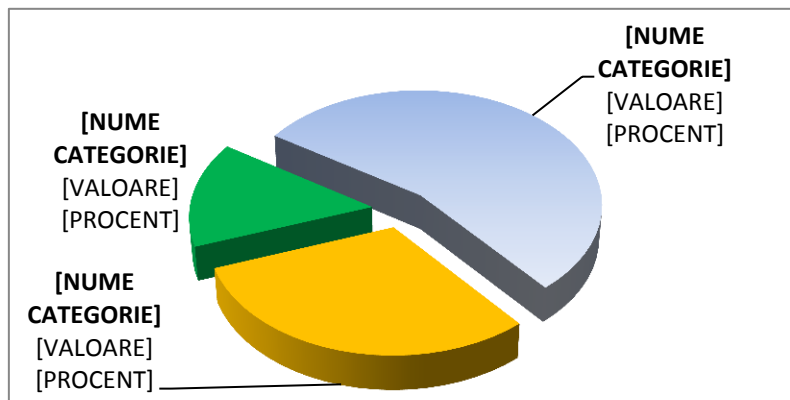

(Legend: [CATEGORY NAME] [VALUE] [PERCENT])

Source: The National Authority for Tax Administration: *Tax Statistics Bulletin*, 2012-2015, [www.anaf.ro](http://www.anaf.ro)

The tax units specially set up to ensure a more performing administration of large taxpayers to state budget, respectively DGAMC and the Public Finance Administration for Intermediate Taxpayers within each regional structure, cumulated a total of 46% of recoverable arrears recorded by ANAF.

A detailed analysis of the debtors' structure as of 31.12.2014, see Table 3, shows that 76% of the arrears represent tax liabilities of taxpayers with debts exceeding 150,000 lei. Furthermore, 18% of the recoverable arrears result from taxpayers which owed, as of 31.12.2014, taxes

amounting to 15,000 – 150,000 lei. Practically, debtors of over 15,000 lei cumulate over 95% of recoverable arrears as of 31.12.2014.

A closer look at the state budget large debtors' category reveals that most arrears recorded at ANAF belong to a small number of taxpayers (see Figure 5). Thus only 2.7% of the overall debtors recorded as of 31.12.2014 (some 11,300 taxpayers) cumulate debts of over 12.9 billion lei, that is 75.7% of the overall arrears recoverable from legal entities in ANAF record books.

Table 3. Recoverable arrears recorded by ANAF as of 31.12.2014 (classification according to taxpayers' outstanding tax liabilities volume)

	Debtors number	% in no. debtors	Arrears cumulated volume (recoverable) (mil. lei)	% in arrears volume
Arrears < 500 lei	125,154	29.6%	19.4	0.1%
Arrears 500-1.500 lei	59,079	14.0%	55.4	0.3%
Arrears 1.500-7.500 lei	110,150	26.1%	413.7	2.4%
Arrears 7.500-15.000 lei	42,498	10.1%	445.4	2.6%
Arrears of taxpayers with <b>debts between 15.000 and 150.000 lei</b>	74,404	17.6%	3,183.5	18.8%
Arrears of taxpayers with <b>debts over 150.000 lei</b>	11,357	<b>2.7%</b>	12,859.0	<b>75.7%</b>

Source: The National Authority for Tax Administration: *Tax Statistics Bulletin*, 2012-2015, [www.anaf.ro](http://www.anaf.ro)

Figure 5. Number of debtors and value of recoverable arrears recorded by ANAF as of 31.12.2014

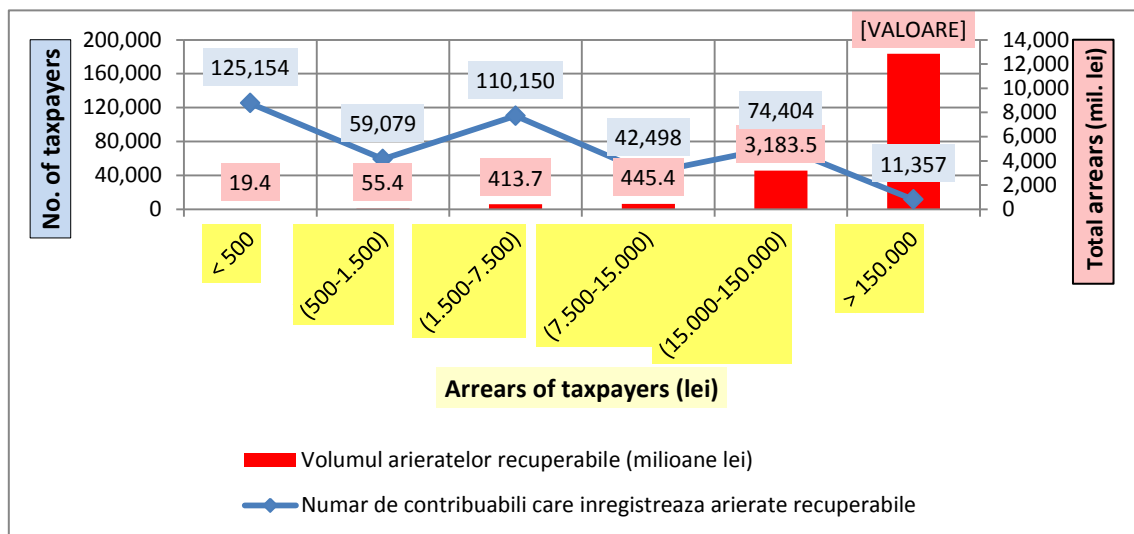

(Red - Volume of recoverable arrears (million lei); Blue - Number of taxpayers with recoverable arrears)  
Source: The National Authority for Tax Administration: *Tax Statistics Bulletin*, 2012-2015, [www.anaf.ro](http://www.anaf.ro)

Taxpayers with small debts (up to 15,000 lei), though representing most of the defaulters (about 80% of the total number of recoverable arrears debtors) only account for 5.5% of the overall arrears.

### 3. Conclusions

The arrears volume kept going up, the main reason of the increase of non recoverable arrears being the massive

insolvency of taxpayers with debts to the general consolidated budget.

The tax claim collection can be made more effective in the instance of ANAF by concentrating the foreclosure bodies' resources on high arrears taxpayers (about 20% of taxpayers with pending debts over 15,000 lei cumulate about 95% of the overall arrears).

The issue of penalties and late payment fees exemption in case pending debts were paid by taxpayers until a certain date (for

example March 31<sup>st</sup>, 2016 in keeping with an emergency ordinance promoted in October 2015 by the Government) will only create advantages for defaulting taxpayers, in the detriment of those that constantly and timely pay tax liabilities. In our opinion, the promotion of legislative measures to stimulate voluntary compliance with the obligation to pay tax liabilities would have beneficial effects on the general consolidated budget economy.

## References

- [1]. The National Authority for Tax Administration: *Tax Statistics Bulletin*, 2012-2015, [www.anaf.ro](http://www.anaf.ro);
- [2]. Ministry of Public Finance, *Public Finances and Accounting Journal*, years 2012-2015, [www.mfinante.ro](http://www.mfinante.ro);
- [3]. Dascălu, Elena-Doina, Rușanu D.R., *Public finances*, România de Mâine Foundation Publishing House, Bucharest, 2009;
- [4]. Iulian Văcărel et al., *Public Finances* 2nd Edition, Editura Didactică și Pedagogică București, 2004;
- [5]. Dascălu, Elena-Doina, Ionescu E., Burcea M.C., Tănase I., *Financial Audit at Public Entities*, Europlus Publishing House, Galați, 2012;
- [6]. Order no. 92/2003 on the Tax Procedure Code

## Accountancy and Management of Human Resources Employed on Subsidized Places - Young Graduates -

Carmen Maria Dindiri

University of Craiova, Faculty of Economics and Business Administration  
[mari.negrila@yahoo.com](mailto:mari.negrila@yahoo.com)

Cristian Drăgan

University of Craiova, Faculty of Economics and Business Administration  
[cdragano11@gmail.com](mailto:cdragano11@gmail.com)

Valeriu Brabete

University of Craiova, Faculty of Economics and Business Administration  
[vali\\_brabete@yahoo.com](mailto:vali_brabete@yahoo.com)

### Abstract

*The adequate management of human resources represents a complex process, with multiple implications at the level of any economic entity. On one hand, it is imposed to be fulfilled the managerial requirements in the field and, on the other hand, to be realized in optimal conditions under the aspect of associated costs. A convergence element in this respect can be represented by the employment of young graduates of this nature. This study aims to emphasize the main aspects imposed by the implementation of such a decision, both from the managerial point of view and in respect to the so-called accounting settlement.*

**Key words:** young graduates, human resources, subsidy, accountancy.

**J.E.L. classification:** M41, K31

### 1. Introduction

The issue regarding the employment of young graduates is of first importance, recognized on European and even on global level, and the politics for its decrease and for the stimulation of insertion on the labor market of young people differ from a country to another, depending on a series of factors such as the culture and education level or the economic or social development level.

The economic competitiveness and the general image of a country is largely influenced by the training level of the labor

force and, taking into account the differentiation in which it is considered that the apogee of the career is realized at the age of 25+ [1], we reach to the conclusion that, to invest in the human resource, when it is more trained in receiving and fructifying this opportunity, is the safer way in fighting against the rate of unemployment and the external migration.

Thus, we consider that it's beneficial to illustrate the necessity of awareness, by the employers, of the benefits brought by the employment of young graduates and, in this context, we punctuate that in addition to advantages as diminution of wage costs because of subventions received through governmental programs of stimulation of employment of young graduates, the implementation of new personnel recruitment policies from this category gives entities and image benefits, taking into account the social responsibility which devolves on it, as a component more and more conspicuous in the life of any organization.

### 2. General aspects regarding the rationalization of human resources management through subsidies

The management of human resources represents a complex process, carried out according to rules properly handed down in management, which have to consider, on one hand, the reaching of the entity's objectives and, on the other hand, the optimization of costs related to this essential component of any organization. This presupposes the

realization of a permanent equilibrium between assurance, development and keeping of human resources, within a well defined plan on the entity level, and the related costs of its implementation. During the implementation of the plan, a particular attention is granted to the recruitment and, within this process, is emphasized the efficient attraction of candidates, fact which supposes the "identification, the evaluation and the use of the right sources of procurement of candidates" [2]. Herewith, it is known the fact that such concerns are more and more conspicuous, as it takes place the development of the entity. Its evolution imposes the rigorous estimation of the number of employees needed and also the type of skills and competences required by future jobs from the organizational structure of the entity.

This decision-making process presupposes an approach on stages and, within it, a particular attention is given to the related costs, being known the fact that the human resources represents an important factor which generates expenses with major implications on the cost of entity's products and services and, as a consequence, of its financial performances.

Therefore, an efficient management in the field of human resources presupposes, among others, the careful analysis of all possibilities of reducing the wage costs, among which we find the employments according to the programs for employers' stimulation, by offering subsidies for employment of some categories considered disfavored. Between these, we can mention the employment of disabled persons, the employment of young people according to the solidarity agreements, the employers stimulation for employment of out of work persons – young graduates, employment of out of work persons over 45 years old or of out of work parents, unique supporters of single parent families, employment of out of work persons who still have 5 years until pension, the employers stimulation in order to employ scholars and students during holidays and also the stimulation of employing trainees.

As we can notice, the measures are preponderantly addressed to out of work persons and, if we focus on the labor market from the last 4 years from our country, we'll find an unemployment rate with a relatively

constant oscillation, fact which suggests that, as a whole, there is a certain degree of efficiency of insertion policies of out of work persons.

In turn, analyzing the unemployment rate on groups of age, it is found a significant ratio of young persons who are out of work persons, respectively of people with age between 16 and 24 years old, mainly caused by the employers' reticence to call on young persons, mainly given by their lack of experience and this fact generates the accumulation of an increasing number of young persons who will form a generation of out of work persons of long term. Such an affirmation is supported by the data presented in the following table.

*Table no.1 Unemployment rate on groups of age*

	2011	2012	2013	2014
<b>Total</b>	<b>7,2</b>	<b>6,8</b>	<b>7,1</b>	<b>6,8</b>
Under 25	23,9	22,6	23,7	24
25 years and over	5,7	5,4	5,7	5,5

Source: *România în cifre* (Romania in figures), 2015.

Romanian educational system annually gives, on the labor market, a number of graduates which represents about 6% of the active population and, among these, on average 66% are qualified on specializations. Although, in the year 2014, a quarter of high school and higher education graduates entered directly in unemployment status and those who got a job, about 80%, practice in other fields than those in which they were professionally trained through the studies.

In another train of thoughts, we mention the fact that, within the decision-making process previously mentioned, the analysis of wage costs is not exclusively based on economic calculations, which aim the simple summation of the expenses of this nature, but we also need to take into consideration the fact that the employer represents more than a simple component of productive factors and, as such, it is imposed that the management of human resources of the entity exceeds the rigid principles of the management of the other assets of the organization.

Taking into account those previously exposed, this study aims a succinct presentation of the management, within the entity, of human resources employed on



subsidized places, illustrating both the main advantages and disadvantages of the employment of young graduates, and the specific accounting aspects of the implementation of such policies it is presented below.

### **3. Contribution of employment of young graduates on subsidized places on the entity performances**

Active measures regulated by the Law 76/2002 (art. 80-84), aim to stimulate the employers who employ graduates of educational institutions, regardless their level (but with the condition of being authorized/ accredited according to the law), by granting subsidies, for each graduate in part, as it follows:

- a) an amount equal to the value of the social reference indicator in force on the employment date, for the graduates of the lower secondary education or of the schools of arts and crafts;
- b) an amount equal to of 1,2 times the value of the social reference indicator in force on the employment date, for the graduates of higher secondary education or post-secondary education;
- c) an amount equal to of 1,5 times the value of the social reference indicator in force on the employment date, for the graduates of higher education.

The subsidy is granted for a period of 12 months, once for each graduate and, herewith, once for each type of education graduated, with the following conditions:

- the employment agreement is concluded for an indefinite period of time;
- the employment is realized in maximum 12 months from the graduation date;
- it is stipulated the compulsoriness of keeping at the work place of the graduate, for a period of 18 months (respectively with 6 months more in respect to the period in which the subsidy is received). Contrarily, the amount of the subsidy received will be fully reimbursed;

During the 18 months, the graduates can benefit from professional training programs insured by the employer, and the expenses caused by these will be paid, upon the employers request, from the unemployment insurances budget.

Herewith, the employers who, after the completion of the 18 months, keep the work reports with the graduates, receive, for each year of continuation of the work reports (for maximum 2 years), a financial aid equal to the amount related to the social contributions due by the employers for these persons and transferred according to the law.

The active policies of this type promoted on the labor power from Romania have as purpose to increase the adaptability of active persons to the economic environment in continuing development, according to the idea that „a highly qualified labor force, with a high education level, having the capacity to adapt to new technologies and needs in change of the markets, is essential for an competitive and dynamic economy” [3].

In order to emphasize the need of awareness, by the employers, of the benefits brought by the employment of young graduates, we aim to illustrate the advantages and the disadvantages of the recruitment of personnel of this category, grouped in a manned we consider relevant, as it can be noticed.

#### **Advantages:**

##### ***Financial***

- the subsidy represents a financial incentive which allows the optimization of wage costs. Thus, during the 18 months, the employment of a young graduate, by comparison to the employment of another person, with a national minimum wage, generates a wage expenses saving of 60%, as it follows: for the payment of one employee, for a duration of 18 months, the employer has total expenses (net wage + contributions to pay) of about 22.150 lei; in turn, benefiting from subsidy, the expenses are reduced up to the level of 13.300 lei;
- the employer benefits from the deduction, from the amount of the subsidy to be received, of the contributions due by the entity to the unemployment fund;
- for each year in part (for maximum two years) of continuation of the work reports with the employed graduates, after the expiry of the term of 18 months, the employer will benefit from a social aid representing the amount of

social contributions due by him, for each graduate in part;

- according to the provisions of the same laws mentioned, can be organized instruction and professional training courses for the graduates employed, and the costs generated by these can be recovered, upon the employer's request, from the unemployment fund.

#### ***Management of human resources***

Young persons have skills and competences which place them on a favorable place in order to successfully fulfill the job requirements for which they are selected, thus the recruitment of personnel of this category will give a new employee to the entity, with the following features:

- enthusiasm;
- contribution of new, fresh ideas;
- capacity to accumulate a large number of information in short time;
- fresh knowledge in the technology field and rapid assimilation of some news in this field;
- program flexibility;
- relatively low wage claims.

#### ***Social***

- social responsibility, through the contribution to the unemployment reduction of young persons;
- accrual of self-confidence of the employed person.

#### ***Disadvantages:***

- the compulsoriness of keeping the work reports with the graduate employed for a period of 18 months;
- the lack of experience of young persons;
- preponderantly theoretical training of graduates, who haven't enough practical knowledge in the field studied, and this imposes increased time for the instruction;
- young persons have the tendency of instability to the work place, and the efforts with his training for the requirements of the job he occupies are lost if he chooses to leave the job in the favor of another employer.

#### **4. Accounting treatment of the subsidy collected for the employment of young graduates**

The subsidies are money or transfers of

non-monetary assets received from the Government, governmental agencies or other similar national or international institutions, having the following forms: governmental subsidies, non-refundable loans under the type of subsidies. From the point of view of their destination, the subsidies are divided in: subsidies related to the assets (investments subsidies) and subsidies related to the revenues (operational subsidies).

The subsidy granted in order to stimulate the employers who give a job to the graduates of educational institutions enters in the category of subsidies related to the revenues and, hereinafter, we propose ourselves to present the treatment of these amounts within the entity, from accounting and procedural point of view.

In order to obtain the subsidy, the employer shall submit a file to the territorial office of the County Employment Agency he belongs, including the specific documents provided in the related rules.

Accounting regulations in force point out that the subsidies won't be recognized "until there is no sufficient safety that the entity will observe the conditions imposed by their grant; and that the subsidies will be received" [4], fact which imposes their highlighting in accountancy only after the acceptance of the file by the County Employment Agency.

These will be recognized as it follows:

- from the point of view of the profit and loss account, as revenues of the corresponding period to the related expenses, which the subsidy will compensate;
- from the point of view of the balance, the receivable regarding the subsidy is recognized in correspondence with the related revenue accounts (if were made the expenses to be compensated through the subsidy) or at deferred revenue (if the respective expenses weren't made). Herewith, in proportion as the amounts are collected, the receivables accounts will be regularized.

In this way, starting with the next month of the registration to the County Employment Agency as beneficiary of the subsidy, in order to dispose of its collection, the employer shall monthly submit, according to the legislation in force, till the 25<sup>th</sup> day of the next month for which the wage rights are calculated, the statements regarding the payment obligations of the social contributions, the income tax and the

nominal evidence of the insured persons (D112) and, moreover, at the territorial employment office, the following documents related to the respective month: a copy of the time sheet and of the payroll and the nominal table of the employed graduates.

In accountancy, the operations described generate the following registrations:

*1. Registration of wages due to the employees:*

641	=	421
Salaries		Employees - salaries payable

*2. Registration of contributions retained for the employees:*

421	=	%
Employees - salaries payable		4312
		Employees' contribution to pension fund
		4314
		Employees' contribution to health insurance
		4372
		Employees' contribution to unemployment fund
		444
		Tax on salaries

*3. Registration of contributions for the employer:*

6451	=	4311
Company's contribution to social security		Company's contribution to social security
6451	=	4311
Company's contribution to social security		Company's contribution to social security/ analytically distinctly insurance for work accidents and professional diseases

6453	=	4313
Expenses regarding the employer's contribution for social health insurances		Company's contribution to health insurance

6453	=	4313
Company's contribution to health insurance		Company's contribution to health insurance/ analytically distinctly FNUASS

6452	=	4371
Company's contribution to unemployment fund		Company's contribution to unemployment fund

6452	=	4371
Company's contribution to unemployment fund		Company's contribution to unemployment fund/ analytically distinctly Guarantee Fund for the Payment of Wage Receivables

*4. Payment of net wages:*

421	=	5311
Employees - salaries payable		Petty cash in lei

*5. Registration of the subsidy to be received:*

4451	=	7414
Government subsidies		Subsidies for wages and salaries

*6. Deduction, from the value of the subsidy to be received, of the contributions due by the entity to the unemployment benefit:*

4371	=	4451
Company's contribution to		Government subsidies

unemployment fund

7. *Subsidy collection:*

5121	=	4451
Cash at bank in lei		Government subsidies

If the entity terminates, at its choice, the work reports with the graduate for whom is received/ was received the subsidy before the fulfillment of the 18 months of contract, it has the obligations to fully reimburse the amounts collected, together with the reference interest of the Romanian National Bank in force on the termination date of the contract. Such a situation generates the following registrations in accountancy:

1. *Cancellation of previous registrations regarding the subsidy (with the amount in red):*

4451	=	7414
Government subsidies		Subsidies for wages and salaries
	<i>and:</i>	
4371	=	4451
Company's contribution to unemployment fund		Government subsidies

2. *Reimbursement of the subsidy received and payment of related interest:*

%	=	5121
4551		Cash at bank in lei
Government subsidies		
6588		
Other operating expenses		

5. **Conclusions**

The attraction of young graduates within the recruitment, selection and employment process of the entity personnel, in order to have the access to the subsidies granted through the programs of active measures implemented by the Government, can represent a solution for ensuring the equilibrium between the keeping and the development of the human resource and the

costs associated to it, fact which contributes, among others, to the performing management of the human resources component of the entity.

In the practical activity, on the labor market, the lack of experience of young graduates represents a significant aspect of the employers decision to not recruit personnel from this category. In this respect, we consider that such a perception can be changed because, as it results from the research undertaken, there are many positive aspects which can be brought by the young graduates in the entity's benefit. An additional reason in this respect is represented by the fact that the procurement of subsidies of this type doesn't presuppose a complex procedure from the employer's part and the booking of such operations doesn't generate major difficulties.

6. **References**

- [1] Cornescu, V., Marinescu, P. D., Curteanu, Toma,S., "Management – de la teorie la practică-" (*Management – from theory to practice*), University Publishing House, Bucharest, 2004.
- [2] Bădescu, A., Mirci, C., Bogre, G., "Managementul resurselor umane : manualul profesionistului" (*Management of human resources: professional's manual*), Brumar Publishing House, Timișoara, 2008.
- [3] Sectoral Operational Program Human Resources Development 2007-2013.
- [4] Order of the Ministry of Public Finance no. 1802 for the approval of Accounting Regulations regarding the annual individual financial statements and the annual consolidated financial statements, Official Gazette no. 963/30.12.2014.
- [5] România în cifre (Romania in figures), 2015.
- [6] Practical guide for the implementation of Accounting Regulations regarding the annual individual financial statements and the annual consolidated financial statements, CECCAR Publishing House, Bucharest, 2015.

## Accounting and Tax Challenges Regarding the Joint Ventures

Cristian Drăgan

*University of Craiova, Faculty of Economics and Business Administration*  
[cdragano11@gmail.com](mailto:cdragano11@gmail.com)

Magdalena Mihai

*University of Craiova, Faculty of Economics and Business Administration*  
[magda@auditsiexpertiza.ro](mailto:magda@auditsiexpertiza.ro)

Carmen Maria Dindiri

*University of Craiova, Faculty of Economics and Business Administration*  
[mari.negrila@yahoo.com](mailto:mari.negrila@yahoo.com)

### Abstract

*Joint ventures represent, in many cases, a more efficient way of use of available resources from the patrimony of individual and legal persons. The so-called realization of joint venture supposes, besides the legal aspect of conclusion of a contract between the parties involved, which delineates in this respect the coordinates of the joint ventures and the adequate accounting and tax settlement of specific operations.*

*From this perspective, the study aims to succinctly present the problematics of this type, illustrating the main legal, accounting and tax aspects.*

**Key words:** joint venture, legal aspects, accounting mirror, tax implications.

**J.E.L. classification:** M 41.

### 1. Introduction

The association between individual or legal persons in order to realize an objective which meets their mutual interests represented a method frequently practiced and, herewith, an instrument with beneficial effects in business development, generally.

The development of transactions by means of the association also represents a frequent practice within the national economy and a special place conferred by the frequency with which it appears is occupied by the joint venture.

Nowadays, the legal regulatory framework is represented by the Civil Code [1], which, at the art. 1949 defines the joint

venture agreement as being “the agreement through which a person gives to another or to more persons a participation to the benefits and the losses of one or more operations undertaken”. Such an agreement of the parties is proved only through a deed and the resulting association cannot acquire legal personality and it doesn't represent, before third parties, a person different from the partners.

From the legal point of view, it is also noticed the fact that the business partners remain the owners of the goods put at the association's disposal and, herewith, there is the possibility that they agree that the goods brought in the association and also those resulting from their use become a mutual property.

In respect to the association's form and conditions, we mention that the parties involved are those who establish the type of the agreement, the duration and the specific conditions, including the dissolution and liquidation clauses, an exception being only certain elements expressly provided by the law mentioned.

Obviously, such a legal provisions has also accounting implications, being imposed the application of the accounting professional reasoning and the clear delimitation of the economic fund of all matters resulting from the legal aspects written in the agreement concluded between the parties.

This fact imposes the treatment of each joint venture with professional rigor which, in our opinion, represents a permanent challenge, mainly for the entity which organizes and manages the association's bookkeeping.

In another train of thoughts, we also mention the fact that under the aspect of the terminology used in the practical activity it is possible the apparition of some confusions between the joint venture and the public-private partnership. However, the specialty literature rigorously delimits the two concepts, illustrating, for the most part, the differentiation elements which characterize it, among which we mention those considered relevant in the context of the paper, namely [2]:

- the public-private partnership in contrast with the joint venture gives birth to a legal entity organized and which operates according to the Law no. 31/1990 regarding the trading companies;

- in case of joint venture, is allowed the development of any type of activities, while in case of the public-private partnership the range of activities which can represent its object is limited through legal express provisions [3];

- the financing of common activities is realized by both parties, in case of joint venture, in contrast with the public-private partnership, where the financing is realized only by the private partner.

Considering the aspects previously exposed, to which we add the fact that, in time, in the specialty literature existed debates and doctrinaire controversies regarding this subject, we think that there are enough arguments justifying the approach undertaken within this study to succinctly expose, together with the legal characteristic elements, of main accounting and tax aspects which overlap in the situation of the agreements of this type.

## **2. Significant accounting aspects regarding the joint ventures**

The accounting aspects regarding the joint ventures are presented in the content of some distinct sections from the Accounting Regulations regarding the annual individual financial statements and the annual consolidated financial statements [4].

Thus, it is needed to appoint the business partner who organizes and manages the association's bookkeeping within the agreement concluded between the parties. He has the obligation to reflect, distinctly from the other operations realized, all the specific

activities of the joint venture, until the level of the trial balance [5].

The delimitation of specific operations of the association from the other activities realized by the entity represents, in our opinion, an aspect which, at least from the IT point of view, can generate errors. In this respect, we consider the fact that it is necessary to open analytical accounts which ensure the separation of the operations realized and, herewith, to allow the elaboration of the discount regarding the revenues and the expenses transmitted to the business partners. As a possible elimination of such a failure, we consider that the association can be considered a distinct entity within the soft through which is realized the bookkeeping of the specific operations, thus avoiding the definition of several analytical accounts with the risks mentioned.

Moreover, the rigorous separation of the association's activities imposes the use of the account 458 "Transactions related to joint ventures", both to the entity appointed to organize and to manage the accounting evidence of the association and to the co-participants.

This follows all elements put in common according to the agreement signed between the parties, including the transmission of the revenues and the expenses of the association to co-participants, delimited on types or categories depending on the provided profit ownership, according to a discount elaborated in this respect at the end of the reporting period by the business partner charged with the accounting evidence.

If intangible and tangible assets are put at the association's disposal, these shall be also found in the owner's accounting evidence. Herewith, we mention the fact that the reserves, the receivables, the liquidness, including the debts resulting from the joint venture are presented in the annual financial statements presented by the business partner charged with the management of the accounting evidence.

The booking of operations of this type inevitably supposes associated tax implications whose presentation is realized in the content of the next section of the study.

The so-called accounting reflecting of joint ventures can be systematized in the manner presented below, separately for the

entity which has responsibilities in this regard for the co-participants too.

A. The entity which organizes and manages the accountancy.

- Registration of contributions provided in the joint venture agreement.

**Accounts** = **458** Amount  
**according to** *Transactions*  
**the type of** *related to joint*  
**the** *operations/*  
**contribution** *subsidiary*  
(Fixed assets, *account for*  
stocks, cash at *each co-*  
bank and on *participant*  
hand s.o.)

- Collection of expenses realized in association:

**6xx** = **Accounts** Amount  
**which indicate**  
**decreases of**  
**the economic**  
**benefits**

- Finding of the revenues realized in association:

**Accounts** = **7xx** Amount  
**which**  
**indicate**  
**increases of**  
**economic**  
**benefits**

- Distribution of revenues to co-participants, according to the discount elaborated in this respect and to the shares determined in the contract:

**7xx** = **458** Amount  
*Transactions*  
*related to joint*  
*operations /*  
*subsidiary*  
*account for*  
*each co-*  
*participant*

- Distribution of expenses to co-participants, according to the discount elaborated in this respect and to the shares determined in the contract:

**458** = **6xx** Amount  
*Transactions*  
*related to joint*  
*operations/*  
*subsidiary*  
*account for*  
*each co-*  
*participant*

- Transfer of the amounts due from joint ventures to co-participants:

**458** = **5xx** Amount  
*Transactions*  
*related to joint*  
*operations/*  
*subsidiary*  
*account for*  
*each co-*  
*participant*

B. Co-associated entity.

- Registration of contributions put at the association's disposal.

**458** = **Accounts** Amount  
*Transactions* **according to**  
*related to* **the type of**  
*joint* **the**  
*operations/* **contribution**  
*subsidiary* (Fixed assets,  
*account* stocks, cash at  
*partner* bank and on  
*charged with* hand s.o.)  
*the*  
*accounting*  
*evidence*

- Registration of assumption of expenses distributed from the joint venture.

**6xx** = **458** Amount  
*Transactions*  
*related to*  
*joint*  
*operations/*  
*subsidiary*  
*account*  
*partner*  
*charged with*  
*the*  
*accounting*  
*evidence*

- Registration of assumption of expenses distributed from the joint venture.

**458** = **7xx** Amount  
*Transactions*  
*related to joint*  
*operations/*  
*subsidiary*  
*account partner*  
*charged with*  
*the accounting*  
*evidence*

- Accounting reflecting of the amount due from the joint venture.

**5xx** = **458** Amount

*Transactions  
related to  
joint  
operations/  
subsidiary  
account  
partner  
charged with  
the  
accounting  
evidence*

Obviously, the accounting registrations presented at the point B are realized by the shareholders - legal persons. In case of shareholders - individual persons is imposed only the declaration of the profits distributed from the joint venture, as it is presented in the next section of the study.

### **3. Tax implications regarding the joint ventures**

The operations undertaken for the realization of joint ventures also present a series of tax aspects, which are determined both by the general provisions in matters, which aim this type of operations, and by the specific elements found within the agreements of this type.

With this in view, in the context of the material elaborated, we consider relevant the operations regarding the value added tax and the profit/ income tax which are succinctly presented below.

In respect to the **value added tax**, according to the tax regulations in the field [6], the right to practice the deduction of the tax for acquisitions and also the obligation to issue invoices and to collect the tax fall on the entity appointed by the parties to organize and to manage the accounting evidence of the joint venture.

Herewith, the goods or the services which are put at the joint venture's disposal by the co-participants in the form of the contribution don't enter under the VAT incidence and the business partners keep the right of deduction. A special mention is needed in case of capital goods regarding the period while these were put at the joint venture's disposal, period in which the co-partners don't perform adjustments of the related tax.

If there are any other goods or services which the co-partners put at the joint

venture's disposal, others than those previously mentioned, these are considered deliveries and enter under the incidence of the value added tax.

The shareholder who managed the accounting evidence makes acquisitions for the joint venture and he issues invoices in his name for the deliveries of goods and for the supply of services performed by the third parties within the operations realized in the joint venture and, subsequently, he transmits the resulting expenses and revenues to each co-associate, according to the participation quote in the joint venture.

In its turn, **the profit/income tax** presents particularities in the context of the operations related to the joint venture, whose illustration we think it can be realized, more suggestively, through the delimitation of the types of association which can be realized between different individual and legal persons.

Thus, if *the joint venture is realized between Romanian legal persons*, the revenues and the expenses obtained under these conditions are totaled, after their transmission according to the discount elaborated by the entity which organizes and manages the accountancy, with the revenues and the expenses obtained from the own activity by each shareholder, and the taxable profit determined is submitted to the quote of 16% at the level of each entity in part.

If *the joint venture agreement is concluded between a legal person and an individual person*, both from Romania, the legal person is appointed with the organization and the management of the accountancy and, herewith, he determines the profit tax, usually, through the application of the quote of 16% at the profit obtained from the own activity to which it is added that distributed from the joint venture activity. If the entity has losses from its own activity, it is compensated with the profit obtained from the joint venture, aspect found, as a matter of fact, in case of joint ventures between legal persons.

For the revenues fallen on the individual person, the entity withholds the tax under the form of the advance payments, and the calculation is realized through the application of the quote of 10% to the gross profit obtained by the individual person. The tax withheld in this situation is paid by the entity



until the 25<sup>th</sup> day, including of the following day to that in which it was paid.

If the legal person comes in the category of micro-enterprises, the tax calculated and withheld by the entity is determined through the application of the quote of 3% on the revenues deserved by the individual person.

*The profit due to the individual person* from such a joint venture, determined by the legal person according to the rules regarding the profit tax, *is considered revenue from independent activities* and it is included within the income tax, and the tax calculated, withheld and paid by the legal person in the account of the individual person for the revenues from the joint venture is considered payment in advance in the account of the annual income tax. Herewith, it is mentioned that the profit due to the individual person comes in the category of the gross income from independent activities and from this will be deducted the mandatory contributions in order to determine the net revenue of this type. This aspect can lead, in our opinion, to tax risks under the conditions in which the individual person, frequently unacquainted with the specific actions for the declaration of the revenues, doesn't perform the approach needed in these circumstances.

#### 4. Conclusions

The joint ventures represents specific materialization methods of cooperation between various categories of individual and legal persons, who are frequently called in the practical activity, having a complex regulatory framework under the legal, accounting and tax aspect.

Although it doesn't present own legal personality, it needs a careful approach in respect to the rigorous delimitation of the operations carried out in the joint venture from the other operations realized by the parties involved, because in this context it is approached the entire accounting and tax problematics associated to it. Among others, it supposes, where it is possible, the identification of the best solution in respect to the determination of the shareholder charged with the organization and the management of the joint venture's accountancy.

Since the features of each joint venture in part are directly influenced by the provisions

registered in the agreement signed between the parties or, in other words, by the specific legal shadings, it is needed the frequent use of the professional accounting reasoning which ensures the analysis of the economic fund of all operations of this type undertaken by the shareholders and, as a consequence, the accounting reflecting corresponding to it.

#### 5. References

- [1] Law no. 287/2009 regarding the Civil Code, published in the Official Gazette of Romania, Part I, no. 409 from 10<sup>th</sup> of June 2011.
- [2] C. Marinescu, *Asocierea în participațiune versus parteneriatul public-privat (Joint venture versus public-private partnership)*, RFPC no. 2/2011, page 62-63.
- [3] Law no. 178 from 1<sup>st</sup> of October 2010 of the public-private partnership, Official Gazette no. 676/05.10.2010.
- [4] Order of the Ministry of Public Finance no. 1802 for the approval of Accounting Regulations regarding the annual individual financial statements and the annual consolidated financial statements, Official Gazette no. 963/30.12.2014.
- [5] Practical guide for the implementation of Accounting Regulations regarding the annual individual financial statements and the annual consolidated financial statements, CECCAR Publishing House, Bucharest, 2015.
- [6] Law no. 571/2003 regarding the Tax Code, with subsequent amendments and additions, Official Gazette no. 927/22.12.2003.

## The Aspects of Revaluation of Tangible Assets

Andreea Elena Dreghiciu

„1 December 1918” University, Alba Iulia, Romania

[deea\\_dreghi@yahoo.com](mailto:deea_dreghi@yahoo.com)

### Abstract

*To be registered in the current accounting and to be recognized by the annual financial statements, an entity asset must be evaluated. Without using the evaluation, and also the revaluation, the accounting couldn't present in a correct way the financial position of an entity and its performance, and it could not calculate the economic and financial indicators on the microeconomic and macroeconomic level. The revaluation of tangible asset has an accounting effect, leading to the modification of the values which were initially recorded in accounting. The highlight of revaluation reserves must be done on each corporal tangible asset and on each revaluation operation that has been done.*

**Key words:** *tangible assets, revaluation, amortization, depreciation, revaluation reserves.*

**J.E.L. Classification:** M40, M41

### 1. Introduction

The realities of modern society shows us that along with the marketing's economical development and its increasing complexity degree, it must properly develop, like area, content, promptness and economic information, so it can supply the necessary elements in making a decision, to reflect the patrimonial situation of the entities and the results of economical and financial activities. [1]

To present the actual information, the entities, no matter what their legal status of organization is - autonomic administration or commercial societies - they feel in the course of their activity the need to measure the

possibilities, their strengths and/or weaknesses. This need comes from various reasons such as: performances or strategies improvement, carry on a possession transfer under the form of partial or total transactions, in the way of some attending, fusions or sales.

Usually the economic evaluation, and in the same time the revaluation, have the final purpose to determine the market value of a property, an asset, a society, and in this way it provides the current information about the property or asset we talked about.

Regarding the revaluation, this means to evaluate again and update a preexisting value. [2]

The revaluation of tangible assets represents a topic that has been always manifesting interest, especially considering the implications of this operation on the values recorded in the accounts. Attention must therefore be paid to how the revaluation reflects in the financial situations.

Conceived and structured on a complex problem, the paper focuses on the presentation of some accounting elements concerning revaluation of tangible assets, and a case study that reflects the revaluation implications made upon the accounting registrations of tangible assets.

### 2. Methodology

Any scientific research should have a purpose. The purpose of this research is to present theoretic aspects related to the importance of revaluation of tangible assets.

The methodology that we use is based on theoretical research regarding the concepts and regulation from the area, accompanied by empirical research. To do this paper we appeal to the studies of International Standards of

Evaluation, works from the accounting fields made by consecrate authors, the analysis of the regulatory field, being a qualitative exploratory research, and practical issues regarding revaluation of tangible assets that can appear within an entity. So this is a descriptive quantitative research.

### 3. General aspects regarding tangible assets

The conduct of an entity activity requires a technical and material basis in which the fixed assets have an important economical role and hold a significant weight.

To define a fixed asset it should be considered the description of an asset made according to IAS, and also the purpose for which it is used. An asset represents a resource controlled by entity as a result of some passed events from which it's expected to generate future economical benefits for the entity. The purpose of using it is the sustainable use, usually for more than one year.

The fixed assets are asset elements, held for more than a year, which generates future economic benefits for the entity. [3]

Tangible assets are those tangible items held to be used in the productions of goods or services, for rental to third parties, or for administrative purpose, and which are expected to be used during several periods.[4]

Regarding recognition as tangible assets, the phenomena occurs when the generation of future economic benefits it's possible and then they may be attached with a credible value.

Due to the fact that the tangible assets are used in a sustainable way, except lands, losing their value because of physical or moral damage, as well as various economical, social or political agents, requiring to adjust their value, in order to be recognize as close to reality in annual financial situations. This adjustment of fixed assets must be seen in two ways:

-permanent adjustment, definitive, irreversible, also known as amortization;

-reversible adjustment, temporary, also known as depreciation adjustment.[3]

Amortization is the gradual recovery process of the amortization value of an asset. The recovery it is usually done during the

useful life, by including a part of the amortized value in the exercises' expenses, under the reduction in value.

Annual amortization of the immobilized capital in various affects, involves very different interest of entrepreneurs, stockholder and the state. [5]

The entrepreneur has the interest to recover as fast as he can the capital invested in assets because he wants to be able to reinvest it.

Stockholders have a contrary interest, because they seek to obtain bigger dividends or annual amortization because increasing cost will reduce profit, with other words will decrease the calculation base for dividends.

In a short term, the state has the interests that companies get bigger profits to benefits the bigger revenue under the income tax. In a long term, the state has the interest that the enterprises get strengthen and to increase their economical power.

At the balance sheet date the book value is determined by evaluation rules subsequence to initial recognition. This is the case of tangible and intangible assets for which the input book value can be changed during asset's life time.

There are two treatments that can be adopted for subsequent measurement of immobilizations:

a) a treatment which provides that: after the initial recognition as an asset, an immobilization must be recorded at cost, less any related accumulated amortization and any accumulated impairment losses;

b) a treatment which provides that: after the initial recognition as an asset, a tangible asset or an intangible asset must be recorded at the revalued value which represent the fair value at the revaluation time, less any subsequent accumulated amortization and subsequent accumulated impairment losses.[6]

The adjustments for devaluation and loss of value represent the difference between the cost or recorded value of the assets and their net recoverable amount. [1]

The precautionary principle mentions that we must take in consideration all devaluation, whether the result of the financial exercise is a loss or a profit. The recording of devaluation or loss of the values adjustments are made on the

expense accounts, no matter what the impact of the profit and loss account is.

To determine if there are devaluations of tangible and intangible assets, beside the time when inventory may be observed, we can take in consideration external and internal sources of information. [7]

#### **4. Accounting issues regarding revaluation**

The assets revaluation is an economical operation after which the book value of assets is correlated with their current value, providing the registration of relevant dates in annual financial statements, the clear calculation of economical and financial indicators, and by these an information as accurate as possible of the accounting information of the users. For this reason, a particular importance is the correct assessment of revalued value. [3]

The rules of revaluation are referring at:

a) On the balance sheet date, revaluation of tangible assets is made at fair value. The fair value is determined on the basis of assessments undertaken usually by professionals which are authorized according the law. [8]

b) Revaluations should be made with sufficient regularity so the carrying amount not differ significantly from that which would be determined using fair value on the balance sheet date. The frequency of revaluations depends on the evolution of the fair value of tangible assets in question. If the fair value of a revalued asset differs significantly from the carrying value, then a further revaluation is necessary. Some tangible assets can experience significant and volatile changes in fair value, and for that they require annual revaluation. For those tangible assets that fair values are not suffering, it is not necessary to make revaluations. For these, the revaluation which is done at 3-5 years can be more suitable.[4]

The assets which belong to the same class of property must be revalued simultaneously whit the purpose to avoid selective revaluation and the report of the amounts which are a combination of values at different dates in the annual financial situations.

If an asset which belongs to a group of assets may not be revalued, for example,

because there isn't an active market for the asset, the asset must be shown in the balance sheet at cost, less the adjustments of the accumulated value.

If the fair value of a tangible asset cannot be determined, the asset value shown in the balance sheet should be its revalued amount at the date of the last revaluation, from which we take the adjustments of cumulated value. [9]

In the case that a carrying amount of an asset is increased as a result of a revaluation, this increasing must be registered in the equity credit accounts under the title of "diferences from revaluation". However, the increasing established from revaluation should be recognized as income in the way that reverses a revaluation decrease of the same asset, previously recognized as an expense. Plus the amount resulting from comparing the fair value with the net book value is treated as an increase of revaluation reserve.

If the book value of an asset is reduced as a result of a revaluation, this decrease shall be recognized as an expense which must be deducted directly from the corresponding revaluation surplus for that same asset, whit the condition that the decrease does not exceed the value previously recorded as revaluation surplus. If revaluation represents a decrease of the net book value, then it is treated as a reduction of the revaluation reserve.

The revaluation surplus which was included in personal capital can be directly transferred in the reported result when the surplus is realized. It's considered that the entire surplus is realized on the disposal or retirement of the asset. However, a part of the surplus may be realized as the asset is used by enterprise; in this case, the value of the surplus realized is the difference between amortization based on the revaluation of the book value and amortization based on the asset's original cost. The transfer from revaluation surplus into reported result is not made through profit or loss account. The revaluation surplus is capitalized by direct transfer to reserves, as deregistration of the asset for which the revaluation reserve was formed or as the asset is used by an entity. [1]

In the last case, the value of the transferred reserve is equal with the difference between amortization based on revaluation of the book

value and the amortization based on asset's original cost.

At the moment of the revaluation of a tangible asset accumulated to date of the revaluation the revaluation is treated in one of the following ways:

a) proportionately recalculated with the change of the gross book value of asset, so that the book value of asset, after revaluation, to be equal with its revaluated value. This method is often used if the asset is revaluated by the application of an index; (Gross method)

b) removed from the gross book value of asset and net value and determined after the correction of value adjustments, it is recalculated at the revaluated value of asset. (Net method) [8]

The adjustments of the value shall be calculated in each financial exercise based on the reevaluated values of those assets. If the revaluation is done, then it must be separately presented in the explanatory notes, for each item from the revaluation of tangible asset balance, the following information: the fair value of the historical cost of revaluated assets and the amount of cumulative adjustments value, or the value on the balance sheet date of the difference between the unrealized accounting and its historical cost and, when is necessarily, the cumulative value of the additional adjustments.[8]

### 5. A case study regarding the methods of recording revaluation results and their implications.

For doing the annual financial situation in the S.C. EXEMPLU S.A., it was conducted to the revaluation of property. After the revaluation was done it was found added value, but also minuses.

The entity owns a plant acquired at the cost of 254,800 lei, linearly amortized in 10 years. At the final of the second year, the plant is revalued; the fair value is determined by an appraiser authorized by 214,032 lei. It also owns a cold store recorded to an input value of 120,000 lei, linearly amortized in 10 years. The deposit is revalued to fair value after 2 years from 88300 lei.

1<sup>st</sup> case: Applying the gross method for the registration of the plant revaluation result.

The cost = 254800

Annual amortization = 254800/10 = 25480

Annual accumulated amortization = 25480\*2 = 50960

Net book value = 254800 - 50960 = 203840

The fair value = 214032

The actualization index = 214032/203840 = 1,05

Gross book value = 254800 \* 1,05 = 267540

Updated gross book value – initial gross value book = 267540 – 254800 = 12740 (positive difference from revaluation of the gross)

Updated accumulated amortization = 50960 \* 1,05 = 53508

Updated accumulated amortization – initial accumulated amortization = 53508 – 50960 = 2548 (the positive difference from the previous revaluation of the accumulated amortization)

The registration of the revaluation operation in accounting:

2131	=	%	12740
„Equipments”		2813	2548
		„Equipments amortizations”	
		105	10192
		„Revaluation reserves”	

By the end of the year, the plant will be recorded in the accounting with value of 214 032.

2<sup>nd</sup> case: Applying the net method for the registration of the revaluation plant result.

The cost = 254800

Annual amortization = 254800/10 = 25480

Annual accumulated amortization = 25480\*2 = 50960

Net book value = 254800 - 50960 = 203840

The fair value = 214032

The fair value - Net book value = 10192 (the positive difference from revaluation)

The elimination of accumulated amortization of the gross

2813	=	2131	50960
„Equipments amortizations”		„Equipments”	

The registration of the positive value from reevaluation

	2131	=	105	10192	
„Equipments”			„Revaluation reserves		

No matter what the method of accounting is, the balance of 105 account “Revaluation reserves “ is the same 10192.

3rd case: The registration of the revaluation difference is a decreasing of the cold store value. The revaluation reserve will be accounted by net method. To highlight the impact of value decreasing, we will focus on tax amortization.

The cost = 120000

Annual amortization =  $120000/10 = 12000$

The annual accumulated amortization =  $12000*2 = 24000$

The net book value =  $120000 - 24000 = 96000$

The fair value = 88300

The fair value – Net book value =  $88300 - 96000 = -7700$  (the negative difference from revaluation)

The elimination of accumulated amortization of the gross

	2812	=	212	24000	
„Buildings amortization”			„Buildings”		

The registration of the negative value from reevaluation

	6813	=	212	7700	
„Operating expenses regarding adjustments of the impairment on property”			„Buildings”		

The annual accounting amortization before revaluating =  $120000: 10 = 12000$

The annual accounting amortization after revaluating = 88300: 8 = 11037,5

Since the fair value established by the revaluation of the cold store (88300) is less than the net book value (96000) the depreciated tax values it will be 96000. In this case, the annual tax depreciation, after revaluating is: the

net book value: the remaining service life =  $96000 : 8 = 12000$ .

The tax depreciation will not be recorded in the accounts, but will be used to determine income tax. In this purpose, accounting amortization amounted to 11037.5 will be considered tax deductible expense. But the tax depreciation in amount of 12,000 represents tax deduction.

## 6. Conclusions

The revaluation it’s made according to certain laws that permit it and the final decision is taken by the trader. After revaluations, the increases or decreases in value results, to be considered and recorded as revaluation reserves, must go through one condition, the sustainability (depreciation and / or repreciation to be sustainable).

The revaluation has tax influences because is due taxes for intangible nature of buildings and construction.

Entities must perform revaluation of tangible assets with sufficient regularity, if not it will appear great differences. It must take in consideration the tax impact when the recording method of accounting results will be chosen.

## 7. References

- [1] Pântea I. P., Bodea Gh., *Contabilitatea financiară*, Ed. INTELCREDO, Deva, 2013.
- [2] Todea N., *Evaluarea proprietății imobiliare și a întreprinderii*, Ed. Aeternitas, Alba Iulia, 2004.
- [3] Mătiș D., Pop A., *Contabilitate financiară*, Ed. Casa Cărții de Știință, Cluj Napoca, 2010.
- [4] Standardele Internaționale de Raportare Financiară, 2015, IAS 16 Imobilizări corporale.
- [5] Banc P., *Gestiune financiară*, Seria Didactică, Alba Iulia, 2010.
- [6] Ristea M., coordonator, *Contabilitate financiară*, Ed. Universitară, București, 2005.
- [7] Ristea M., Dumitru G. C., Manea L., Nichiță M., Deprecierea imobilizărilor corporale: aspecte desprinse din reglementările contabile armonizate cu directivele europene publicate în OMFP nr. 3055/2009 față în față cu cele din IAS 36 Deprecierea activelor, *Revista Corpului Experților Contabili și contabililor Autorizați din România*, nr.1, ianuarie, 2011, pag. 30.

[8] Ordin nr. 1802/2014 din 29/10/2009 pentru aprobarea Reglementărilor contabile privind situațiile financiare anuale individuale și situațiile financiare anuale consolidate. Publicat în MOF nr. 963/30.XII.2014.

[9][http://discutii.mfinante.ro/static/10/Mfp/reglementaricontabile/Ghid\\_27092010.pdf](http://discutii.mfinante.ro/static/10/Mfp/reglementaricontabile/Ghid_27092010.pdf), 10.01.2015

## **8. Thanks**

„This paper/article received financial support through the European Quality PhD - EURODOC “Contract no. HRD / 187 / 1.5 / S / 155,450, financed from the European Social Fund Operational Program Human Resources Development 2007-2013.”

## Financing Policies in the Romanian SMEs

Lucian Găban

1 Decembrie 1918 University, Alba Iulia, Romania

[gabanvasilelucian@gmail.com](mailto:gabanvasilelucian@gmail.com)

### Abstract

*In this paper the author shows the modalities for financing the operating activity, on the one hand taking into account the sources flows and, on the other hand, the usage flows.*

**Keywords:** funds flows, cash flows, source flows, usage flows.

**JEL Classification:** G32.

### 1. Introduction

Financial policies trigger the company's financial strategies and they are part of the general strategy of the company. Nevertheless, financial policies are applied through decisions grouped into three categories: operational decisions, investment decisions and financing decisions. The implementation of these decisions and their consequences may track the flow of funds, which is revealed by the cash flow. In this paper, I describe the usage of the working capital regarding the financing of the operating activity based on the financial decision.

The paper has three parts: literature review, the financing modalities of the enterprises and conclusions.

### 2. Literature Review

Financing the business is an important issue for any investor. During the latest period, the financial crisis resulted in a reduction of funding resources. Therefore, the main source for businesses in Romania is to finance their activities based on the working capital.

The topic of the working capital has been addressed in numerous papers, some of which are mentioned below. Various authors remark that every business begins with a sum

of money. The acquisition of goods and services together with the production process changes available funds into inventories. In turn, every sales operation changes inventories into receivables that become cash once clients pay. If this system functions properly, the process repeats endlessly [1].

Other authors mention that, in accordance with IFRS, the cash cycle is based on financial policies and it is structured into three parts: operating activity, investing activity and financing activity [2].

Various studies regarding international practices of investment appraisal performed on US-based multinationals suggest that many companies do not conform to theoretical ideas on project screening and on the ideas used for domestic projects [3].

Other studies aim to present the link between financial decisions, innovation, company profit and company value [4].

Financial decisions impact on performance. Hence, there are various limits in employing traditional statistic methods in order to study financial performance. The grey system theory compensates these limits and proves to be more suitable in assessing business financial performance [5].

A recent study investigated the manner in which corporate financial decision-makers regarded fundamental workplace safety aspects as a function of the company size [6].

Another paper specifies the long term trend of working capital in Turkey. The study implies that there are working capital policies as well as optimal working capital levels [7].

By examining US corporations during the period 1990-2006, it was found that, in the case of an average company, the incremental dollar placed in net operating working capital counted less than the incremental cash dollar [8].

The link between the working capital and the cash conversion cycle of SMEs has been analyzed in other papers. It has been reported that such entities aim a certain length of the



cash conversion cycle, they strive to maintain it adjust their profit sales to this target [9].

Managing the current assets and liabilities of a company determined the success of that company. Although the impact of short-term liquidity on the working capital management are obvious, its impact on company profitability remains an open empirical question [10]-[11]-[12].

Working capital is the lifeblood of any business. In practice, a company must use short-term assets and financing resources besides fixed assets (i.e., *working capital management*). This particular strategy focuses on maintaining efficient levels of both working capital components [13].

Managers need to grasp the specifics of the business cash cycle generated by daily investing, operating and financing decisions, and also the various external factors impacting on the business [14].

The specialty literature denominates financing sources funds flows [15].

Other researchers report that the working capital is a form of liquidity highlighting the resources available after covering short-term liabilities [16]. For this reason, the analysis of the working capital ratio is an important target for every manager of Romanian companies [17].

The balance sheet shows the changes which took place in different items, during an analyzed period [18]. Each change implies that an amount of money entered or exited the company and that cash has been generated or consumed [19].

Table 1 provides a general image on the impact of the changes in the capital of the company.

Table 1. The changes in the financial position of the enterprise

Elements	Changes	
	Increases	Decreases
Assets	Expenses	Financing source
Debts and Equity	Financing source	Expenses

Source: Own representation.

The type of the change and the position where the change is recorded in the balance sheet may mean consumption or financing source.

For the analysis of the financial statement of a company it is important to determine the source and the purpose of the additional sums obtained from one year to another. Furthermore, a statement of capital circulation called funds flow statement is drawn up. Table 2 indicates the content of such statement.

Table 2. Funds flow into the company

Indicators
Capital sources
Net profit
Cash decrease
Receivables decrease
Amortization
Supplier debts increase and assimilates
Increase in short-term credits
Increase in different taxes

Capital uses
Stock increases
Basic investments
Other investments
Dividend payment

Source: Own representation

The information included in the above table implies that:

- Sources for financing expenses on the short-term are quite numerous. Clients or other organizations, from which the company borrowed, can take up loans without interest. The net profit of the company may contribute to its financing.

- Part of the funds is available for a short period of time, since there is a significant discrepancy between the quantity of available funds and the necessary ones.

- Amortization is an important funding source.

- Funds obtained are intensively used in the analyzed company. Some are used for investments in plant and equipment, others for investments in warehouses and other for financing inventory.

Among the capital sources mentioned above, several result coming from operations performed by the company. These are called *funds provided by operation* (FPO) and included several elements, as presented in table 3.

Table 3. The structure of funds provided by operation (FPO)

No.	Indicators
1.	Net profit
2.	Amortization
3.	Increase in owed taxes
	<b>Funds provided by operation</b>

Source: Own representation.

FPO is the indicator showing the capacity of the company to generate itself the required funds.

The capital sources identified above can be used for investments only if they have not been used for the current purposes of the company, such as increase in inventory expenses. If this increase is subtracted from the funds flow, the cash flow from operations results.

**Cash Flow = Funds Flow – Increase of Inventory Expenses**

The cash flow is calculated by adding the following elements: net income; depreciation; increase/decrease in the deferred taxes; accounts receivable; account payable; accrued expenses; notes payables; cash; inventory.

If the respective positions generate cash, the sums add. If they consume cash, the corresponding amounts decrease.

The cash flow serves to the evaluation of the company's capacity of financing investments with own means.

The concept of working capital emerged after acknowledging the fact that, from the amount of used capital, only the one recorded in the balance sheet as current assets suffers daily changes, according to the activity of the company. Long-term assets remain uninfluenced by these short-term changes. A part of the current assets results from the financing made through current liabilities. The enterprise can invest only the difference in the current assets. This difference is in fact the working capital and represents the investments made by the company in current assets, respectively in cash, account receivable and inventory.

**Working Capital = Current Assets – Current Liabilities**

The working capital for the analyzed case is presented in table 4.

Table 4. The structure of the working capital

Elements	Year 1	Year 2
Current assets	5,000,000	6,000,000
Current liabilities	4,000,000	5,500,000
Working capital	1,000,000	500,000

Source: Own calculus.

The working capital is especially important for small businesses. These have the possibility of reducing their investments in long-term assets by renting buildings and leasing the equipment they need. The investments in working capital cannot be avoided. In order to satisfy business requirements, small businesses have to plan and ensure the funds required for financing current assets.

In the analysis performed until now, I presented the changes made in the income statement and balance sheet by the regular unfolding of the activity. An enterprise buys materials, employs personnel and sells merchandise. All these activities lead to permanent changes in the amount of money existing in the cash fund, to increases or decreases of the inventory, liabilities and credits.

The additional capital is used to finance the activity of the company, not for investments. This is the working capital. The businessman has to invest in current assets (not only in building and machinery).

The need for working capital varies cyclically: at the beginning, it is minimal; later, it increases significantly.

In a company, there is a permanent cash conversion cycle. The company needs a planning of the cash flow in order to be able to meet expenses (i.e., cash flow management). Cash flow management is based on the planning of income and expenses, so that the latter are made in due time and imply minimum financing costs.

**2. The analysis of the financing modalities of the company**

The inconsequence of the financial schemes refers to the lack of correlation with

the account plan and to the lack of correlation between funds flows and cash flows.

The funds schemes highlight the changes in the financial statement of the company during the financial period, from the moment receivables or obligations are generated by the company. Cash flow determined especially through the direct method refers to the operations concerning the cashing and payments made by the company during the financial period. Any other operation that does not involve the company in such actions is not taken into account. This is the reason for which the results obtained after determining the treasury and funds flows schemes are different.

Therefore, a financing scheme should base on cash flows and should highlight the types of policies that managers applied during the analyzed period.

Based on the data included in the balance of the company, I have regrouped the cash flows structured as follows:

- investment policy;
- dividend distribution policy;
- operation policy;
- treasury policy.

Each type of policy highlights resources and the usage of resource. Consequently, two situations result:

► *resource requirement*, if the usage exceeds the financial resources of the financial policy;

► *resource production*, if the resources exceed the resources usage.

Within the investment policy, the financial resources refer to:

- depreciation;
- subvention for investments;
- medium and long-term bank accounts.

The investment policy materializes into fixed assets (e.g., land, equipment).

**The financing policy** of operation or the policy of the working capital is based on resources like:

- 1) commercial credit from various suppliers and creditor-clients;
- 2) obligations towards employees;
- 3) fiscal and social obligations;
- 4) short-term bank credits.

The usage of such resources are mirrored by inventories and receivables.

The dividend policy refers to the obligation of the company to pay to its

shareholders the corresponding dividends, according to the decision of the shareholders' general assembly.

The policy regarding equity refers to the cash flows that have impacted the elements of owner's equity.

Treasury policy may be considered "the heart" of the entire financial policy system, since different financial policies of the company may be accomplished only via treasury.

The requirement or consumption of resources within each type of financial policy represents a part of the treasury policy reflected in treasury surplus or deficit.

*Table 5. Financial policies*

Financial Policies	2010	2011	2012	2013	2014
Operating policy	443,314	511,988	495,293	146,537	- 709,954
Dividends Policy	52,514	48,630	55,218	31,068	0
Investing policy	-28,280,500	-28,085,267	-26,053,024	-25,801,989	-25,282,385
Financing policy	40,117,211	40,937,676	38,796,660	39,599,936	40,015,625
Treasury Policy	12,332,539	13,413,027	13,294,147	13,975,552	14,023,286

Source: Own calculus.

From the information above it can be noticed that in the period 2010-2013, SMEs registered working capital and paid dividends. In the same time, the SMEs had not enough own resources for investing. Therefore, they borrowed money from banks to cover their investments.

### 3. Conclusions

The research presented above tackles different types of financial policies that can be highlighted within the funds flow cycle.

This cycle has to be designed based on the treasury flows. Consequently, it can be stated that treasury is at the center of the company financial policy.

All financial policies are reflected in the cash flow statement: operating policies, investing policies, financing policies and dividend policies.

### 4. References

- [1] Bătrâncea, L., Bătrâncea, I., Moscviciov, A., "Treasury Flow Analysis in Romanian Companies", *International Journal of Business Research, International Academy of Business and Economics*, Vol. 9, No. 1, 2009, pp. 57-62.

- [2] Bătrâncea, L., Bătrâncea, I., Moscviciov, A., "The Analysis of the Entity's Liquidity - A Means of Evaluating Cash Flow", *Journal of International Finance and Economics*, Vol. 9, No. 1, 2009, pp.92-98.
- [3] Buckley, A., Buckley, P.J.S., Langevin, P., Tse, K.L., "The Financial Analysis of Foreign Investment Decisions by Large UK-based Companies", *The European Journal of Finance*, Vol. 2, No. 2, 1996, pp. 181-206.
- [4] Hendragunawan, M., Nur, A.S., "Financial Decision, Innovation, Profitability and Company Value: Study on Manufacturing Company Listed in Indonesian Stock Exchange", *Information Management and Business Review*, Vol. 7, No. 2, 2015, pp. 72-78.
- [5] Kung, C.Y., Wen, K.L., "Applying Grey Relational Analysis and Grey Decision-Making to Evaluate the Relationship between Company Attributes and Its Financial Performance - A Case Study of Venture Capital Enterprises in Taiwan", *Decision Support Systems*, Vol. 43, No. 3, 2007, pp. 842-852.
- [6] Huang, Y.H., Leamon, T.B., Theodore, K., Courtney, T.K., Peter, Y., Chen, P.Y., DeArmond, S., "A Comparison of Workplace Safety Perceptions among Financial Decision-makers of Medium - vs. Large-size Companies", *Accident Analysis & Prevention*, Vol. 43, No. 1, 2011, pp. 1-10.
- [7] Dündar, K., Ender, C., Serdar, I.M., "Differentiation and Mean Reverting Tendency in Working Capital Policies", *Business and Economics Research Journal*, Vol. 4, No. 4, 2013, pp. 49-70.
- [8] Kieschnick, R., Laplante, M., Moussawi, R., "Working Capital Management and Shareholders' Wealth", *Review of Finance*, Vol. 17, No. 5, 2013, pp. 1827-1852.
- [9] Baños - Caballero, S., García -Teruel, P.J., Martínez - Solano, P., "Working Capital Management in SMEs, *Accounting & Finance*, Vol. 50, No. 3, 2010, pp. 511-527.
- [10] Knauer, T., Wöhrmann, A., "Working Capital Management and Firm Profitability", *Journal of Management Control*, Vol. 24, No. 1, 2013, pp. 77-87.
- [11] Singhanian, M., Sharma, N., Rohit, J.Y., "Working Capital Management and Profitability: Evidence from Indian Manufacturing Companies", *DECISION*, Vol. 41, No. 3, 2014, pp. 313-326.
- [12] Etienneot, H., Preve, L.A., Allende, V. S., "Working Capital Management: An Exploratory Study", *Journal of Applied Finance*, Vol. 22, No. 1, 2012, pp. 161-174.
- [13] Radhika, R., "Working Capital Management in Bharat Heavy Electricals Limited", *International Journal of Applied Financial Management Perspectives*, Vol. 3, No. 3, 2014, pp. 1245-1254.
- [14] Helfert, E.A., *Techniques of Financial Analysis*, McGraw-Hill, New York, 1997.
- [15] Horne, J.C., "Financial Management and Policy", Prentice-Hall, Inc., Englewood Cliffs, New Jersey, 1980.
- [16] Bătrâncea, I., Bătrâncea, L., Bătrâncea, M., Borlea, S., Ardelean, V., Trifoi, I.G., "The Role of Cash Flows in the Financial Management of the Entity", *Annals of the University of Craiova, Economic Sciences Series*, Vol. 36, No. 1, 2008, pp. 34-40.
- [17] Moscviciov, A., Bătrâncea, I., Bătrâncea, M., Bătrâncea, L.M., "Financial Ratio Analysis used in the IT Enterprises", *The Annals of the University of Oradea, Economic Sciences*, Vol. XIX, No. 2, 2010, pp. 600-603.
- [18] Bătrâncea, I., Bătrâncea, L.M., Moscviciov, A., Popa, A., Bătrâncea, M., Nichita, A., *Standing Financiar*, Editura Risoprint, Cluj-Napoca, 2010.
- [19] Bătrâncea, I., Bătrâncea, L., Moscviciov, A., Ardelean, V., "Decisions Regarding the Financial Structure of the Company", *The Annals of the University of Oradea, Economic Sciences*, Vol. III, 2008, pp. 52-56.

## Financial Autonomy in Local Romanian Administration

Lucian Găban

*1 Decembrie 1918 University, Alba Iulia, Romania*

[gabanvasilelucian@gmail.com](mailto:gabanvasilelucian@gmail.com)

Liviu Bechiş

*West University "Vasile Goldiş", Arad, Romania*

[liubechis1960@yahoo.com](mailto:liubechis1960@yahoo.com)

### Abstract

*In this paper the authors present important aspects of local autonomy seen through the lenses of decentralization and regionalization. It shows that local finance can contribute to community development only to the extent that the law provides financial autonomy so that the administration can attract European funds for local projects.*

**Keywords:** local autonomy, local finance, income, expenses.

**JEL Classification:** H83.

### 1. Introduction

In the EU countries, local communities possess financial resources that are not adapted to the tasks they should serve, in the conditions of budgetary strictness and a local fiscal pressure which has reached a level considered excessive by taxpayers from all the countries. Therefore, central governments have to grant local authorities a higher autonomy and financial responsibility. The topic referring to local public finance is in the center of current political debates, because all member states of the European Council deal with the problem of harmonizing two major antagonistic trends: 1) controlling and reducing public outlays; 2) granting a higher autonomy to local communities.

All these states look for solutions of allocating as equitable as possible the financial resources among different levels of the administrative organization, taking into account budgetary strictness that has to characterize all the levels of public administration.

Therefore, financial autonomy of the

community entails creating systems of efficient local public finance, equitable and correlated with the necessities and politics of the national states. The objective of every system intended to finance local communities is to support them in fulfilling their obligations of public authorities. From the analyses conducted, we concluded that no system of local public finance is perfect. At local level, no tax, charging system or financial transferring is perfect. Moreover, a system that is effective in one country is not necessary adaptable for another country.

The paper tackles the topic of financial autonomy in the context of decentralization and globalization of the EU economies. It is structured in three parts: literature review, methods and results, conclusions.

### 2. Literature Review

In the last years, local finances have gained great importance in the economic and political areas of new EU countries. In his paper, Sauviant appreciates that increased local spending and the problem of determining their local resources are currently a major concern for all countries. On the other hand, the degree of decentralization of a country, the financial relations between the state and local administrations are multiple and complex and reflect the conflicting financial aspects of regionalization. That is why it must be recognized that the financial dimension is a complex area with many nuances [1].

In a recent study, Brothaler and Getzner analyze the tax effects of decentralization which lead to an increased public sector and consider local decisions as being the most important factor of spending and taxation. They tested the effects of fiscal autonomy of public expenditure based on data series from

1955 to 2007 in Austria and came to the conclusion that it is necessary that the local autonomy of currently existing tax offices in Austria to be widened [2].

So far, local financial resources have not been adapted to tasks that need to be faced in terms of budgetary rigor circumstances and overall tax pressure reached a level considered excessive by contributors from all countries. Therefore, the central government must offer administrations a greater local autonomy and financial responsibility.

### 3. Methods and Results

Issues related to local government finance are in central current policy debates because all member states of the European Council face problems of harmonizing the two divergent trends, namely:

- On the one hand, the control and the ability to reduce public spending;
- On the other hand, a large local financial autonomy.

All these countries are looking for solutions to ensure a balanced allocation of financial resources between the different levels of administrative organization, taking into account budgetary rigor that is required at all levels of government.

In some works many scholars argue that government reforms have affected the operation of various components of the public sector. Main problems are focused on the autonomy and control of these public organizations, their management, identity, role performance and its accounting and coordination of local organizations. From this point of view, autonomy is seen as the discretion used to take decisions in accordance with local policy [3].

Politicians often propose force strategies in fighting the underground economy in order to increase budget revenues: some advocate for trust-based strategies, some advocate for power-based strategies and others for an appropriate mixture of trust and power [4-8]. However, there are policies based on real decentralization and local autonomy involvement in combating this problem [9].

Other experts argue that autonomy can be accomplished through multi-agent management companies operating locally [10]. Financial autonomy is the sine qua non condition of administrative decentralization.

An important aspect in the analysis of fiscal decentralization is the balance between the power of local authorities and financial resources to exercise this power. But granted local financial autonomy may be accompanied by worsening the risk disparities between rich and poor communities in the whole territory or even within the same region. This could lead to a situation where local poorest cannot provide any minimum decentralized vital. Due to this reason is absolutely essential to appeal to different mechanisms such as balance, which is an indispensable mechanism, primarily aimed at redistributing wealth and reducing inequalities between local defaults.

Increased importance of local governments and provincial governments as providers of public services and the importance of these services in improving national economy leads to a review of the issue of resource allocation by the government. While the Tiebout model demonstrates the efficiency in allocating public resources, the conditions to implement this model (additional residential charges, reduced taxation of households) are rarely applied by local governments [11].

There are opinions that the "effective financial autonomy implies a degree of control by the local financial flows. It refers to the increasing local control over financial resources, either in terms of sharing expenses or income generation. However, the existence of financial independence should not prevent the emergence of territorial fracture risk" [1].

As a result, the financial autonomy of local community involves the creation of effective local public finance systems, fair and related to the needs and policies of nation states. The objective of any system of local funding is to help them to fulfill their obligations as public powers. From our analysis we found that no system of local public finance is perfect. Moreover, local, no tax, no tariff or financial transfers is perfect. Moreover, a system that is effective in one country is not necessarily adapted to another country.

However, although there is a universal ideal on local funding, there are certainly some principles presented in The European Charter of Local Autonomy.

Whenever possible, local subsidies should not be destined to finance specific projects. Award of grants shall be done without prejudice free of policy by local authorities in their own field of expertise.

In order to finance investment spending, local access must be in accordance with the law to the national capital.

Therefore, financial autonomy of local authorities is based on two conditions:

► On a legal requirement, which consists of recognizing the free decision-making power of local authorities, power should not be hindered by a very strict control of the state;

► On a physical condition, authorities must cover local expenses from their own resources and without being obliged to call on transfers from the state budget to balance their budgets.

These conditions are interrelated to each other (even if they pose different natures): on the one hand, by the amount of own resources needed for financial independence which depend largely on the legal capacity of local authorities to enforce freely the introducing of new local taxes, to establish base rates tax; on the other hand, by the power to grant exemptions from taxes or change the tax base freely and thus influence the costs that may incur to the collectivity.

However, a local material independence does not result solely from its ability to act in terms of the costs and financial resources. A number of other conditions have to be considered, like:

■ own resources may be influenced by constitutional guarantees, game or physical and economic characteristics of the tax base;

■ the amount of expenditures is strongly conditioned by transfer powers offered by the state, without granting financial compensation equivalent to his part.

The degree of local autonomy (and thus financial) of a community is closely related to the share of own revenues in total revenues of local budgets. Still, this criterion should not be generalized, since there are exceptions for European countries with a highly developed local democracy, but with a centralized system of local government finance. In order to determine whether a country's economy will be affected by high levels of debt, in the event of external economic and financial shocks, we

introduced a set of indicators. They are both indicators of public debt (level, structure and dynamics) and reserve adequacy indicators.

If endowed with decentralized powers, local authorities should be able to judge their financial options, but shouldn't be checked for technical assistance by the state or other authorities. Decentralized communities must be able to freely decide their level of spending without being unduly constrained in terms of the resources.

Therefore, revenues and expenses must be adapted to their own requirements that do not lead to violations of administration freedom.

Regarding expenses, classical dichotomy between mandatory spending and other spending heavily influences the reality of financial autonomy. Therefore, these costs are considered binding by the central state to be consistently funded without affecting freedom of local administration.

Given the scope of competences (education, social action, environment, transportation, economic development, urban planning, etc.), European local authorities contribute increasingly active in regional development and economic growth of their countries. At European level, local economic actors are genuine, GDP per capita in these regions was in 2009 at an average of 23,500 Euro.

However, discrepancies remain between European regions at the lowest level in Severozapaden in Bulgaria (27%), at the highest level in the capital of Inner London with a value of 332% compared to the EU-27, followed by Luxembourg (26 %), the Belgian capital region (223%) and the region of Hamburg in Germany (188%). In Romania, the region Bucharest-Ilfov is well placed with an average GDP per capita of 111% compared to the European average.

Another indicator which highlights the importance of regionalization refers to the number of inhabitants in regions with a GDP that is 75% below the average GDP per capita in the EU-27. Thus, according to the latest data published in 2009, 23.3 % of EU regions is within this range, while 19% of the population lives in regions with a GDP per capita of 125% compared to the EU average.

In Romania, Slovakia, Poland, Czech Republic, Bulgaria, Hungary, Portugal and Slovenia, more than half of the population

lives in regions with a GDP per capita below 75% of average EU-27. Croatia, the last country to join the EU, also falls into this category.

At European level, the share of employees aged between 20-64 years decreased from an average of 70.4 % in 2008 to 69.1% in 2009, declining numbers being recorded for the first time in five years, compared with the target of 75% provided for 2020. For developing regions, the situation is as follows:

- 74 of the 271 NUTS 2 regions will have achieved the target set for 2020.
- the lowest number of employment weights were recorded in southern Spain, southern Italy, Greece, Poland, Hungary, Bulgaria, Romania and Malta.

Labor cost varies from one region to another. Thus, in 2008, the highest values were recorded in the Île-de-France near Paris with 49 Euros per hour, a value that is 25 times higher than in Bulgaria where labor cost is 2 Euros per hour. Other new regions have higher values as follows: 44 Euros per hour in the Brussels region Hoofdstedelijk Gewest, 38 Euros per hour in Norway, 37 Euros per hour Ostra region Sverige in Sweden, 36 Euros per hour in Denmark, 35 Euros per hour in Hessen region of Germany and 33 Euros per hour in the Wallonne region of Belgium and Bassin Parisien in France. At the bottom of the league with an average cost of labor under 6 Euros per hour are 11 regions: Hungarian Alföld es Eszak, Wschodnia region in Poland, Lithuania, Latvia, regions Macro three and Macro four in Romania, Yugozapadna I Yuzhna Tsentralna and region Severna I Iztochna in Bulgaria.

Search quality and relevance of public action should not be impeded by financial constraints that cannot be attributable to local communities. Thus, any transfer of responsibilities from the state to local communities must be accompanied by equivalent and simultaneous transfer of financial resources. So, this transfer of resources must match the actual cost of exercising the new powers transferred. Communities must therefore receive sufficient scope, so the real financial autonomy for these charges can be achieved, which become the true stakes of successful decentralization.

#### 4. Conclusions

Undoubtedly, the concept of local autonomy is doomed to remain empty as long as local authorities do not have the material resources, legal powers and the political authority they need to effectively assume the responsibilities granted to them by this autonomy.

Financial resources of the administrative units consist of: taxes and other tax revenues; non-tax revenues; capital revenues; shared amounts of certain revenues from the state budget; additional quotas on certain revenues from the state budget and the local budgets; special purpose transfers from the state budget for social and income expenses [12].

Transferring the public spending system from the government to local authorities as a result of their decentralization is achieved by law, financial resources being the only ones needed to achieve this purpose.

Financial administrative units are an integral part of the Romanian financial system and even elements of the vast area of public finances, they cannot be considered, however, as a secondary branch thereof. On one side, local decentralization produces effects in the structure and functioning of the public apparatus; on the other hand, it impacts local funding and practically comes to complement the real size.

Thus, we adhere to the opinion of other specialists that decentralization exists when local authorities are in control of their own financial resources and, on the contrary, decentralization is only apparent if local communities have real financial autonomy, even if granted extensive legal skills. In fact, the degree of public finance autonomy is a gauge of genuine decentralization [13].

#### 5. References

- [1] Sauviant, A., "L'Autonomie Financière et Fiscale des Collectivités Locales en Europe. Approche Théorique", in H. Pauliat (Ed.), "L'Autonomie des Collectivités Territoriales en Europe - Une Source Potentielle de Conflits?", Presses Universitaires de Limoges, Limoges, 2010.
- [2] Bröthaler, J., Getzner, M., "Fiscal Autonomy and Total Government Expenditure: An Austrian Case-study", *International Advances in Economic Research*, Vol. 17, No. 2, 2011,



- pp. 134-156.
- [3] Laegreid, P., Verhoest, K., Jann, W., "The Governance, Autonomy and Coordination of Public Sector Organizations", *Public Organization Review*, Vol. 8, No. 2, 2008, pp. 93-96.
- [4] Bătrâncea, L., Nichita, A., "Which is the Best Government? Colligating Tax Compliance and Citizens' Insights regarding Authorities/ Actions", *Transylvanian Review of Administrative Sciences*, No. 44 E, 2015, pp. 5-22.
- [5] Kogler, C., Batrancea, L., Nichita, A., Pantya, J., Belianin, A., Kirchler, E., "Trust and Power as Determinants of Tax Compliance: Testing the Assumptions of the Slippery Slope Framework in Austria, Hungary, Romania and Russia", *Journal of Economic Psychology*, Vol. 34, 2013, pp. 169-180.
- [6] Bătrâncea, L., Nichita, A., Bătrâncea, I., "Tax Non-compliance Behavior in the Light of Tax Law Complexity and the Relationship between Authorities and Taxpayers", *Scientific Annals of the "Alexandru Ioan Cuza" University of Iasi. Economic Series*, Vol. 59, No. 1, 2012, pp. 97-106.
- [7] Bătrâncea, L. Nichita, A., Bătrâncea, I., "Understanding the Determinants of Tax Compliance Behavior as a Prerequisite for Increasing Public Levies", *The USV Annals of Economic and Public Administration*, Vol. 12, No. 1, 2012, pp. 201-210.
- [8] Batrancea, L., Nichita, R.A., Batrancea, I., Pop, R., "Multifacets of Tax Evasion in Theory, Surveys, Case Studies, and Economic Experiments", *Advances in Finance and Accounting*, Proceedings of the 1<sup>st</sup> WSEAS International Conference on Finance, Accounting and Auditing (FAA'12), 2012, pp. 378-383.
- [9] Torgler, B., Schneider, F., Schaltegger, C., "Local Autonomy, Tax Morale and Shadow Economy", *Public Choice*, Vol. 44, No. 1-2, 2010, pp. 293-321.
- [10] Villa, A., "Autonomy versus Efficiency in Multi-agent Management of Extended Enterprises", *Journal of Intelligent Manufacturing*, Vol. 13, No. 6, 2008, pp. 429-438.
- [11] Inman, R. P., "Transfers and bailouts: Institutions for Enforcing Local Fiscal Discipline", *Constitutional political Economy*, Vol. 12, No. 2, 2001, pp. 141-160.
- [12] Sosotean, A., Popovici, D., *City Halls Accountancy in Current Market Economy*, Editura Amacord, Timișoara, 2000.
- [13] Inceu, A.M., Lazăr, D.T., *Finanțe și Bugete Publice*, Editura Accent, Cluj-Napoca, 2006.

# The Relation Corporate Governance - Financial Communication - Social Responsibility to the Level of the Group of Companies

Claudia Nicoleta Guni  
"Spiru Haret" University, Constanta  
[borsanclaudia@yahoo.com](mailto:borsanclaudia@yahoo.com)

## Abstract

*The financial communication is a complex process that has evolved in recent decades from the mandatory financial reporting to the voluntary reporting of financial, non-financial, strategic information and also regarding the performance of the entity. The corporate communication is essential for the effective functioning of the capital market. The accounting information communicated by the companies is one of the most valuable information for investors and analysts when evaluating a company.*

**Key words:** words stakeholder, agency's theory, signaling theory, corporate philanthropy

**J.E.L. classification:** G3; G32; G34

## 1. Introduction

The informational needs of modern stakeholders, nowadays, are much more sophisticated, pretending much more information than those offered by the financial statements. These stakeholders assess the company not only in terms of financial information, but also in terms of non-financial and strategic performance. The annual reports of the companies are seen as primary sources of the information reporting. In addition to the mandatory information, the annual reports can provide voluntary information, rendering them important sources of financial and non financial communication [1]. The efficiency of the communication process is dependent on the needs of the stakeholders and the interests of the companies' management. Therefore, communication is a crucial element in ensuring the effective allocation of resources in the entity and in the decrease of

information asymmetry in between the company and the stakeholders.

## 2. The concept of corporate governance

The corporate governance should be seen as a process in which the organization is involved in general and it refers to all internal components working together that will eventually be integrated into a single recognized management structure [2]. On the other hand, in the 1992 Cadbury Report, Sir Adrian Cadbury defined the corporate governance as the system that guides and controls companies [2]. The Cadbury Code established for the first time the basic rules of running a campaign to achieve efficiency, concomitant with a non discriminatory behavior towards shareholders. The Cadbury report series that began in 1992, admitted the need to establish some audit committees, the widespread use of non-executive directors that do not have managerial responsibility within the company.

In recent decades, studies in the specialty literature have been much more interested in the motivations of the companies that communicate information. The practice of voluntary information reporting is generally explained by two fundamental theories: agency's theory and signaling theory. The voluntary disclosure of information is oriented towards informational problem solving and the agency's problems simultaneously. Agency's theory assumes that everyone is selfish and pursues to fulfil his own interests, hence resulting the informational asymmetry, the most frequent being the one between managers and shareholders or between managers and creditors. The agency conflict causes problems as it concerns the period after the investment in the company or finding sources for development. The signaling theory

manifests before the investors take the decision to invest in the company. Therefore, it generates information problems. These problems exist because the investors do not have or have limited information on the qualitative assessment of the company, forcing them to evaluate the company at an average level [3]. On the capital markets occur decisions that investors need to take under risk and uncertainty. Communicating more financial and nonfinancial information to potential investors may reduce the information asymmetry. Under the pressure of various players, the entities engage nowadays in information policies to meet the new requirements. Beyond the financial statements, it appears that the annual reports, but also the intermediate ones, bring an increasingly richer information offer [4]. This offer can meet the needs of governance by completing an administrative report and by describing the main control bodies of the enterprise.

### **3. Corporate governance objectives**

The corporate governance does not represent a concept applicable only to the individual enterprise level, it also extends to the group of companies, where the complexity of the links between companies and of the activities performed, involves a high degree of responsibility of the managers towards the owners [4]. The corporate governance has its roots in the corporate mechanisms and in the bankruptcy laws in each country, and in the judicial enforcement mechanisms that establish basic rules of the internal relations between various participants in a corporation. The implementation method of the corporate governance varies significantly from country to country and from company to company. An efficient implementation of the governance allows companies an easy access on the capital markets, access that is required in order to obtain financing, given that growth opportunities can be financed domestically [3].

The overall objective of any government is to ensure the balance of power between different actors participating, and commissioning these control tools for both shareholders participating in intangible capital and for other participants to this

equity. The corporate governance nowadays, assumes treating complex contemporary issues by teamwork where everyone contributes. A strong governance assumes the establishment of some fundamental principles that define the relationships between different actors, clearly outlines the responsibilities and guarantees the correct function of the decision-making processes. The governance systems actually have two main objectives: ensuring the integrity of management and its orientation to maximize the value created for shareholders or stakeholders [3].

The signaling theory may be relevant in the analysis of the determinant factors in choosing accounting policies and procedures. Moreover, the choice of accounting policies results from the desire to respect the spirit of the regulations or standards, or to reflect the economic reality of the company or to give a true and fair view. It is quite clear that the selection of accounting policies transmits signals to the stakeholders. In the decision process of the managers interfere other factors as well, among which the governance mechanisms. To the extent that these mechanisms are partly based on accounting information, selecting different accounting policies, managers can influence the effectiveness of the governance arrangements [1]. The acquisition of resources and maintaining at a positive level the economic indicators, such as the share price, are elements that strongly motivate the managers to voluntarily disseminate the financial and nonfinancial information. This is essentially achieved by implementing a policy of signaling or warning.

### **4. Corporate governance practices and structures**

Starting 1990, more and more entities, particularly groups of companies, were engaged in promoting social responsibility, by internalising externalities and by voluntary initiatives for environmental protection. Due to the growing importance of social responsibility, corporate governance begins to be seen from a different perspective, namely that of the stakeholder's theory, as a set of relationships between the company and all concerned stakeholders, being that governance, which ensures the

legitimacy of the entity [4]. The most common definition, in the specialty literature, of the concept of social responsibility, belongs to the European Commission. According to this definition, social responsibility is a concept by which the entities integrate voluntarily, social and environmental concerns in their business operations and in their interaction with stakeholders [2]. Corporate social responsibility is closely linked to the globalization of the business environment and still considered the prerogative of multinationals. Corporate social responsibility is understood as a voluntary corporate commitment to overcome the explicit and implicit obligations imposed on companies by social expectations regarding conventional corporate behavior. The basic premises from which starts the corporate social responsibility is that the profits, people and the environment can be harmonized in a strategic corporate approach, so that the company becomes economically viable, socially responsible and careful to ecological issues [3]. The duty of the managers of a company is to make as much money respecting the basic rules of society, both those encoded in laws and the moral norms included, which implicitly means that the economist accepts economic, legal and ethical responsibilities of the business organizations. Thus, in the 70s, the authors in the specialty literature start to adopt a broader perspective on the social responsibilities of a company, focusing at first on the economic and legal aspects, and later on the ethical and discretionary ones. Later, in the 90s, there was a change in the approach of social commitments by the companies. Some authors identify this change as being the transition from a traditional approach of the corporate social responsibility, by the strict fulfillment of a social obligation, to a strategic one, by complementary supporting the business objectives, in other words, the transition from the deontologic ground to the pragmatic one [4].

The significant differences in the approach of the corporate social responsibility in the specialty literature, are generated by the significantly different perception of the authors on the company's responsibilities to society. Thus, the main

debate in this area refers to two distinct concepts [2]:

- The corporate social responsibility perceived as obligation or moral duty to a wider or narrower range of interest groups;
- The corporate social responsibility as a voluntary initiative undertaken by companies in order to achieve social and economic objectives.

The community volunteering programs supported by companies generate various corporate economic benefits, that build strong and lasting relationships with local communities, attract and keep employees motivated, enhance the current corporate involvement and the investments in social initiatives [5]. The issues related to the development and implementation of voluntary schemes are also quite large and aim, in particular, the problem of high costs and achieving a significant social impact. Some authors consider the corporate social responsibility a corporate commitment to enhance the community's well-being by means of some discretionary business practices and corporate resource allocation.

The corporate social responsibility includes three interconditioned aspects: a definition of all the social responsibilities of a company, a list of the aspects covered by the corporate social responsibility and a specification of the philosophy of corporate social pressures. So, there are multiple perspectives that the society has on the responsibilities attributed to a business organization [4]. The corporate social responsibility covers a whole range of social obligations that business organizations have towards society, as a whole: economic, legal, ethical and discretionary responsibilities. The four types of comparative responsibilities do not exclude each other and they do not have to be analyzed as distinct segments of the corporate social responsibility, as any act or practice of a company can be based simultaneously on economic, legal, ethical or discretionary grounds, one of the four dimensions being prevalent in a particular situation and in a given context [1].

The specialty literature presents six corporate social initiatives where the activities undertaken by a company materialize, to support social causes and to fulfill its commitments of corporate social

responsibility assumed. These represent the forms of the corporate social responsibility: the corporate promoting of some social causes, the marketing associated to some social causes, the corporate social marketing, the corporate philanthropy, the community volunteering and the socially responsible corporate practices [5].

Regarding the consolidated financial statements of the company, they are audited by one or more individuals or legal entities authorized by law. The person or persons responsible for auditing the consolidated annual financial statements, referred to as statutory auditors, also express an opinion on the level of compliance of the consolidated report of the administrators with the consolidated annual financial statements for the same financial exercise.

In recent decades, the corporate governance is the concept that has affected most of the already developed and developing countries [3]. OECD published in 1999, as an argument, "The Corporate Governance Principles", including the principles referring to the issues where the administrators have a key role: the rights of shareholders, the fair treatment of the shareholders, the role of the shareholders in the corporate governance, the communication of financial information and its transparency, the responsibility of the Board of Directors.

The European Commission highlighted the main instruments of the corporate social responsibility, namely: the corporate conduct codes, the management standards, the reporting of corporate social involvement, the environmental and social labels and the socially responsible investments. We notice that the social responsibility depends on the corporate governance, being an optional management strategy, profitable, to the extent that it generates long-term credibility and trust necessary for a company in dealing with all the players involved [3].

Applying the principles of corporate governance has visible benefits on the companies that adopt them, generating competitive economic advantages. Corporate governance is often considered difficult because it involves changing the constitutive document of the company. The governance should also be supported by a well established control system.

Taking into consideration those rules, the

corporate governance norms that constitute the theoretical and legal framework of carrying out the mechanism that directs and controls entities, it is worth noting that in the European Union there have been adopted a number of 35 corporate governance codes, each country having at least one code. Most of these codes were issued after 1997, after financial scandals and bankruptcies of British companies listed on the stock market [5]. Approximately one third of the codes, applicable in EU countries, have been elaborated by groups or associations of investors. These codes applicable in the EU are different, due to the purpose they have been issued for and their detailing degree. They address the following issues: fair treatment of all shareholders, whose interests should be a priority; the clear responsibility of the Board of Directors and management; the company's transparency or the accuracy of the financial and non-financial reporting; the responsibility for the minority shareholders' interests and of other social partners, as well as the compliance with the law. The corporate governance codes provide flexibility and they are not compulsory, even in the case when the principle "comply or explain" applies, the companies are free not to follow the recommendations of the codes provided they report and explain their failure. However, the fact that they are not compulsory raises the question of their effectiveness in practice [5]. The corporate governance may reduce the agency's problems, adopting mechanisms to monitor the managers' activity. This should lead to, on one hand, a higher operational performance, as long as the managers are encouraged to invest in projects with a positive present value, and, on the other hand, to an increase in the value of the company, as the investors realize that much of the cash flows of the company returns to them. In countries like the United States of America, United Kingdom or Japan, the concentration of capital has an either positive or negative effect on the performance. An impressive number of studies in the specialty literature investigates, lately, the relationship between corporate governance and the companies' value or the performance of companies, identifying mixed results. For the emerging countries, the results indicate that the corporate governance is in a significant

positive correlation with the value of the company, but in order to establish the relation with the profitability, the results are not conclusive [1]. For the developed countries, the results are even more controversial. Some authors identify a low record of the correlation between the corporate governance and the value of American companies while other authors argue a strong correlation between governance and the companies' performance. A key issue in the study of the relationship between the corporate governance and the company's performance is the causality.

## 5. Conclusions

In order to assess the performance of a company and its ability to continue to produce wealth and value, there must be used tools that require orientation towards the sources and origins that create value. From the point of view of the shareholder, a company is efficient if it creates value. The financial indicators used to measure the performances of the groups of companies have a wide range, the most frequent classification being, classical and modern indicators of which a special significance, nowadays, is that of the value creation indicators.

## 6. References

- [1] Jianu I., *Evaluare, prezentarea și analiza performanței întreprinderii – o abordare prin prisma Standardelor internaționale de Raportare Financiară*, CECCAR Press, Bucharest, 2007
- [2] Ghiță M., *Guvernanța corporativă și auditul intern*, Mirton Press, Timișoara, 2009
- [3] Feleagă L., Feleagă N., *Guvernanța întreprinderii, pârgăie indispensabilă a politicii de maximizare a bogăției acționarilor și complementele ei contemporane*, Economie Teoretică și Aplicată Press, nr.8, Bucharest, 2006
- [4] Ienciu A.I., *Implicațiile problemelor de mediu în contabilitate și auditul situațiilor financiare*, Risoprint Press, Cluj-Napoca, 2009
- [5] Iamandi I.E., Filip R., *Etică și responsabilitate socială corporativă în afacerile internaționale*, Economică Press, Bucharest, 2008

## The Monetary Transmission in the Selected CEE Countries

Eliška Horká

Mendel University, the Czech Republic

[horka.eliska@gmail.com](mailto:horka.eliska@gmail.com)

### Abstract

*The paper evaluates similarity of transmission mechanisms of the CEE countries and the Euro zone. Comparison of transmission mechanisms is conducted using VAR model and impulse response functions of main economic variables to an unexpected monetary policy tightening. An unexpected rise in interest rates is followed by a fall in output, other reactions usually differ for CEECs and the Euro zone members. The price puzzle still occurs in the CEE economies. Different reactions are reason for careful consideration of the Euro adoption.*

**Key words:** monetary policy, transmission mechanism, VAR model, impulse response

**J.E.L. classification:** E52, E37

### 1. Introduction

Integration of European countries and enlargement of European Union brings a question of the Euro zone enlargement. Slovenia, Slovakia, Lithuania, Latvia and Estonia use the euro. The Czech Republic, Poland, Hungary and Romania are EU members but do not meet convergence criteria. The transmission mechanism of monetary policy has implications for euro adoption and proper functioning of a monetary union. The cost of losing monetary policy independence can be considerable when the effect of domestic monetary policy on inflation and output differs significantly from the effects observed in the Euro area. The similarity of the transmission mechanism across member states of the Euro zone is then very important. This paper studies the transmission of monetary policy in selected CEE countries in comparison with selected euro area members using VAR model and impulse response functions.

### 2. The theoretical approach to the monetary transmission mechanism

Genev et al. [1] focuses on the transmission mechanism in ten CEECs. Exchange rate channel and interest rate channel are easily identifiable and operating in all tested countries. The exchange rate channel is for most countries stronger and more stable than the interest rate channel. Investigation of impulse response functions show that inflation is raised by exchange rate depreciation and reduced by interest rate rise. The output is raised by depreciation in majority of countries while other reactions vary by the country. Garbuza [2] conducted analysis for Poland which is a representative example of CEE transition economies. According to his analysis, a contractionary monetary policy shock leads to a fall in industrial production and consumer prices (temporary price puzzle lasts for about 3 months). Both interest rate and exchange rate respond positively to monetary policy shock with not significantly different responses so both channels of monetary transmission are relatively equal in strength. Héricourt [3] studied eight CEECs integrated to EU. The exchange rate channel plays important part for transmitting monetary policy but it is declining relatively to interest rate and credit channel. Monetary policy transmission mechanisms for all countries present similarities with the old euro area members.

The transition mechanism of the Euro area members studied Angeloni et al. [4] Euro area wide monetary policy responses for prices and output are similar to those reported for the U.S. An unexpected increase in the short-term interest rate temporarily reduces output with the peak effects after approximately one year. Prices respond more slowly. Inflation is hardly moving during the first year and then fall gradually over the next few years. The interest rate channel or a broadly construed financial channels are not

exclusively dominant but the interest rate channel is for most countries still important in transition with sizeable effects. Boivin et al. [5] characterised the transmission mechanism across countries of the Euro area and its changes after the introduction of the euro. There was heterogeneity across countries in the effect of monetary policy shocks before the launch of the euro. The creation of the euro has contributed to a greater homogeneity of the transmission mechanism across countries and to overall reduction in the effects of monetary shocks. The exchange rate channel has become relatively more powerful in the monetary union period than in the previous decade. The paper of Ciccarelli and Rebucci [6] shows that a long run cumulative impact of monetary policy shock on output has decreased in all tested countries after 1991. This changes are associated with shifts in the behaviour of the monetary authorities. The cross-country differences in the effects of the shock have not decreased over time. Al-Eyd and Berkman [7] deal with the transmission mechanism during the crisis. The euro area financial markets have remained fragmented and retail interest rates in stressed markets were above those in the core. This impeded the flow of credit and undermined the transmission of the monetary policy. The credit channel of monetary policy has broken down during the crisis.

Darvas [8] studies the transmission of monetary policy in three new EU member states in comparison with the Euro area countries. In the Euro area, the impact on output of a monetary policy shock has decreased in time while in the new EU states both decrease and increase can be observed. The largest Czech impulse response can be observed in 2000Q1 while the effects decline since then. The price-puzzle appears up to 2004. In Hungary the shock had only a tiny effect on output in the period 1996 – 2004 and by 2008 the effect increased. The real exchange rate depreciated after a monetary policy shock. Monetary policy became more effective in Poland. The output response became weaker in the Euro zone, stronger in Hungary and monotonous in Poland. The strength of the Polish response was at the end of tested period comparable to the Euro zone reaction. Sander and Kleimeier [9] investigate interest rate pass-through for

eight Central and Eastern European countries. The pass-through in many CEECs is more complete and faster than in the Euro zone. Most pass-through differences within the CEECs can be explained by financial structure variables and macro-controls. There might be potential for emerging homogenous transmission mechanism across CEECs. The authors did not find evidence for convergence towards the Euro zone but it is not necessary a problem.

### 3. Methodology and model description

In this paper is used vector autoregression (VAR model) which is the most widely used tool for estimating the effects of monetary policy on output and prices, i.e. the analysis of the monetary transmission mechanism. The VAR model and related impulse response functions are estimated for tested CEE countries (the Czech Republic, Poland, Hungary, Slovenia, Slovakia, Lithuania, Latvia and Estonia) and for a representative example of the Euro zone members (Germany and Spain).

Variables are selected according to similar paper, e.g. Arnoštová and Hurník [10], Darvas [8], Majon and Peersman [11].

Majon and Peersman [11] divided tested countries in three groups to fit the individual country experience. In this paper is modified the vector of exogenous variables for each country. Using of exogenous variables helps to solve price puzzle problem (the increase of interest rate is followed by rise of inflation). The modified VAR models contains the GDP of the most important export partner and short-term interest rate of the most important export partner or of the Euro zone.

The vector of endogenous variables consists of consumer prices, interest rates, GDP and exchange rate. Used data are monthly series from 1Q 2000 to 1Q 2014 and its source is the Eurostat. Consumer prices are represented by HICP all items, reference year 2005. Interest rate is three month interbank interest rate and exchange rate is real effective exchange rate (deflator consumer price indices, reference year 2005). GDP data are seasonally adjusted and adjusted by working days (index with reference year 2005).



#### 4. Results and discussion

The unexpected increase in the short-term interest rates reduce output in all tested countries and the effects fully disappear after ten quarters. Similar results show papers focusing on CEECs of Darvas [8], Arnoštová and Hurník [10] and for some countries Genev et al. [1]. The same reaction appears in papers focusing on the Euro zone of Majon and Peersman [11], Angeloni et al. [4], Peersman and Smets [13].

Impulse response functions show that inflation was reduced by interest rate rise in Slovenia, Germany and Spain with the peak effect after one quarter. In the Czech Republic, Hungary, Poland, Estonia, Lithuania and Latvia appears price puzzle effect, i.e. prices increase after unexpected interest rate increase. The price puzzle appears also in papers of Genev et al. [1], Darvas [8] and Creel and Levasseur [14].

Unexpected exchange rate shock reduced output in the Czech Republic, Hungary, Poland, Estonia and Lithuania. In Germany, Spain, Latvia, Slovenia and Slovakia is exchange rate depreciation followed by output increase. Exchange rate shock reduces inflation in Poland, Slovenia, Slovakia, Estonia, Lithuania, Hungary and the Czech Republic. In other countries is inflation increased by unexpected exchange rate shock.

Impulse response functions of tested countries which joined the European Union in 2004 and 2007 (the Czech Republic, Hungary, Poland, Slovenia, Slovakia, Latvia, Lithuania and Estonia) show similar reactions to unexpected monetary policy shock, i.e. unexpected rise in interest rates is followed by fall in output and increase in inflation (price puzzle) and appreciation.

Very similar are reactions of tested countries which are not members of the Euro zone (the Czech Republic, Hungary and Poland). After unexpected rise in the interest rate occurs fall of output, increase in prices and appreciation. The unexpected shock in exchange rate is followed by fall of output, inflation and interest rates.

Similarities can be found in reaction functions of Germany, Spain and Slovenia (joined the Euro zone in 2007). The unexpected rise of interest rates reduces output and inflation. Reaction on the

unexpected shock of exchange rate is similar for Germany, Spain and Latvia where the shock is followed by increase of output, inflation and interest rates. These three countries are relatively closed (ratio of export to the GDP [12] is less than 60 %).

#### 5. Conclusion

This paper compares reaction functions of Central and Eastern European countries and selected countries of the Euro zone using data from 2000 to 2014.

In all tested countries contractionary monetary policy shock leads to a fall in output. The interest rate as the monetary policy tool used by central banks has the same effect in all tested countries.

Reaction of inflation differs. The inflation is decreased by a monetary policy shock in Germany, Spain and Slovenia. In new member states of the Euro zone and non-members is the unexpected rise in the interest rates followed by inflation increase (price puzzle). The price puzzle often occurs in transition economies.

The impulse response functions show different reactions for the Euro zone non-members (the Czech Republic, Hungary and Poland) and for the Euro zone members.

The similar reactions of output across tested countries are argument for enlargement of the Euro zone but different reactions of other variables require more careful approach. In many Central and Eastern European countries still occur price puzzle.

#### 6. Acknowledgements

I am thankful to Ing. Petr Rozmahel, Ph.D. for comments and suggestions. This paper was realized with financial support of project MENDELU IGA PEF\_TP\_2015\_011.

#### 7. References

- [1] Genev, G. Y., Molnar, K., Rybinski, K., Wozniak, P. *Transmission mechanism of monetary policy in Central and Eastern Europe*. CASE Network Reports, (52). 2002.
- [2] Garbuza, Y. *The Transmission Mechanism Of Monetary Policy: Investigating The Exchange Rate Channel For Central And Eastern European Countries*. National University of

- "Kyiv–Mohyla Academy", MA thesis. 2003.
- [3] Héricourt, J. *Monetary policy transmission in the CEECs: revised results using alternative econometrics*. Maison des Sciences Économiques. 2005.
- [4] Angeloni, I., Kashyap, A. K., Mojon, B., Terlizzese, D. *Monetary Transmission in the Euro Area: Does the Interest Rate Channel Explain All?* Working Paper No. 9984. National Bureau of Economic Research. 2003.
- [5] Boivin, J., Giannoni, M. P., Mojon, B.. *How has the Euro changed the Monetary Transmission?* Working Paper No. 14190. National Bureau of Economic Research. 2008.
- [6] Ciccarelli, M., Rebucci, A. *Has the transmission mechanism of European monetary policy changed in the run-up to EMU?* European Economic Review, 50(3), 737-776, 2008.
- [7] Al-Eyd, A., Berkmen, S. P. *Fragmentation and Monetary Policy in the Euro Area*. Working Paper WP/13/208. International Monetary Fund. 2013
- [8] Darvas, Z. *Monetary Transmission in Three Central European Economies: Evidence from Time-Varying Coefficient Vector Autoregressions*. Discussion papers MT-DP 2009/13. Institute of Economics, Hungarian Academy of Sciences. 2009.
- [9] Sander, H., Kleimeier, S. *Convergence of interest rate pass-through in a wider Euro zone?* Economic Systems, 30(4), 405-423. 2006
- [10] Arnošťová, K., Hurník, J. *The Monetary Transmission Mechanism in the Czech Republic (evidence from VAR analysis)*. CNB Working Paper 4/2005.
- [11] Mojon, B., Peersman, G. *A VAR description of the effects of monetary policy in the individual countries of the euro area*. ECB Working Paper No. 92. 2001.
- [12] Eurostat. *Database* [on-line]. © Eurostat 2015 [cit. 2015-10-11] dostupné z <http://ec.europa.eu/eurostat/data/database>
- [13] Peersman, G., Smets, G. *The monetary transmission mechanism in the euro area: More evidence from VAR analysis*. ECB Working Paper No 91. 2001.
- [14] Creel, J., Levasseur, S. *Monetary policy transmission mechanism in the CEECs: How important are the differences with the euro area?*. OFCE, N° 2005-02.

## Indicators of Current Assets that Succinctly Express the Performance of Their Use

Mihaela Loredana Lăpăduși

*"Constantin Brâncuși" University of Tg-Jiu, Faculty of Economic Science*  
[lapadusi.mihaela@yahoo.com](mailto:lapadusi.mihaela@yahoo.com)

### Abstract

*The analysis of current assets is ment to characterize the performance of their use. Regarded as synthetic performance indicators which reflect changes in operational and financial activity of the company, they synthesize aspects of the deployment process of sourcing, manufacturing, cost reduction, etc.*

*The main indicators used to analyze the performance of current assets are: the speed of rotation, the profitability of current assets, the profitability of current assets related to a circuit, the current assets of 1,000 lei turnover, current assets of 1,000 lei production as well as the relative and absolute release.*

*The purpose of this article is to summarize the indicators used in performance analysis of current assets and the method of their calculation and the purpose of this research is to achieve the following goals: theoretical presentation of current assets indicators, the calculation methodology, their implementation in a company, the conclusions arising out of the investigations.*

**Key words:** *performance, current assests, the speed of rotation, profit, turnover*

**J.E.L. classification:** D2

### 1. Introduction

To assess the economic and financial performance of a company, several categories of indicators, both quantitative and qualitative pursuing all aspects of its business should be taken into consideration. [1]

Due to the fact that current assets involve the use of an intangible resource, we need to consider their efficient use thereof. From this

point of view the performance of using the current assets is one of the most important aspects in developing the economic and financial activity of a company.

The assets of a firm are a category of resources that should lead to obtaining future benefits and are divided into two categories: current assets and fixed assets. As it is known the current assets are the assets with a life expectancy less than one year being used within a single economic circuit and the fixed assets are those with a life expectancy more than one year and can be used in several economic circuits.

### 2. Indicators used in analysing the performance of current assets

The indicators of current assets are indicators expressed by the ratio of two sizes that allow the use of performance assessments on current assets and which have direct effects on the economic and financial performance of the company.

The current assets constitute the material support for conducting an operational activity, for creating values for consumption, whatever the specifics of the company is: manufacturing, services and trade. [2]

#### 2.1. Indicators of rotational speed of current assets

The rotational speed of current assets is a significant indicator which characterizes the efficiency of current assets of the company. The higher the rotational speed is, the lower the volume of current assets to achieve certain production is; the production obtained in a certain period of time with the same volume of current assets is higher. That is why we need to accelerate the speed of rotation in order to increase the overall efficiency of the economic activity of the enterprise. [3]

The main indicators which highlight the speed of rotation of the current assets are:

- **the number of rotations** or the rotation coefficient which is an indicator that can be determined on each asset and shows whenever the assets go through all stages of the economic circuit in a period of time; it is determined as the ratio between the turnover and the current assets, and its growth means accelerating the speed of rotation;
- **the duration in days of a rotation** (360, 180, 90 or 30 days) is the indicator for the number of days required by current assets to browse the economic circuit; the product is determined as the ratio of current assets and the time and the turnover, and its level reduction means accelerating the speed of rotation.
- **durata în zile a unei rotații** (360, 180, 90 sau 30 zile) este indicatorul care exprimă numărul de zile necesare parcurgerii de către activele circulante a circuitului economic; se determină ca raport între produsul dintre activele circulante și perioada de timp, și cifra de afaceri, iar reducerea nivelului acestui indicator înseamnă accelerarea vitezei de rotație.

The analysis of these indicators aimed at characterizing the speed of rotation check the acceleration factors (slowdown) both whole and in terms of the structure of current assets for the three stages of the economic circuit as well as for each separate element of current assets. The speed of rotation of current assets influences the most important performance indicators of the company. Accelerating the speed of rotation determines a positive development of these indicators and the slowdown has negative effects. Accelerating the speed of rotation is expressed by increasing the number of rotations for a while or by reducing the duration of a rotation which entails the reduction of current assets at a turnover of 1,000 lei. [4]

## 2.2. Indicators of profitability using current assets

As it is known, the profitability is a synthetic form of expressing the economic efficiency, through which it is reflected the ability of firms to get profit. Thus, the profitability of current assets reflects their

efficiency in terms of profit.

The main indicators are:

- **the profitability rate of current assets** - is determined as the ratio of gross profit (GP) or net profit (NP) and current assets (Ca):

$$R_c = \frac{GP \text{ sau } NP}{Ca} \cdot 100 \quad (1)$$

If in the case of the rotation of current assets is determined how many lei are obtained after sailing 1 leu of current assets, the profitability of current assets shows how many lei brings one leu invested in current assets.

- **the profitability of current assets rotation** - is determined as the ratio of gross profit (GP) or net profit (NP) and the number of turns (Nt):

$$R_{Nt} = \frac{GP \text{ sau } NP}{Nt} \quad (2)$$

The first indicator expresses the volume in percentage of current assets, and the second, the amount of the final results on a circuit.

## 2.3. Intensity indicators of using current assets

It expresses the relationship between the workload and the volume of current assets used and can be determined using the following relations:

- **current assets for 1,000 lei turnover**, indicator which helps to evaluate the speed of rotation of current assets. It is determined as the ratio of current assets and turnover:

$$Ca^{1000T} = \frac{Ca}{T} \cdot 1000 \quad (3)$$

- **current assets of 1,000 lei production**, indicator which helps to evaluate the speed of rotation of current assets depending on the production year; it is determined as the ratio between current assets and production year (P):

$$Ca^{1000P} = \frac{Ca}{P} \cdot 1000 \quad (4)$$

## 3. The methodology for analysing the indicators of current assets to SC OMV Petrom S.A.

Starting from the above mentioned methodology, the data needed to exemplify

all this at SC OMV Petrom S.A. are presented in the table below:

*Table 1* *Million lei*

Nr. crt.	Indicator	2014	2013	2012
1.	Turnover	16.511,64	18.071,91	19.510,05
2.	Current assests	6.549,91	5.284,28	5.587,99

Source: <http://www.bvb.ro/FinancialInstruments/Details/FinancialInstrumentsDetails.aspx?s=SNP>

To highlight the speed of rotation of circulating assets we will calculate the average number of rotations and the average duration in days of a rotation.

$$Nt_{2014} = \frac{T}{Ca} = \frac{16.511,64}{6.549,91} = 2,5209 \text{ rotation} \quad (5)$$

$$Nt_{2013} = \frac{T}{Ca} = \frac{18.071,91}{5.284,28} = 3,4199 \text{ rotation} \quad (6)$$

$$Nt_{2012} = \frac{T}{Ca} = \frac{19.510,05}{5.587,99} = 3,4914 \text{ rotation} \quad (7)$$

The above results show that the current assets turned 2.52 times in 2014, 3.42 times in 2013 and 3.49 times in 2012. The above results can be represented as follows:

*Figure 1 Evolution of turnover, current assests and number of rotations*

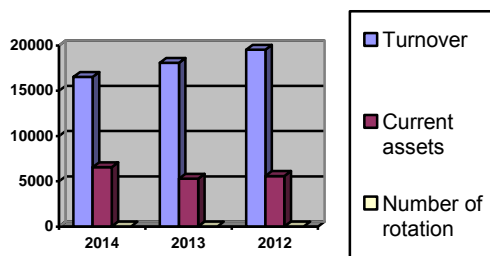

Source: Own data analysis

From the calculations and the graphic representation the indicators involved in determining the number of rotations of current assets it could be seen that the number of rotations of current assets decreased continuously during the three years of study.

The speed of rotation in days (Rday) can be determined as follows:

$$Rd_{2014} = \frac{T}{Nt} = \frac{360}{2,5209} = 142,81 \text{ days} \quad (8)$$

$$Rd_{2013} = \frac{T}{Nt} = \frac{360}{3,4199} = 105,27 \text{ days} \quad (9)$$

$$Rd_{2012} = \frac{T}{Nt} = \frac{360}{3,4914} = 103,11 \text{ days} \quad (10)$$

It may be noticed that in 2014 the speed of rotation in days increased both in 2013 and 2012. Thus:

$$Rdays_{2014} > Rdays_{2013} \Rightarrow 142,81 > 105,27 \quad (11)$$

$$Rdays_{2013} > Rdays_{2012} \Rightarrow 105,27 > 103,11 \quad (12)$$

From the above relationships, it results a slow in the speed of rotation of current assets and the increase of the number of days for a rotation.

This as an expression of the efficiency of current assets can speed up or slow down under the influence of the two factors mentioned above, namely: the turnover and the current assets.

The speed of rotation variation from one year to another as well as the influence of the two factors of variation can be determined as follows.

Speed of rotation deviation in 2014 comparing to 2013:

$$\Delta Rdays = Rdays_{2014} - Rdays_{2013} = 142,81 - 105,27 = +37,54 \text{ days} \quad (13)$$

Influence of factors:

- influence of turnover modification on the variation of rotational speed:

$$\begin{aligned} \Delta_{Rday}^T &= \left( \frac{Ca_{2013} \cdot Time}{T_{2014}} \right) - \left( \frac{Ca_{2013} \cdot Time}{T_{2013}} \right) = \\ &= \left( \frac{5.284,28 \cdot 360}{16.511,64} \right) - \left( \frac{5.284,28 \cdot 360}{18.071,91} \right) = \\ &= 115,2121 - 105,2651 = +9,95 \text{ days} \end{aligned} \quad (14)$$

- influence of modifying current assets on the variation of rotational speed:

$$\begin{aligned} \Delta_{Rd}^{Ca} &= \left( \frac{Ca_{2014} \cdot Time}{T_{2014}} \right) - \left( \frac{Ca_{2013} \cdot Time}{T_{2014}} \right) = \\ &= \left( \frac{6.549,91 \cdot 360}{16.511,64} \right) - \left( \frac{5.284,28 \cdot 360}{16.511,64} \right) = \\ &= 142,8064 - 115,2121 = +27,59 \text{ days} \end{aligned} \quad (15)$$

From the calculations it could be seen that both the variation in turnover and the variation in current assets led to a slowdown in the rate of rotation namely the turnover with 9.95 days and the current assets with 27.59 days.

The direct effect of these variations in current assets and rotational speed can be a release of capital in the case of acceleration or an intangible capital in the case of a slowdown. The calculation formula is: [5]

$$E(\hat{I}) = (Rdays_{2014} - Rdays_{2013}) \cdot \frac{T_{2014}}{Time} =$$

$$= (143 - 105) \cdot \frac{16.511,64}{360} =$$

$$= 38 \cdot 45,87 = 1.742,89 \text{ million lei}$$

Slowing the rotation speed of current assets or increasing the days for a rotation of 38 days, lead to the "blocking" of the capital of 1742.89 million lei.

$$E(\hat{I}) = (Rdays_{2013} - Rdays_{2012}) \cdot \frac{T_{2013}}{Time} =$$

$$= (105 - 103) \cdot \frac{18.071,91}{360} =$$

$$= 2 \cdot 50,20 = 100,40 \text{ million lei}$$

Slowing the rotation speed of current assets or increasing the days for a rotation of 2 days, lead to the "blocking" of the capital of 100,40 million lei.

Determining the profitability indicators by using the current assets at the analyzed company, we will use the following data:

Table 2 Million lei

Nr. crt.	Indicator	2014	2013	2012
1.	Current assests	6.549,91	5.284,28	5.587,99
2.	Gross profit	2.542,96	5.667,09	4.583,47
3.	Net profit	1.837,15	4.839,33	3.850,62

Source: <http://www.bvb.ro/FinancialInstruments/Details/FinancialInstrumentsDetails.aspx?s=SNP>

Based on these data, we calculate the two indicators that highlight the profitability of current assets and of the current assets rotation.

**Rate of current assets profitability:**

$$R_{Ca2014} = \frac{GP}{Ca} \cdot 100 = \frac{2.542,96}{6.549,91} \cdot 100 = 38,82\% \quad (18)$$

$$R_{Ca2013} = \frac{GP}{Ca} \cdot 100 = \frac{5.667,09}{5.284,28} \cdot 100 = 107,24\% \quad (19)$$

$$R_{Ca2012} = \frac{GP}{Ca} \cdot 100 = \frac{4.583,47}{5.587,99} \cdot 100 = 82,02\% \quad (20)$$

or

$$R_{Ca2014} = \frac{NP}{Ca} \cdot 100 = \frac{1.837,15}{6.549,91} \cdot 100 = 28,05\% \quad (21)$$

$$R_{Ca2013} = \frac{NP}{Ca} \cdot 100 = \frac{4.839,33}{5.284,28} \cdot 100 = 91,58\% \quad (22)$$

$$R_{Ca2012} = \frac{NP}{Ca} \cdot 100 = \frac{3.850,62}{5.587,99} \cdot 100 = 68,91\% \quad (23)$$

The date can be graphically represented

Figure 2 Evolution of profitability rate of current assests depending on gross and net profit

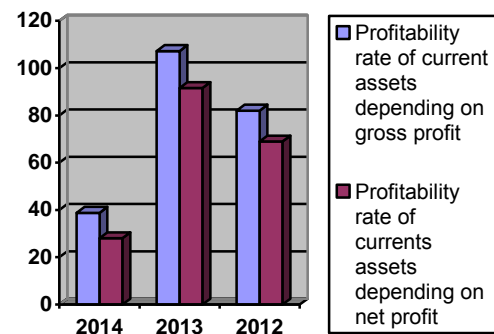

Source: Own date analysis

It is noted that the profitability of current assets both depending on the gross and net profit decreasead substantially in 2014 comparing to 2013 and 2012.

**The profitability of current assets rotation**

$$P_{Ca2014} = \frac{GP}{Nr} = \frac{2.542,96}{2,5209} = 1008,75 \text{ million lei} \quad (24)$$

$$P_{Ca2013} = \frac{GP}{Nr} = \frac{5.667,09}{3,4199} = 1.657,09 \text{ million lei} \quad (25)$$

$$P_{Ca2012} = \frac{GP}{Nr} = \frac{4.583,47}{3,4914} = 1.312,79 \text{ million lei} \quad (26)$$

or

$$P_{Ca2014} = \frac{NP}{Nr} = \frac{1.837,15}{2,5209} = 728,77 \text{ million lei} \quad (27)$$

$$P_{Ca2013} = \frac{NP}{Nr} = \frac{4.839,33}{3,4199} = 1.415,05 \text{ million lei} \quad (28)$$

$$P_{Ca2012} = \frac{NP}{Nr} = \frac{3.850,62}{3,4914} = 1.102,88 \text{ million lei} \quad (29)$$

Briefly, the indicators used in analysing the performance of current assets use it is represented as follows:

Table 3 Value of current assests indicators

Nr. crt.	Indicator	2014	2013	2012
1.	No of rotations	2,52	3,42	3,49
2.	Speed of rotation (days)	143	105	103
3.	Profitability ratio of current assests depending	38,82	107,24	82,02

	on gross profit (%)			
4.	Profitability ratio of current assets depending on net profit (%)	28,05	91,58	68,91
5.	Profitability ratio of current assets depending on gross profit (lei)	1.008,75	1.657,09	1.312,79
6.	Profitability ratio of current assets depending on net profit (lei)	728,77	1.415,05	1.102,88

Source: Data from own calculations

#### 4. Conclusions

Considering the issues outlined above, we can conclude that in assessing the synthetic performance of current assets performance, number of indicators can be used whose values are obtained from the information provided by the financial statements of the company and the obtained results highlight developments related to current assets and the possibility of forecasts.

As an important part of economic activity, the current assets are characterized by their permanent transformation and their consumption in a cycle of exploitation. They also emphasize structural changes produced in determining the objectives relating to the performance of their use.

During the entire analyzed period, the current assets of OMV Petrom decreased in 2013 compared to 2012 (-303,71 lei), and in 2014 increased compared to 2013 (1265,63) and compared to 2012 (961,92). Comparing the turnover which decreased from 2012 to 2014 in current assets, we will get the number of rotations which decreased from 2012 to 2014 and the rotational speed increased from 2012 to 2014.

In practice it is considered that the management of current assets is effective if the duration of rotation of current assets decreases and the number of turns in the

reviewed period increase. [2]

In these circumstances, it is said that the rotational speed of current assets is accelerating. In the case of OMV Petrom, the rotational speed of current assets slowed during 2012-2014 recording a reduction in the number of rotations and an increase in the number of days of a rotation.

Rates of return registered the highest values in 2013, followed by the values in 2012 and then in 2014, the year in which they registered the lowest values.

#### 5. Bibliografie

- [1] Andronic, B.C., *Performanța firmei*, Editura Polirom, Iași, 2000.
- [2] Hristea, A.M., *Analiza economică și financiară a activității întreprinderii*, vol.1, Editura Economică, București, 2015.
- [3] Păvăloaia, W., Păvăloaia, D., *Analiza economico-financiară*, Editura Tehno-press, Iași, 2009.
- [4] \*\*\* <http://www.contabilsef.md>
- [5] Robu, V., Anghel, I., Șerban, E.C., *Analiza economico-financiară a firmei*, Editura Economică, București, 2014.
- [6] Achim, M. V., *Analiză economico-financiară*, Editura Roprint, Cluj-Napoca, 2010.
- [7] Hristea, A.M., *Analiza economică și financiară a activității întreprinderii*, vol.2, Editura Economică, București, 2015.
- [8] Petrescu, S., *Analiză financiară aprofundată. Concepte. Metode. Studii de caz*, Iași, 2005.
- [9] \*\*\* [www.mfinante.ro](http://www.mfinante.ro)
- [10] \*\*\* <http://www.oeconomica.uab.ro/upload/lucrari/820062/35.pdf>

## Do Fiscal Constraints Actually Work in the EU?

Florin-Alexandru Macsim  
"Alexandru Ioan Cuza" University of Iasi  
[florin.macsim1@yahoo.ro](mailto:florin.macsim1@yahoo.ro)

Florin Oprea  
„Alexandru Ioan Cuza” University of Iasi  
[foprea@uaic.ro](mailto:foprea@uaic.ro)

### Abstract

*In the current troubled times for the European economies, the role of numerical fiscal rules as fiscal constraints gets more and more attention, both in scientific research and in public debate. In this regard, it was our objective to analyze the impact of the balance budget rule and its coverage degree on public debt and deficit levels in EU countries.*

*Through our conducted analyses we observed that although a stronger rule conducts to an increase in government's debt levels, a higher degree of coverage of the rule conducts to a strong reduction in debt levels.*

*On the other hand, a stronger rule has a positive impact on deficit levels, although a higher degree of coverage has a strong negative impact.*

*Considering our main findings, we submit to the general point of view that constructing and imposing numerical rules as fiscal constraints is one of the most difficult tasks of policy-makers these days.*

**Key words:** fiscal rules, public debt, public deficits, institutions

**J.E.L. classification:** H30, E61, H63

### 1. Introduction

The current crisis has proved to economists and policy-makers that the role of fiscal rules as fiscal constraints is one not to be neglected. While most EU countries are still trying to recover from the recent economic crisis, it is the duty of EU leaders to ensure a growth path and enhance the positive role of public finances in order to the soundness of their economies. [1]

In this landscape, more and more effort needs to be focused on the role and the impact of fiscal rules, as they can have a huge contribution to the future soundness of public finances and to the economic and financial stability of a country.

By using data provided by the European Commission, we took the task of analyzing the impact of the balance budget rule and its degree of coverage on key aspects of fiscal policies and public finance soundness as governments consolidated debt and public deficits, focusing our analyses on the 28 members of the EU.

Our results indicate that things aren't as quite as they should be, mainly contradictory. First, our results show that the strength of the rule measured thorough the fiscal rule strength index (FRI) influences in a negative way the government consolidated debt, but in positive way the public deficits. Second, our analysis indicates that while a higher coverage degree of this rule conducts to a strong reduction in debt levels, it also conducts to a strong increase in deficit levels.

According to Sachi and Salotti, when strict fiscal rules are introduced, discretionary policy becomes output – stabilizing, results being easier to obtain by using rules focused on maintain balanced budgets, than using rules focused on expenditure, revenues or debt levels. [2] Their findings can be sustained by Albuquerque's earlier results [3], so in this regard according to the literature, imposing rules that target balanced budgets is the best option, although our findings offer a partial support for this statement.

We organized our paper as follows. Section 1 marks our introduction. Section 2 marks our literature review and develops our key hypotheses. Section 3 describes the data sources and the variables used in our



analysis. Section 4 discusses the methods used in our analysis. Section 5 marks our empirical results, while in the last section we present our key findings and conclusions.

## 2. Literature review

The continuing economic turbulence in the EU has drawn more and more attention from politicians, economists and researchers. Despite the repeatedly raised concerns over the lack of fiscal adjustment mechanisms in EMU, most of the attention from the debut of the crisis has been paid to macroeconomic aspects such as fiscal arrangements in monetary unions, such as the Eurozone. [4] While it is quite natural for economists to focus on fiscal rules, it is considered that the need for explicit rules may be explained by the non-benevolent behavior of politicians.

According to J. von Hagen, two sets of rules are generally considered when talking about the crafting of budgets and fiscal policies: numerical targets, including also procedural rules. [5] Our focus in this paper will be oriented to the first category of rules, as through our empirical analysis we will study the impact of the balanced budget rule and its coverage degree over public debt and deficit levels in the EU as study sample. Same author mentions that numerical targets for the budgets may take different forms, with balanced budget constraints being the most stringent type, although the discussion over their optimality being far from over. [5] If effectively enforced, these rules should lead to more fiscal discipline, but our results indicate that this isn't always the case. Moreover, these rules as numerical targets can generate incentives for the use of creative accounting, as shown in literature. [6] Introducing more rules, mainly through treaties, conduces to the use of creative accounting especially when fiscal rules become binding.

The design of institutional constraints on fiscal policy makers, such as the Stability and Growth Pact for example, must be based on an assessment of the problems that constraints are supposed to solve. [7] If these constraints, encourage creative accounting or have a negative impact on the soundness of public finances, then fiscal rules designers should go back to drawing board. Also, we mention that there exists a conflict between

designing rules that discourage deficit bias and rules that encourage optimal policies.

Regarding fiscal rules in a monetary union, A. Ferrero addresses the design of the appropriate rules that a benevolent centralized policymaker would assign to the national fiscal authorities and to the common central bank (in the case of EMU – ECB) in order to deal with the existence of aggregate and idiosyncratic shocks. [8] By focusing on the stabilization properties of alternative monetary and fiscal rules, the author concludes that moving from balanced budget rules to optimal flexible debt targeting improves welfare by more than 50%. But, as Portes and Wren-Lewis pointed, fiscal rules should relate to deficits rather than debt. [9]

Other authors such as Kumhof and Laxton, focused their attention to rule-based countercyclical fiscal policies in small economies. [10] Through their paper, they tried to answer questions such as which of the many feasible fiscal instruments should be chosen to obtain the maximum welfare gain. Their results confirm that optimized simple fiscal rules perform almost as well in welfare gains as the theoretically optimal policies. So, as we have seen so far, fiscal rules lead to gains in welfare numbers.

Regarding the impact of fiscal rules on economic stability, there seems that the impact is also a positive one in this regard. Empirical results found in the literature suggest that there is a correlation between strict rules and stability preferences, countries benefiting more from stricter fiscal rules. But, according to some authors, countries found it difficult to establish strict rules in "normal times". [11] Collective rules of fiscal discipline have proven difficult to fully enforce, although fiscal policies have to comply with agreed rules. In this regard, Buti and Carnot state that the original mix of fiscal rules and market discipline do not suffice to ensure sound fiscal policies across all EMU members. [12] In addition, according to some authors, even a country that follows a responsible fiscal rule can experience fiscal solvency crisis. [13]

### *Hypotheses:*

1. A stronger balanced budget rule and a higher degree of coverage leads to lower public debt levels;
2. A stronger balanced budget rule and a higher degree of coverage leads to smaller

levels of the public deficits;

3. A higher number of fiscal institutions leads to better coverage and control of fiscal and budgetary policies, thus conducts to lower debt and deficit levels.

### 3. Data and preliminary results

We used in our analysis data composed of the fiscal rule strength index and macroeconomic variables specific for the 28 members of the EU, the sample period being 1995-2013 (annual records). We used dummy variables such as member of the EU (1), nonmember of the EU (0), member of EMU (1), nonmember of EMU (0), period of crisis (1 for the years 2008-2011 – 0 otherwise).

As independent variables we used the

Balanced Budget Rule Strength Index (BBRCGG), its coverage degree (CovBBRCGG) calculated and provided by the European Commission and the number of fiscal institutions that supervise budgeting.

As dependent variables we used the Governments Consolidated Debt as percentage of the GDP (GCDGDP) and the public debt as percentage of the GDP (PDGDP) provided by Eurostat. Our chosen control variables were logarithm of GDP per capita (GDPCAPL), the growth rate of the GDP (GRGDP), the growth rate of the government's expenditures as percentage of the GDP (GREGDP) and the growth rate of governments revenues as percentage of the GDP (GRRGDP).

Table 1. Preliminary analysis on the correlations between our key variables

		BBRCGG	CovBBRCGG	GCDGDP	PDGDP
BBRCGG	Pearson Correlation Sig. (2-tailed)	1 160			
ERCGG	Pearson Correlation Sig. (2-tailed)	.123 .128	1		
GCDGDP	Pearson Correlation Sig. (2-tailed)	.243** .003	-.138* .000	1	
PDGDP	Pearson Correlation Sig. (2-tailed)	-.189* .017	.065 .419	-.335** .000	1

\*\* . Correlation is significant at the 0.01 level (2-tailed).

(Source: Author calculations)

Table 1 depicts our initial investigation into the links between our independent and dependent variables. The results indicate that there is a relatively strong connection between the strength of the rule and the governments consolidated debt, while the connection between the degree of coverage and the governments consolidated debt is a negative and weaker one. There seems to be no correlation between the public deficit and the coverage degree of the rule. Also, our initial results indicate that there is a negative correlation between the governments consolidated debt and the public deficits.

### 4. Methodology

In order to establish the relationship between the budget balance rule strength

index, coverage of degree of the rule, supervising institutions and fiscal policies, we employ the next basic model (1):

$$\begin{aligned} & \text{Government debt indicators}_{c,t} \\ & = \alpha_i + \beta_1 \text{Fiscal rules indicators} + \\ & \beta_2 EU_{c,t} + \beta_3 UEM_{c,t} + \beta_4 POC_t + \beta_5 N_{c,t} \\ & + \varepsilon_{i,t} \quad (1) \end{aligned}$$

Where:

- *Government debt indicators*<sub>c,t</sub> is one of the two indicators we used: governments consolidated debt and public deficits levels;

- *Fiscal rules indicators* is one of the three independent variables that we used: Budget Balance Rule Strength Index, Coverage of the Budget Balance Rule and the Number of Institutions;

- *EU*<sub>c,t</sub> depicts the European Union accession dummy by year;

- *UEM*<sub>c,t</sub> is the European Monetary Union

accession dummy by year;

- $POC_t$  is a dummy variable, depicting the 2008-2011 economic crisis;
- $N_{c,t}$  represents depicts our choosen country specific control variables;
- $\varepsilon_{i,t}$  is the standard error.

In order to capture the influence of the fiscal rules indicators we used Ordinary Least Squares panel distribution with fixed effects, in order to allow for country specific characteristics as governments spending and revenues to be accounted. While the budget balance rule strength index and its coverage degree were calculated and provided by the European Commission according to a specific algorithm, the number of institutions that supervise and control budgeting was calculated by us using the independent fiscal institutions database provided also by the European Commission. In all our models, all

specific control indicators are lagged +1 year, mainly because all the calculated growth rates exert a direct influence on the budgetary process for the next fiscal year. In order to circumvent the risk if serial correlated errors, we have conduct our analysis with all standard errors clustered at a country level.

## 5. Empirical Results

In order to test our hypotheses we used the previous mentioned model. In the second model we introduced into our analysis the dummy variable POC (period of crisis), in order to view if our results record significant changes, especially because by taking a look in our database we observed that some values are often provided for the crisis period and years after.

Table 2. Governments Consolidated Debt, Public Deficits and influencing variables

	Panel A: Dependent variable GCDGDP		Panel B: Dependent variable PDGDP	
	Model 1	Model 2	Model 1	Model 2
BBRCGG	8.850* (4.194)	8.856* (4.284)	-1.314* (0.666)	-1.350 (0.907)
CovBBRCGG	-171.751** (62.66)	-171.350* (61.576)	34.975*** (9.088)	32.938*** (10.536)
NOI	18.176* (8.360)	18.123* (18.123)	-1.117* (0.616)	-0.829 (0.730)
MEU	3.943 (3.012)	3.959 (2.958)	0.213 (0.680)	0.146 (0.704)
MEMU	9.038*** (2.980)	9.033*** (3.025)	0.289 (0.777)	0.329 (0.661)
GDPCAPL	-18.659 (12.163)	-18.909 (11.485)	-0.839 (1.807)	0.417 (1.742)
GRGDP	-0.487 (0.304)	-0.490 (0.311)	0.081 (0.051)	0.096 (0.058)
GREGDP	0.203 (0.135)	0.195* (0.100)	-0.250*** (0.036)	-0.212*** (0.029)
GRRGDP	-0.060 (0.112)	-0.056 (0.095)	0.310*** (0.067)	0.284*** (0.052)
POC		0.254 (2.740)		-1.344* (0.702)
Number of observations	137	137	140	140
R squared	0.190	0.198	0.015	0.020
F-Stat	9.01	261.63	36.20	106.33
(p-value)	0.000	0.000	0.000	0.000

First row is beta coefficient. Second row is the standard errors clustered at country level. \*\*\* denotes significant at 1%, \*\* at 5%. And \* at 10%.

(Source: Author calculations)

By looking at our results for Panel A, we can easily notice the fact that our first hypothesis was only partial confirmed. First, our results indicate that a stronger balance

budget rule conducts to an increase in governments consolidated debt levels. Second, we obtained surprising results regarding the influence that the degree of

coverage of the rule has on governmental debt levels. According to resulted values, a higher degree of coverage conducts to a high decrease in debt levels, fact confirmed by both models. Therefore, in maintain sound public finances, is more important the coverage degree of the rule than the rule itself in almost all given situations. Unfortunately, as we have discussed in another paper, an increase in the number of institutions conducts to an increase of the public debt, as a result of a weaker degree of independence of institutions or due to a dispersion of duties among a higher number of authorities. But, Panel B, Model 1 results indicate that a higher number of institutions may lead to a small decrease of the public deficits, so our third hypothesis is also partially confirmed. Also, our results strongly indicate that the accession to EMU of a EU member state conducts to an increase in debt levels as well.

On the other hand, neither our second hypothesis isn't fully confirmed, giving the fact that our results strongly indicate that a higher degree of coverage of the balance budget rule conducts to increasing public deficits levels. Only Panel B, Model 1, indicates that a stronger rule may conduct to reductions in governmental deficits levels.

## 6. Conclusions

Our analysis was mainly focused on the correlations between our key dependent and independent variables and on the influence that independent variables have on dependent variables.

We consider our results to be at least controversial. While a stronger rule conducts to an increase in the governments debt levels, it also conducts to a reduction in deficit levels. Also, according to our analysis, while a higher degree of coverage influences in a positive way governments consolidated debt levels, conducting to decreases, it also influences in a negative way the central budget through increases in deficit levels.

Neither having more supervising institutions doesn't help in maintaining sound public finances, Panel A results indicating that a higher number of institutions conducts to increases in debt levels. Contrary, Panel B Model 1 results indicate a positive impact, a higher number of institutions conducting to

smaller public deficits.

So, it seems that developing and implementing fiscal rules as fiscal constraints in order to maintain the soundness of public finances is a hard task to complete successfully, even in an already formed monetary union such as the European Monetary Union that is taking steps in forming a fiscal union in the future. Giving the fact that the data provided by the European Commission regarding the strength of the debt rule and its coverage degree was mostly missing, we were unable to include in our analysis these two variables as independent variables. Also, because of missing data, we were unable to use the expenditure rule or the revenue rule.

Also, as limitations for our study, we mention that for some years for specific countries data was unavailable. While more data will be provided by the European Commission, we consider repeating the analysis in the future.

## 7. Acknowledgements

Funding for this work was provided by the European Social Fund through the Sectoral Operational Programme Human Resources Development 2007-2013, project number POSDRU/187/1.5/S/155656 "Support for PhD Students in economics science domain".

## 8. References

- [1] Bilan, I., "Mechanisms limiting public debt's proportions and their applicability in the European Monetary Union member states". *Annals of "Tibiscus" University of Timisoara*, 2009, Vol. 15, 141-148
- [2] Sacchi, A., Salotti, S., "The impact of national fiscal rules on the stabilization function of fiscal policy", *European Journal of Political Economy*, 2015, Vol. 37, 1-37
- [3] Albuquerque, B., "Fiscal institutions and public spending volatility in Europe", *Economic Modelling*, 2011, Vol. 28, 2544-2599
- [4] Evrs, M., "Federal fiscal transfer rules in monetary unions", *European Economic review*, 2012, Vol. 56, 507-525
- [5] Eslava, M., "The political economy of fiscal deficits: a survey", *Journal of Economic Surveys*, 2011, Vol. 25, 645-673
- [6] von Hagen, J., Wolff, G.B., "What do deficits tell us about debt? Empirical evidences on

- creative accounting with fiscal rules in the EU", *Journal of Banking & Finance*, 2006, Vol. 30, 3259-3279
- [7] Lindbeck, A., Niepelt, D., "The Stability Pact – Rationales, Problems, Alternatives", *Blackweel Publishing Ltd.*, Oxford, 2006, 579-600
- [8] Ferrero, A., "Fiscal and monetary rules for a currency union", *Journal of international Economics*, 2009, Vol. 77, 1-10
- [9] Portes, J., Wren-Lewis, S., "Issues in the design of fiscal policy rules", *The Manchester School*, 2015, Vol. 83, 56-86
- [10] Kumhof, M., "Simple fiscal policy rules for small open economies", *Journal of International Economics*, 2013, Vol. 91, 113-127
- [11] Heinemann, F., Osterloh, S., Kalb, A., "Sovereign risk premia: The link between fiscal rules and stability culture", *Journal of International Money and Finance*, 2014, Vol. 41, 110-127
- [12] Buti, M., Carnot, N., "The EMU Debt Crisis: Early Lessons and Reforms", *Journal of Common Market Studies*, 2012, Vol. 50, 899-911
- [13] Daniel, B.C., Shiamptanis, C., "Pushing the limit? Fiscal policy in the European Monetary Union", *Journal of Economics Dynamics & Control*, 2013, Vol. 37, 2307-2321

# Preoccupations and Tendencies within the Romanian Accounting Space Regarding the Capitalization of Intangible, Incorporate Assets Owned by Companies in the International Context of Integrated Reporting

Marinela – Daniela Manea

Valahia University of Târgoviște, Faculty of Economics

[m\\_manea7@yahoo.com](mailto:m_manea7@yahoo.com)

## Abstract

*In the light of recent UE regulations regarding non-financial<sup>1</sup> reporting, according to which large companies that have more than 500 employees will be forced to publish relevant info about environmental and social issues in the annual reports, the current paper aims to capture the concern of the autochthonous organizations to capitalize their incorporeal intellectual potential, which is a component of the intellectual capital, an essential item of integrated reporting. The sample comprises Romanian companies that have been listed on the Bucharest Stock Exchange, with the research aiming to test two measurement indicators for intangible assets: Market to Book Value and Tobin's Q ratio.*

**Key words:** integrated reporting, non-financial information, intellectual potential, capital.

**J.E.L. classification:** M41

## 1. Introduction

Scientific literature considers that Integrated Reporting is a set of processes and activities that have the visible and concise result of a periodic reporting regarding the way in which the strategy, management, performance and the predictions of the organization allow the creation and maintenance of value on long term<sup>2</sup>. The present reports offered by the traditional accounting system have become insufficient

to reflect the clear and complete picture of the organization's impact on the environment and the community where it conducts its activity, therefore new methods are needed to help fill in the information offered by accounting regarding the social and environmental issues. The differences between the present and the integrated reporting methods, according to their features, can be seen from the chart below:

Chart nr. 1 "Differences between the present and integrated reporting"

Characteristic	Present reporting	Integrated reporting
Trust	Limited disclosure	Increased transparency
Management	Financial	All capitals
Approach (Reflection)	Isolated	Integral
Focus	Past; Financial	Past and future; Connection, strategy
Timeframe	Short term	Short term, medium term, long term
Adaptability	Restricted to regulations	Replies ro individual requirements
Concision	Long and complex	Concise and significant
Technology		Using technology

Source: <http://www.kpmg.com/Global/en/IssuesAndInsights/ArticlesPublications/Documents/road-to-integrated-reporting.pdf>, p. 3

Taking into account the strong differences mentioned above, the objectives of the integrated reporting are:

✓bringing changes to the organizational behavior in order to take decisions that are aimed towards creating and maintaining the value on short term, medium term and long term;

<sup>1</sup> The European Parliament approved the Directive No. 2014/95/UE in 15 April 2014, while the European Council in September 2014

<sup>2</sup> IIRC - Prototype Framework - Working draft, p.47

✓thorough information about the allocated resources by the investors, which should sustain the creation and maintenance of the value on short term, medium term and long term;

✓inducing a unitary and comprehensive approach for corporate reporting that will lead to the communication of the entire chain of factors that significantly affect an organization's ability to create and maintain value in time;

✓promoting responsibility and optimum utilization of all the organization's capitals (including the production, human, intellectual, natural and social capital), not only the financial capital, as well as understanding the interdependencies.

The conceptual approach of Integrated Reporting (Botez D., 2013) is based on three essential elements: capital, business model and the process of creating and maintaining the value. Why is capital important? All organizations depend on a large variety of capital forms in order to ensure their success. These capitals stand for entries into the business model of the organization and they also stand for exits, since they are transformed, consumed, increased and used (depleted), modified or other methods that affect all the activities of the organization of creating added value.

The sum of the capital resources is not fix over time. There is constant movement between and within the capitals, which increase, decrease and transform. The way in which organizations increase or decrease capitals has an important effect regarding the access (availability), the quality and capacity to acquire them, especially concerning those which are limited and nonrenewable. This aspect can affect the long term sustainability of a business model for businesses and, as a consequence, it can affect the ability to create and preserve value in time.

An organization usually uses six types of capital. The capitals are defined as follows:

Chart nr. 2 "The types of the capital"

1	Financial capital	Financial capital is broadly understood as the pool of funds available to an organization. This includes both debt and equity finance.
2	Manufactured capital	Manufactured capital is seen as human-created, production-oriented equipment and tools.

3	Human capital	People's skills and experience, and their capacity and motivations to innovate
4	Intellectual capital	Intangibles that provide competitive advantage, including: a) intellectual property (such as patents, copyrights, etc) b) the intangibles that are associated with the brand and reputation that an organization has developed.
5	Natural capital	Natural capital is an input to the production of goods or the provision of services. An organization's activities also impact, positively or negatively, on natural capital.
6	Social and relationship capital	The institutions and relationships established within and between each community, group of stakeholders and other networks to enhance individual and collective well-being

Source: IIRC website

Of course, not all these capitals are equally relevant or applicable in all organizations. The capital gains valence if it is being used in a business which creates value and since the Romanian reality has given insufficient attention to the other types of capitals, excluding the financial one, the current paper sets out to test the ability of the marketable Romanian organizations to invest in the intellectual capital, its immaterial component.

## 2. What is the intellectual capital?

According to scientific literature in the given field [1] intellectual knowledge and capital are the *hidden* assets of a company, which confirms the idea [2] regarding the creation of competitive advantages through a good management for this kind of assets. There have been two schools of thought which have allowed the development of the concept of intellectual capital: one of them is based on *strategy*, the other one on *measurement*. The strategic school is based on the *organization that keeps learning* as well as the relationship between knowledge and the success of creating value. Therefore, conceptual evolutions regarding innovation are capitalized, as well as the management of

knowledge transfer and the key components for the success of strategic approaches. The school related to measurement starts at the management of human resources as well as the techniques of financially measuring the capital, fixing problems connected to the measurement of knowledge held by employees and the company [3]. In order to lead to the development of the concept of intellectual capital, the two schools were correlated and merged at the level of organizations.

In order to clearly define the concept of intellectual capital, the following statements are paramount [4]:

✓ The intellectual capital is the sum between everything that the people within an organization know, offering it competitive advantages on the market;

✓ The intellectual capital stands for knowledge, which is very valuable for organizations;

✓ The intellectual capital is recognized as a value in the majority of organizations, but this is not measured and assessed in any other financial declaration of the organization with the exception of the market value achieved on the stock exchange;

✓ The intellectual capital stands for the intellectual material, which was formalized, seized and put in value in order to produce more valuable assets.

The intellectual capital is given by that knowledge, which can be transformed in value. The intangible character of the new type of capital creates even more problems. Intangibility means that it doesn't show up in any financial or accounting document of the company and it can't be identified through a traditional physical form. The creation and management of the intangible assets which comprise the intellectual capital needs different approaches than the conventional business strategies. A requirement for the systematic development of the intangible assets is for these to be easily identified, classified and reported. The vast majority of the classifications of the intangible assets describe them as a difference between the market value and the accounting value of the company.

### 3. Research methodology

Empirical studies in the field [5], [6] have highlighted significant differences between the market value of a company and the net accounting value. The explanation consists in the presence of the intangible assets in the wealth of an organization; thus, after the 2000s, significant efforts were allotted to the identification and quantification of the *lacking assets*. In 2004, the statistics showed that Microsoft's market value was \$286.2 billion, while the accounting value only reached \$57.3 billion, pointing towards a 5:1 ration in favor of intangible resources. Likewise, eBay's market value was \$54.5 billion, while the accounting value was only \$4.9 billion, which comes to an 11:1 ratio for immaterial assets [7]. Other published data showed an annual profitability level of net assets of 52% in the case of Glaxo, therefore a recovery in less than two years for the value invested in the net assets. In this context, the market noticed and capitalized the differences between the old industries based on intensive knowledge usage as well as the old *lethargic* products, with a fixed outlook, and the new *smart* products, which are able to interact with the environment and the client.

The evolutions within the economic environment aimed towards the development of knowledge economy were accompanied by attempts to explain the mechanisms which lay at their foundation and to create new concepts, tools and models to allow the companies to understand and react to new challenges [8].

Within this context, the study approach aimed to identify to what extent the Romanian companies listed on the Bucharest Stock Exchange capitalize the potential intangible intellectual of the incorporeal assets which they have in order to maximize performance. Since the Romanian accounting and the professionals in the field are just starting off in the process of quantifying and measuring the intellectual capital, the research focused on companies which admitted in the published financial situations information regarding the intangible assets. Although we initially wanted to carry out an analysis on a single activity domain, the limitation imposed by the decreased number of companies ranked on activity sector, not



recognizing the incorporeal assets within the set of published financial situations, drafting annexes to the financial situations (those which target the fixed assets), which are quite lapidary, the significant restriction of the obtained sample, etc have led to the extension of the analysis on four activity domains, each with its specific. Therefore, two hypothesis were formulated:

✓ Hypothesis nr. 1: Does the assessment method for intangible assets Market to Book Value allow the conclusion that the entities involved in the study capitalize their immaterial potential?

✓ Hypothesis nr. 2: From the process of assessing the intangible assets according to the method Tobin's Q ratio is it confirmed the capitalization of the immaterial intellectual?

The study involves both a qualitative approach as well as a quantitative one based on the empirical data gathered from a sample of 34 companies listed on the Bucharest Stock Exchange. The qualitative research helped us to present and support a few concepts so that we obtained thorough explanations for the researched phenomena and processes. Therefore, the approached topic generates questions to which we tried to answer in a coherent and logical manner, since the objective of the research had its answer in a qualitative research.

The quantitative research is use to measure the Market to Book Value and the Tobin's Q Ration for 2013 year.

#### 4. The sample and the obtained results

In our quest, the objective was to identify those companies which offer a significant importance to the investment in the intellectual capital for the intangible assets; this is why we will focus in the following on the measurement of the intellectual company with the help of Market to Book Value and Tobin's Q ration. In order to do this, in the first step of the process we focused on those companies which acknowledged in the set of annually published situations the intangible elements – components of the intellectual capital, with the above mentioned indicators used as tools for digital evaluation of the potential intellectual.

Although we initially chose 100 companies ranked at the Bucharest Stock

Exchange so as to test the two indicators, as a consequence of an insignificant proportion of the incorporeal assets in the total of the fixed asset owned by the entity (under 1%), the sample was restricted to only 32 companies.

For each organization within the structure of the sample we tested the Market to Book value and Tobin's Q ratio indicators. The first indicator, as a difference between the market value and the net accounting value is easy to model for the listed companies in the sample. The market value is calculated as a product between the price of a share and the total number of shares, and the net accounting value, as it is known, stands for the difference between the total of the assets and the one of the debts. What is left has an intangible nature, with the model being among the few which provide a numerical value to the intellectual capital of intangibles. Tobin's Q ratio makes a comparison between the market value of an asset with its replacement cost, with a ratio of almost 2, pointing towards significant investments of the company in technology and human capital.

The following results were obtained after modeling the two indicators:

*Chart no. 3 The measure of the  $I_1$  and  $I_2$  indicators*

The field	Market to Book Value 2013	Tobin's Q Ration 2013
<i>Shipping and Transport Logistics field</i>		
Aerostar S.A.	55.033.528	1,42
Compania Auto Topoloveni S.A.	-20.371.195	0,22
Elerom S.A.	-9.338123	0,15
Fabrica Scule Râșnov S.A.	-2.592.719	0,89
Remarul S.A.	-87.241.113	0,10
Șantierul Naval Constanța S.A.	-61.388.206	0,24
Turbomecanica S.A.	-20.332.000	0,33
<i>Building Industry</i>		
Cloval S.A.	33.170.919	3,05
El Co S.A.	-17.040.508	0,32
Forma S.A.	1.202.346	1,78
Fortpres Cugir S.A.	82.271.937	10,87
Iamu S.A.	1.953.373	1,06
Lafarge Betoane	47.782.101	-5,59

S.A.		
Mat S.A.	-79.711.665	0,16
Microelectronica S.A.	-1.690.591	0,92
Mușatini S.A.	-249.298	0,62
Navexim S.A.	-418.549	0,65
Petrodesign S.A.	2.407.452	2,76
Premium S.A.	-1.719.470	0,29
Proiect Bucovina S.A.	-3.120.390	0,10
Rosar S.A.	-3.177.256	0,08
Saif -Tim S.A.	1.907.431	1,51
<i>The Production and processing power, natural gas</i>		
Romgaz S.A.	13.091.214.602	1409,75
Transgaz S.A.	-349.343.176	0,89
Transelectrica S.A.	1.923.032.498	729,13
Oil Terminal	-379.980.070	0,13
OMV Petrom	-2.273,49	0,91
<i>Pharmaceutical industry</i>		
Farmaceutica Arcatim S.A.	4.365.351	1,25
Farmaceutica Remedia S.A.	-11.649.860	0,71
Genko Med Group S.A.	54.290.985	2,37
Medimfarm S.A.	-8.344.680	0,22
Meduman S.A.	-7.256.290	0,20
Rompharma S.A.	68.782.794	1,60
Sintofarm S.A.	8.205.928	1,77

## 5. Result interpretation

The results' analysis starts off with the study of the percentage of the incorporeal assets in the total of the intangible assets. With the exception of the entities within the pharmaceutical sector, where the incorporeal assets owned between 10% and 40% of a few other firms like Fabrica Scule Râșnov S.A., Turbomecanica S.A., Rosar S.A., Transgaz S.A., the societies within the other activity sectors don't have within the structure of immobilized assets incorporeal elements that go over 5%. The weak presence of the incorporeal assets within the set of financial situations proves the lack of preoccupation of the Romanian reporting entities in capitalizing their incorporeal potential, which they could own at some point.

Regarding the measurement of the two indicators, we didn't encounter any difficulties, however the results are

contradictory. The positive values of the differences between the market value and the net accounting value, respectively the supra-unitary value for Tobin's Q ratio were registered in the following situations:

✓ within the *Shipping and Transport Logistics* field only S.C. Aerostar S.A validated both indicators;

✓ within the *Building Industry* 6 of the 15 entities (Cloval S.A., Forma S.A., Fortpres Cugir S.A., Iamu S.A., Petrodesign S.A., Saif -Tim S.A.) verify the two suggested hypothesis, realizing positive values, surpassing 0 by a lot with the Market to Book Value indicator, and surpassing 1 with Tobin's Q ratio;

✓ likewise, within the *Production and processing power, natural gas* domain, on two of the five analyzed entities (Romgaz S.A., Transelectrica S.A.), the values of the modeled indicators are reassuring compared to the normal registered within the Romanian area;

✓ within the *Pharmaceutical industry* 4 out of 7 societies Farmaceutica Arcatim S.A., Genko Med Group S.A., Rompharma S.A., Sintofarm S.A.) validated the suggested hypothesis.

Beyond the positive results registered by the above mentioned societies, 62.14% of the companies within every activity sector (85.71% in the transportation sector, 60% in the construction industry as well as in the producing/ manufacturing of energy/gas, 42.86% in the pharmaceutical industry) failed to validate both hypothesis, indicating a weak preoccupation towards the capitalization of immaterial assets.

## 6. Conclusions

At the moment, the Romanian entities are dealing with a challenging business environment, dictated by the increase of the prices for resources and the decrease for request, respectively with an international and European context in which the societies have adopted value-based management. Since the international and European entities follow the lead of the researches in the intangible resources domain and voluntarily offer data about the intellectual capital which they own in order to help those who desire to invest or to discover the performance and the current and future value of an entity,

Romanian entities too should emphasize the value of the intellectual capital. Confronted with the effects of the economic crisis, the Romanian entities were preoccupied by the identification of resources for acquiring liquidation rather than by the measurement and capitalization of the intangibles they own.

## 7. References

- [1], Skyrme, D., (1997), *Measuring the Value of knowledge - Metrics for the Knowledge Based Business*, Business Intelligence, London.
- [2], Stewart, T.A. (1997), *Intellectual Capital - The New Wealth of Organizations*, Doubleday, New York.
- [3], Bahra, N., (2001), *Competitive Knowledge Management*, Palgrave, New York.
- [4], Nica, P., Neșțian, A., (2006), *Concepte și modele de knowledge management aplicabile în dezvoltarea regională*, Cross-Cultural Management Journal, volumul VIII, issue 2 (15)/2006.
- [5], Brennan., N., 2001, „*Reporting intellectual capital in annual reports: evidence from Ireland*”, Accounting, Auditing and Accountability Journal, Vol.10, No. 2, pp. 18-30.
- [6], Gröjter, J.E., Johanson, U., 1998, “*Current development in human resource costing and accounting*”, Accounting, Auditing and Accountability Journal, Vol. 11, No. 7, pp. 14 –21
- [7], Dess, G.G., Lumpkin, G.T., Eisner, A.B., 2006, *Strategic management*, second edition, McGraw-Hill Irwin, Boston, 2006, pp. 119.
- [8], Nonaka, Ikujiro, Hirotaka Takeuchi, (1995), *The Knowledge - Creating Company: How Japanese Companies Create the Dynamics of Innovation*. New York: Oxford University Press.

# The Procedure Of The Joint Stock Company's Capital Increase By Converting The Debts

Gabriel Mihai

*Faculty of Law and Administrative Sciences*

*"Ovidius" University of Constanta*

[gabrielmihaiuniv@yahoo.com](mailto:gabrielmihaiuniv@yahoo.com)

## Abstract

*The conversion of the debts into shares is a very commonly used method in the jurisdictions of the states that are based on a market economy because of its potential to turn an adversarial situation into a collaborative relationship beneficial to both sides . The legal implications of this operation in the Romanian law converge to some risks, but although our legislation is not yet adapted to this practice, we can observe an increase in the concern for the conversion of debts into shares.*

*The method of converting a debt or multiple debts into shares in a joint stock company is a simple and required one necessary for the companies in order not to remain indebted or to avoid a potential insolvency in the case the debt is not met in time.*

**Keywords:** capital, increase, debt, conversion, company, shares

**Classification J.E.L.:** K

## 1. The joint stock notion.

The joint stock company is formed by the full and simultaneous subscription of the capital by the signatories of the articles of incorporation or by public subscription; the paid-up capital at the formation cannot be less than 30 % of the subscribed capital, the difference will be paid within 12 months from the date of registration, in the case of cash contributions, or 2 years for the company's social contributions in kind. The stock capital of the joint stock company or of the limited partnership by shares can not be less than 90,000 lei. According to the art. 10 of the Law no.31 / 1990 , the government

will be able to change at most every two years , the minimum capital, respecting the exchange rates, so that the amount to be the equivalent in RON of 25,000 EUR. [1]

## 2. The contributions paid by the partner's compensation of debts towards the company.

In the case of joint stock companies, the payment of cash contributions is strictly regulated, but subject to this legal framework, in some court decisions was upheld the validity of a compensation to operate supplementary payments made in relation to the shares subscribed during the formation of the company. Disbursement by offsetting is possible only if the shareholder has a cash due debt against the company. Otherwise, the claim must be the subject of a contribution in kind, subject to the formalities of possible ratings.[2]

## 3. The contributions paid by the partner's debts compensation s on a third party other than the company.

During the formation of a company or of a capital increase, the partner cash flows the contribution promised to the company by its lender, co-founder and copartner. The lender of the person who actually paid the amount in question will receive the titles released due to his amount of the payment made by the borrower, though the consensual debt remission during this operation should be valid. (it is preferable to comply with the formalities of the contribution in kind and the debt to be the creditor's contribution).

#### **4. The legal and economic operation of the capital increase.**

The capital of the joint stock company may be increased by the following methods[3]:

- Issuing new shares or increasing the nominal value of the existing shares by making new contributions in cash and / or in kind;
- Increasing the nominal value of the existing one;
- Incorporation of the reserves (excepting the legal ones), the profits or the share premiums;
- The conversion of liquid and due debts over the company with shares from the latter.

#### **5. The capital increase through the conversion of the debt.**

The method of converting a debt or more debts in a joint stock company is a simple and required method for the companies to not become indebted or to avoid a potential insolvency in the case the claim is not met in time.[4]

The compensation of due and liquid debts by the company with shares or equity interests is a way to increase the share capital and consists of transforming the debts that third parties have into shares or equity interests, based on the agreement of the creditor and debtor who, instead of extinguishing the debt, understand, by the objective novation, to transform the payment obligation into the obligation to issue equity interests or shares and distribute them to the lender.[5]

#### **6. The capital increase through the conversion of the debt for the joint stock company.**

The compensation of liquid and receivables debts to the company with shares or equity interests is another way to increase the capital, known as: the Conversion of the company's debts into shares. According to Art.210 paragraph 2 of the Law no. 31/1990 one may acquire shares in exchange for debts. Both the legal nature of the debts viewed for conversion (secured debts, unsecured etc.) and the creditor are

completely irrelevant. (creditors in legal relations with the company or shareholders who lent to the company).

The legal transaction is not, strictly speaking, a compensation (which presupposes the existence of two certain debts, liquid and due and which extinguish both of them, until their competition), but it represents a transformation of the debts that third parties have towards the society in shares or equity interests, based on the agreement of the creditor and debtor, who, rather than extinguish the debt, understand, via objective novation to transform the company's obligation to pay into the company's obligation to issue shares or equity interests with a value equal to or in a certain relation to the debts, that will be distributed to the lender.

The practice has shown that this conversion cannot be achieved if, at the date of conversion, the amounts sent to the company by the shareholders, representing their underlying rights cannot be found in the Company's assets being used by it to pay debts to third parties. The capital increase by compensation the debts against the company with its shares is performed by an accounting transaction of paying some sums of money between the accounts liabilities of the company because, existing a limit to the general pledge of creditors, the capital must be real, so that in the assets of the company must be permanently goods or rights whose value is not lower to the capital, assessed according to the whole patrimonial assets and not only in relation to the sums advanced by the associates.

#### **7. The effects of the capital increase through the conversion of debt.**

The main effect of the capital increase through the conversion of the debt is the relieving of the company from the debts that the shareholders had on it as a result of the fact that the funds are transferred from one liability account to another. Another effect is that with the capital increase the ownership structure is changed, and hence the creditor shareholder has a higher percentage than before the increase which, if the company prospers may mean more reward, via dividends, than the original debt per se.

## **8. The prior procedure to the capital increase by the conversion of the debt.**

Before the joint stock companies' increasing of the capital, according to the law, it is necessary to perform an accounting expertise whose findings must be presented in a report. In the introduction to the accounting expertise report it is identified the CECCAR certified accountant specifically designated by the company to fulfill this function prior to the capital increase. Then, it is specified the objective of the expertise report - the capital increase. Finally, it is presented the manner in which the issued shares will be subscribed to the two creditor companies of the debtor company.

In practice, we may encounter different situations in which we can extinguish a debt, either under a loan contract or if the company that subscribes shares after this expert report uses its prerogative as a shareholder under the law, and in exchange of an amount fully paid shares were issued to extinguish the debt once made through the full payment of money.

In the expert report it is described the actual conduct of the expertise namely the appointed expert examination of the documents made available by the company that called for the report. After examining the documents provided by the company, the expert first presents the current situation of the company, namely the amount of the capital and the shares subscribed to the society and the state of the company after the capital increase concerning the amount of the capital and of the shares subscribed to the company, these findings being absolutely necessary for the approval of the Decision of the Shareholders General Assembly to increase the share capital.

The final part of the accounting expertise report presents the structure of the capital as a result of the increase, being shown the contribution of each partner and the number of shares owned by each partner. The next step in the procedure of the share capital increase is the convening of the Extraordinary General Shareholders meeting that ensures the management of the company, given the fact that the foundation of a joint stock company is the will of the people who associate, gathering their contributions in order to gain profit.

The General Assembly takes place at the company's headquarters and at the office mentioned in the notice, except when, through articles, it is not otherwise ordered. The General Assembly decisions are deliberative and not contractual in nature. [6].

## **9. The General Assembly.**

After achieving quorum, the first action of the General Assembly is the election of the Chairman and the Secretary. The agenda is voted and after its adoption, the debates start and they are recorded, just like the votes, in a report by the Secretary of the General Assembly. The Assembly analyzes all the documents that help make the decision, including the expertise report and afterwards, the voting starts. One share means one vote. After the vote has been validated by the President, the results of the shareholders' votes will be recorded. In practice, it is customary that by decision to empower the person who will sign the amended articles of association and the person who will present the General Assembly decision to the Trade Register to be published in the Official Gazette.

The decision is presented at the Trade Register Office where the company is registered. The documents required for the submission of a decision of the General Assembly to increase the capital at the Trade Register are: the application form; the document modifying the constitutive act; the evidence of the disbursement making of the contributions to the capital; the prior notices according to special laws, a special power or a power of attorney for the persons designated to carry out the legal formalities; the articles of incorporation as amended certified by a lawyer if it contains the statements of the partners and of the administrator; the evidence of judicial stamp duty, the registry fee; the tariff for the publication in the Official Gazette, Part IV.

The capital increase by the compensation of the liquid and due debts by shares is regulated in the Law 31/1990 as a way to increase only if the shareholders are the company's creditors where they own shares. In practice there was observed an inconsistent position in terms of requests for the capital increase in this way. It has been estimated that by the share capital increase

method through the conversion of debt into equity there is a violation of the art.215 the paragraph 2 of the Law 31/1990 prohibiting the contributions in debts to increase the capital of joint stock companies (ORC Constanta).The provisions of the art.215 par.(2) of the Law 31/1990, republished, and those stipulated by art. 210 par. (2) of the same law refers to some totally different situations, the first referring to the debts of the shareholders towards others,third parties towards the company, the second referring the situation of the shareholders' debts towards the company, recognized by the latter through the entry in the accountable record.

The prohibition mentioned in the art. 215 par.(2) of the Law 31/1990, republished, is referring only to the debts held by the shareholders against a third party and not against the company. This is because, in the case of debts held against the company by the shareholders, according to art. 210 par. (2) of Law 31/1990, the share capital increase by offsetting claims is certain, liquid and payable in shares of the company. The capital increase in the form permitted by art. 210 par. (2) of the Law 31/1990, republished, the increase of the capital is made by the compensation of the certain debts, liquid and due, with the company's shares. The capital increase in the form allowed by the art.210, par.2 of the Law, namely by the compensation of the shareholders' debts over the joint stock companies issued in exchange, doesn't constitute a capital increase through contribution in debts as the contribution of a debt operation is a cession of debts.[7]

Likewise, the art. 16 par. (3) of the Lew, and the exception invoked by art. 215 par. (2) of the Law refers only to the contributions in debts, without expressly specifying the type of the debt (the shareholders - the third parties or the shareholders - the company), but from the reference made at the release of the debt according to art. 84 of the Law it results that it refers only to a shareholder's debt over a third party and not to the shareholder's debt even over the joint stock company.

## 10. Conclusions.

The share capital increase by issuing new shares for the conversion of its debts with

these shares is reflected in the Article 210 of Law 31/1990, paragraph 2, according to which the new shares issued to raise the capital may be released by offsetting receivables and due debts over the company with its shares. By analyzing this text it results that, in order to carry out the capital increase in this way, it is necessary to fulfill the following conditions:

- To have a certain liquid and due debt of the company, towards a creditor, resulting in a debt title recorded in its financial documents;
- The creditor must be a shareholder of the Company;
- The creditor must declare his intention to subscribe having the agreement of the majority.

After fulfilling these conditions, the compensation operations between the two liabilities can be done: 1) The obligation of the company towards its shareholders, on one hand (resulting from a title of debt registered as valid) 2) The obligation of the shareholder to pay to the company the amount for the subscribed shares. Thus, the amount due to the creditors, according to the liquid and due debts that they have towards the company can serve to the payment of the new shares of the company. In exchange for the debts towards the company, its creditors receive shares. The way to increase the share capital is also known as the increase of the share capital through the conversion of the debt into shares of the company, method expressly underlined by the Law of the Companies. Basically, this method is performed by an accountant operation consisting in providing sums of money between the passive accounts of the company.

Regarding the accounting records of the two mutual debts, according to the Accounting Law no.82/ 1991 republished and to regulations governing the companies' accounting, the companies' general chart of accounts contains accounts with the accounting service of assets, accounts with the accounting service of liability and bi functional accounts. There is no need to check the reality of the liquidity and chargeability because these checks have been carried out before enrolling the debt in the accounting records.The process of capital increase by compensation (conversion) is not a contribution in kind or in cash or

contribution in debt but a scriptural currency conversion.

The article 139 of the Order nr.2.594 / C / 2008 approving the Methodological Norms regarding the manner of keeping the registers of trade, and making the records and the release of the information, the legislator states that "at the request for the registration of the note on share capital increase by the conversion of certain debts, liquid and payable over the joint stock company it is attached the modifying document, in original, the document proving the debt, and the balance accompanying financial statements and the evidence on legal and judicial stamp duties in the original."

Moreover, in this sense the judicial practice ruled in the field [8]: "The Court notes that indeed, the assimilation of this method of increasing with a contribution in kind is objectionable, since the assets of the company do not reveal a new good, nonexistent before the increase. The conversion of the debts in shares represents, essentially, some operations through which amounts of money due to the creditors, based on liquid and payable debts that they have towards the company, serve to the payment of the new shares of the company and are performed by accounting operations. "

The Court of Appeal of Constanta stated: " In fact, increasing the capital by the compensation the debts over the company with its shares is performed by an accounting transaction of paying some sums of money between the reliable accounts of the company because, having the role of limit to the general pledge of the creditor, the capital must be real, which requires constantly ensuring in the assets of the company of some goods whose value is not less than the share capital".[9]

Regarding the raised issues in relation to the interpretation of legal texts , obviously , it is possible to increase the capital of a joint stock company by converting its debt into shares of the company , this being a practical method to increase the efficiency of the company's activity .

## 11.References

- [1] The Law no. 31/1990 about the companies modified and completed by the Law no. 441.2006
- [2] Contributions in claims have the legal status of the contributions in kind, not being admitted to limited companies which are established by public subscription or to companies limited by shares or limited liability companies"  
(Article 16 paragraph 3 of Law 31/1990)
- [3]Smaranda Angheni,Commercial Law,The Professionals-TheMerchants,Ed.C.H.Beck, Bucharest, 2013, p.232-233;
- [4]VasileNemes,Commercial Law,Ed. Hamangiu, Bucharest, 2012, p. 160
- [5] Ioan Schiau, Titus Prescure, The Companies' Law, 2000, p. 623
- [6] Cristian Gheorghe, Romanian Commercial Law, Ed. C.H. Beck, p. 353
- [7] Stanciu Carpenaru,Treaty of Romanian Commercial Law,Ed . C.H. Beck, Bucharest 2014
- [8] The Court of Appeal Cluj, The Commercial Division of Administrative and fiscal Division, The Decision no. 14 of 27<sup>th</sup> of June 2007
- [9] C.A. Constanta, The Trade, Maritime and Riverine Division and The Administrative and Fiscal Department Causes, The Decision no. 1283 / COM of 28<sup>th</sup> of June 2007, the Courts of Appeal Bulletin no. 4/2007



# The Economic Impact of the Collective Dismissal Procedure Performed at the Level of an Insolvent Employer

Luiza – Corina Mihai  
Titu Maiorescu University Bucharest  
[mihailuiza89@gmail.com](mailto:mihailuiza89@gmail.com)

## Abstract

*In the context of frequent legislative changes occurring in business and especially in the regulating state of economic difficulty that might find a company, this study deals with the impact of the economic changes which an insolvent employer goes through on its employees, the measures that can be taken and regulations pertaining to this matter in terms of attracting new domestic legislative changes to align Romanian legislation with the European one.*

**Key words:** Dismissal, Collective, Information, Consultation, Employees

**JEL :** G38, K20, E20, F66, G28

## 1. Introduction :

This relationship between employer and employees during collective dismissal procedure is a measure of protection for the employees, or simply a method of prevention in a convenient approach of an employer? This analysis is of particular importance, being the central element of research and examination of the novelty especially in legal research material from Romania in aspects of social dialogue. We cannot know exactly what involvement currently has a healthy social dialogue at company level where very few companies in Romania follows the laws in this matter accurately or not regulated clearly aligned with those of the EU, especially at the level of an insolvent employer.

## 2. Definition Of Collective Redundancies. Issues Related To The Protection Of Employees In The Event Of Collective Redundancies At The Level Of An Insolvent Employer.

The definition of a "Collective redundancy" is strongly related to the number of employees that are dismissed throughout a regulated period of time. Summarily, it means the dismissal, within a period of 30 calendar days, for one or more reasons not related to the employee, namely a number of:

- a) at least 10 employees if the employer performing dismissal has more than 20 employees and less than 100 employees;
- b) at least 10% of employees if the employer dismissing employees has at least 100 but less than 300 employees;
- c) at least 30 employees if the employer has at least lay off 300 employees.

A dismissal for reasons not related to the individual employee's termination of employment is determined by the abolition of the position held by the employee, for one or more reasons not related to his person.

Also, taking into account the employees whose individual employment contracts terminated by the employer of one or more reasons not related to the employee, provided there are at least five redundancies.

Besides internal regulations, this matter is regulated at European level by **Directive 98/59 / EC of 20 July 1998** on the approximation of the laws of the Member States relating to collective redundancies. The Directive, now still in force, defines collective redundancies as dismissals effected by an employer for reasons not attributable to individual workers when they concern a minimum number of people over a certain period.

One interpretation aims the concept of collective redundancy which "does not necessarily need an economic reason, dismissal does not have to be a dismissal for economic reasons or because of a crisis, but must be of a " objective" character for the

reason for dismissal shall not be charged to the worker. "[1]

However, given the theme of the article, we will consider a dismissal for economic reasons.

In the Romanian law system, the Directive was transposed by **Art. 69 Law 53/2003 - Labor Code**, republished, who took a first faithful impression on the provisions of the Directive regarding collective redundancies. If we aim though for a critical analysis of both the provisions of the Directive but also the Labor Code, and the way they are implemented, we will find that the provisions of the Directive have been transposed almost true to form, but they may need improvements in substance, especially when we consider the interpretation CJEU in application in other Member States.

The notion that our legislature system has given to the insolvency matter - **Law no. 85/2014 on insolvency procedures and to prevent insolvency**, decided to be used to highlight the employment relationship in not the specific labor law sphere, but one with its own specific. The law states that "After opening date of the insolvency procedure, the termination of individual employment contracts of the debtor`s staff work will be done by emergency by the judicial administrator / liquidator. The judicial administrator / liquidator will provide personnel fired only the statutory period of notice. Where are applicable the provisions of Law no. 53/2003 - Labor Code, republished, as amended and supplemented, regarding collective dismissal, the terms stipulated by art. 71 and art. 72 para. (1) of Law no. 53/2003, republished, with subsequent modifications, shall be reduced to half".

The insolvent employer is bound by the provisions laid down in **art. 5 of Law no. 467/2006**, law transposing the Directive of the European Parliament and the Council no. **2002/14 / EC** that information and consultation of employees through their representatives takes place on the recent and probable development of employment within the undertaking and on any anticipatory measures envisaged, in particular when there is a threat to jobs.

**Under current law**, the judicial administrator / liquidator may terminate with urgency the individual employment contracts

of the staff will be required to follow statutory period of notice. Thus, the provisions regarding the collective redundancies of Law 53/2003 - Labor Code, republished are respected but the deadlines stipulated by this law are halved. Individual employment contracts termination becomes effective pursuant to the decision of dismissal issued by the judicial administrator / liquidator. In the case of collective redundancies deadlines laid down by art. 71 and 72 paragraph (1) of Law 53/2003 they are reduced by half. This regulation follows the solution delivered by the Court of Justice of the European Union in Case **Claes and others - C235 / 10 C- 238/10** regarding compensation duties in the case of collective redundancies. The Court held that art. 1-3 of Directive 98/59 / EC of 20 July 1998 on the approximation of the laws of the Member States relating to collective redundancies **must be interpreted** as applying to an institution following a **court ruling** ordering the dissolution or liquidation for insolvency, even if such a termination, national legislation provides for the termination with immediate effect of the contracts of the workers.

**Prior to the enactment of Law 85/2014**, the insolvent companies are exempt from the obligation to apply the collective dismissal procedure. Art. 86 paragraph (6) of the Law provides that "Notwithstanding the provisions of Law no. 53/2003 - Labour Code, as amended and supplemented, the simplified procedure and if the general procedure of entry into bankruptcy, termination of individual employment staff emergency debtor will be made by the liquidator, without requiring completion of the collective dismissal procedure. **The liquidator shall give notice to personnel fired only 15 days.**"

Therefore, immediately loosen the individual employment contracts of the employees, only giving a notice of 15 working days. However, following numerous issues occurred in practice and **in the light of European legislation** mandating the contrary, on 02.24.2015, by **Decision No. 64 Published in the The Official Journal of Romania no. 286 / 04.28.2015**, the **Romanian Constitutional Court admitted the exception of unconstitutionality of art. 86 para. (6)** first sentence of Law no.

85/2006. Except admitting Court has held that this exemption the legislature of insolvency law does not respect the right to information and consultation of employees provided for by art. 41 paragraph 2 of the Constitution and the failure to harmonize the Romanian legislation with European art provided. 148 (2) and (4) of the Romanian Constitution (Implemented by art. 2 of Directive no. 98/59 / EC).

### **3. Insolvency. Proceedings. Definition And Effects**

In economic terms, insolvency reflects the debtor's inability to meet debt falling due. Insolvency constitutes a manifest inability to pay debt, so an objective state of the heritage, characterized by a lack of the money available to pay debts of the debtor.[2]

In the romanian legislation, insolvency is reflected in the Law no. 85/2014 in which that Article 5 pct.29 defines insolvency as "the state of the debtor's assets which is characterized by insufficient funds available to pay clear , and matured debts, so :

- i) insolvency of the debtor when it assumed after 60 days of the due date has not paid his debt to the creditor; the presumption is a relative one;
- ii) insolvency is imminent when it turns out that the borrower can not pay the outstanding liabilities incurred due with available cash funds on the due date;

The current regulation is taken into consideration as a cause of trigger procedure cessation of payments by the debtor or unable to make payments when due. Therefore, the debtor is unable to cope outstanding commercial debts and its assets - money required payments are either nonexistent or insufficient, and they have no receivables, so they are unable to pay.

In the legal sense, "financial difficulty" is a deficitary state of the debtor's assets that do not enable them to honor their financial pecuniary obligations due to unavailability of funds..An important condition that the debts must be met is that it must be certain, liquid and payable. The claim is uncertain whether its existence is questionable and unquestionable. The claim is payable when the debt is matured and can be claimed, which may be required performance, even

foreclosure. The claim is liquid, if the claim whose object is an amount, expressed in lei or foreign currency or in an amount of generic goods.

Proof of lack or insufficient money of the debtor, defining feature of the cessation of payments, lies directly in the conduct of the debtor who can not pay his debts, and indirectly, when the debtor resorts to fraudulent means or ruinous (borrowing, selling at a loss , issuance of bad checks, and others). Therefore, the court is the only one to appreciate the debtor's conduct in its relations with third parties and traders of means but also on the existence of the means needed for the debtor to perform or not the payment and determine if it is in a cash impairment.

The cease of the payments is a condition of the debtor, expressing its inability to pay outstanding trade payables due to lack of liquidity.

As soon as the insolvency proceedings are opened, priority measures to be taken at this point of the procedure are numerous. A procedural incident is that all judicial or extrajudicial actions for recovery of debts (arising prior to the opening of insolvency proceedings) against the debtor or its assets are suspended, unless the creditor holds a claim secured by mortgage, pledge or other security interest or right retention. The statute of limitations is suspended and will resume its course 30 days after completion of the procedure. The flow of interest and penalties is also suspended.

### **4. The Link Between Insolvency And Labor Relations:**

Binding the above, because some employers are in economic difficulty -and can not operate under the same financial conditions because of salary claims which are too onerous which it is at the time, either because some agreements, such as, collective labor agreements in force at the unit generate excessive costs for the economic problems at cause, are forced to give up wage costs of the numerous staff members (relative to the actual needs of staff related to the volume of activity) and therefore to appeal the termination of contracts.

An employer can easily become an insolvent one, and for that it is sufficient that the debtor did not comply with the obligation of payment towards its employees. However, because this situation often leads to termination of employment, the employer's employees are among the last creditors that would have an interest for the employer to be in a state of insolvency. The termination of the contract under the insolvency may have consequences for the employee more than unfavorable to the termination of individual employment contracts in other ways provided in labor legislation.

Therefore, a solution for the costs representing salaries which are too onerous is reducing the number of existing employees at the time of the occurrence of insolvency, namely dismissal for reasons not related to the employee. If the employer has to lay off a large number of employees for these reasons the procedure is named "collective redundancies".

### **5. The Employer Obligation Of Complying The Fundamental Right To Information And Consultation**

Informing and consulting employees is an essential application of social dialogue, which also has economic implications.

The information and consultation of trade union or employee representatives for collective dismissal provisions in Directive 98/59 / EC were generally correctly and completely transposed into national law by art. 69 of the Labor Code.

According to the text of law, if the employer intends to make collective redundancies he shall initiate timely and aimed at reaching settlement consultations with trade union or employee representatives, of at least:

- 1) the methods and means of avoiding collective redundancies or reducing the number of employees to be made redundant and
- 2) mitigating the consequences of redundancy through the use of social measures aimed, inter alia, support for retraining or retraining of dismissed employees.[3]

To enable trade union or employee representatives to make proposals in due time, the period during which consultations take place, the employer is required to

provide all relevant information and notify them in writing.

If the decision determining the collective redundancies is taken by an undertaking which controls the employer, it cannot rely, if not strictly meet the information and consultation obligations referred to above provided by art. 69 para. (1) and (2) of the Labor Code, that undertaking has not provided the necessary information.

Regarding this aspect, we note that transposing the provisions of the art. 2 para. (4) the second sentence was made incomplete. According to this text, regarding violations of the information, consultation and notification requirements of the Directive, the employer cannot claim that the necessary information has not been provided by the undertaking which took the decision leading to collective redundancies to justify any violation of all the information, consultation and notification requirements of the Directive. Transposing into Romanian legislation is incomplete since it refers only to the situation in breach of obligations under paragraphs (1) and (2) of art. 69 of the Labor Code and not in any breach of any obligations relating to information and consultation.

Regarding the phrase "timely" as the Labor Code makes no statement about the minimum time that must be respected by employers to initiate collective redundancies for her performance we relate both to the practice of the ECJ and the the purpose for which the provisions of the Directive have been adopted and to enable a dialogue between the parties in order to reduce the negative effects of dismissal, to find solutions for maintaining and protecting the retraining of employees depending on the specific case. Like the provisions of the Directive which determine the point in time of the birth of the obligation to initiate the information and consultation "when the employer is considering making collective redundancies" and Labor Code refers all at birth intentions of the employer accordingly in good time before a decision on collective redundancies has been taken so that it can carry information and consultation process.

The employer has the obligation to initiate information in a sufficient time before the time scheduled for termination of individual employment contracts, to allow real

consultation on the need to conduct good faith in order to reach agreement. How the employer fulfills this obligation is subject to review by the court, at the request of employees' representatives, if they appreciate that they have provided all relevant or if it considers that not see properly, and at the request measure individual employees affected by the dismissal who can ask the court the cancellation of the decision of dismissal if it considers that it was issued without compliance with legal procedures, including the information and consultation.

## 6. Expectation Of Future Regulations:

How can an employer who has no chance of a reorganization of his business, meaning he is in bankruptcy, be obligated to comply to this *fundamental* right given that all its employees will be laid off due to the liquidation of the company? Isn't this procedure too onerous for the employer? Why not use the few assets owned to pay debts and not respect an unnecessary compliance in this case?

It is widely accepted that no one can stop an employer to organize his commercial activity,, but by where it leads this exclusive prerogative of the employer ? Thus , in terms of theory, not only our laws but also to other EU Member States or even other non-EU countries were in constant change in addressing this issue , which is why theorizing not only the concept of collective redundancy , but also its methodology and its implications in terms of business of the employer , that the interference with the rights of employees - to be thorough in this regard need to safeguard the right to work of an employee , whether it is a collective dismissal the employer wishing to reorganization / streamline the work , or an employer in economic difficulty

## 7. Conclusions :

**Easily bypassing the infringement (or not) of the right to information and consultation under the law and directive by reducing the deadline, what are the economic benefits of an insolvent employer regarding dismissals?**

To meet the response, it should be noted that before the entry into force of Law no. 85/2014, the collective dismissal procedure in case of employer insolvency was found in one simplistic, safe condition imposed in the compliance of the notice period (This period was one reduced and the Romanian Constitutional Court ruled that those provisions related to the reduction of the notice period, even in the context of the pronouncement by the High Court of Cassation and Justice, Decision no. 8/2014 in an appeal on points of law was one according to the fundamental Law), and not following the procedure governed by art. 69 of the Labor Code, in particular the provisions related to information and consultation.

Thus, before the entry into force of Law no. 85/2014, the employer was in this special situation, basing its individual labor contract termination on provisions of the art 86 paragraph (6) | Law. 85/2006, not respecting what the fundamental law protects and guarantees, does not respect the right to information and consultation.

In this context it should also be noted however that under the new legal provisions, collective dismissal procedure governed by the common law applies. So the problem that would occur is the answer to the question if the termination of a labor contract under the influence of the new legislation would not respect this fundamental right, but if the procedure carried in this manner violates European provisions, namely those concerning the available time in which the employer must to initiate consultations with workers representatives to reach agreement. Specifically, if we consider the aspects which arise in practice related to the formalism (from the point of view of the employer) of these terms as they enter into consultation, the employer is ultimately the only entitled to initiate this procedure, we might rally to the view that that reduced term does not affect in any way the fundamental right of employees to information and consultation under EU law.

A particularly important aspect in supporting this view would be that, in terms of time, the consultations could not last forever - in common conditions - (see also the difficulties in initiating such proceedings following the refusal of the syndicate to have

a constructive social dialogue), especially for an employer who is having financial difficulties and must act rapidly to sort out the company's financial difficulty, so shorter deadlines are from this point of view in the benefit of the employer.

Therefore, about the infringement, we end by rallying to the view that the new provisions do not contravene the ones imposed by the legislation, given the nature of the special provisions of Law no. 85/2014 which derogate from the Labor Code and considering the protection of the fundamental rights of the employee, could not reach, as in the old legislation where it fully derogated from art. 69 Labor Code, a lack in terms of technical and legal rules for the protection of this right.

Concluding on the economic benefits, we observe that, besides that the costs with the salaries were higher before amending Law no. 86/2006, because the employer would only issue decisions for dismissals and comply with a less period of notice, there aren't too many of these advantages.

No solution should embrace infringement of a fundamental right, but we did not yet connect the purpose of establishing a smaller period of notice when the employer still has to follow the procedure and still has to pay large amounts of money to employees who are occupying the positions the company will surely abolish. Is it true that, the terms being reduced by half, the company has to pay wages throughout a smaller period, but is such help enough? Or is it just an excuse for *punishing* a poor management of a company?

## 8. References :

- [1] Charlton, John, *Redundancy law gets new rules*, Employers Law. Sep2013, pag. 12 - 13
- [2] *Commission Report on the Implementation of the Directive concerning the approximation of the laws of the Member States relating to collective redundancies*, European Commission, 1999
- [3] *Commission Report - Implementation of the Directive on the approximation of the laws of the Member States relating to collective redundancies*, SEC(91) 1639, European Commission, 1991
- [4] Cullinane et al., *Triggering employee voice under the European Information and Consultation Directive: A non-union case*

*study*, Economic and Industrial Democracy, 1–27, 2015

- [5] Dima, Luminița, *Termination of Employment Relationships: Legal situation in Romania, National Study Report*, European Commission, August 2006
- [6] Dr. Kresal, Barbara, *Termination of Employment Relationships Legal situation in the following Member States of the European Union: Bulgaria, Cyprus, the Czech Republic, Estonia, Hungary, Latvia, Lithuania, Malta, Poland, Romania, Slovakia and Slovenia*, European Commission Directorate General Employment, Social Affairs and Equal Opportunities Unit F2, Ljubljana, March 2007
- [7] Miguel Rodríguez-Piñero, Bravo-Ferrer, „La noción comunitaria de despido y el momento oportuno de la consulta” („Noțiunea comunitară de concediere și momentul oportun pentru consultare”), *Revista Relaciones Laborales*, N° 22, Sección Editorial, Año XXV, pág. 97, tomo 2, Editorial La Ley

“This work was supported by the project “Interdisciplinary excellence in doctoral scientific research in Romania - EXCELLENTIA” co-funded from the European Social Fund through the Development of Human Resources Operational Programme 2007-2013, contract no. POSDRU/187/1.5/S/155425.”

## The Corporate Governance of Public Entities in Romania – Necessity or Formality?

Marioara Mirea

*OVIDIUS University of Constanta, Romania, Faculty of Economical Sciences*

[mm\\_mirea@yahoo.com](mailto:mm_mirea@yahoo.com)

Ionela Munteanu

*Bucharest University of Economics Studies, Romania, Doctoral Study Programs*

[consultant.munteanu@gmail.com](mailto:consultant.munteanu@gmail.com)

### Abstract

*In Romania, the implementation of the regulations on corporate governance in public enterprises started as a requirement of the European acquis.*

*This research examines whether the directives transposed into the national legislation, with the adoption of the Government Emergency Ordinance (GEO) no.109 of 30th November 2011 on the corporate governance of public enterprises, and with their approach in practice, meet the EU requirements.*

**Key words:** corporate governance, public entities, internal control

**J.E.L. classification:** M42, M48

### 1. Introduction

Across time, the concept of governance has known definitions and assessments from various perspectives, which influenced the level or the scope to which it has been reported. Fundamentally, governance concerns the decision makers interested in its implementation; it involves setting objectives and establishing the methods, techniques and responsibilities necessary for the achievement of these objectives.

Therefore, we can talk about governance at corporate, sectoral, national, European levels; there are obvious subordination relationships between them but there are also coexistence relationships triggered by their common goals. In Europe, the economic objectives of the European Community have resulted in conventions, treaties or resolutions, applicable to all acceding

countries. By signing the Treaty of Maastricht, in 1997, the signatory states agreed on common guidelines for the creation of a single currency and the establishment of convergent rules concerning admissible public deficits. This was the starting point of the EU multilateral governance system, defining the objectives, strategies and procedural elements incident to all subordinated governance systems.

The need to adopt uniform policies in order to achieve EU macroeconomic and financial stability, the Member States adopted the Stability and Growth Pact, which entered into force on 1<sup>st</sup> January 1999. There have been established a set of preventive rules along with corrective elements; there were assumed responsibilities and budgetary objectives, affecting all the economies and geopolitical strategies of the EU member countries.

Governance strategies have evolved over time; thus, at present, the national governance provisions are proposed to complement the EU framework. "National institutions could play a more prominent role in budgetary surveillance, in order to strengthen the enforcement of standards through the national public opinion and to complement the economic and political analysis at the EU level." [1]

It is the responsibility of each member country to identify those "national institutions" that can provide relevant information or that can support the supervision of the substantiation and execution of the national budget. The adjustment of the legislation in the field, under the influence of geo-political and domestic socio-economic factors, drew the governance reference lines at corporate level

among "the national institutions" of interest.

## **2. The need to implement the corporate governance of Romanian public entities**

In order to meet the EU requirements, even in the pre-accession phase, Romania has adapted its legal framework, in the view of compliance.

The need to implement governance in the local public sector springs from the Commission's evaluations and recommendations, in view of Romania's accession. Thus, at an early conceptual level, the governance from the Romanian public sector crystallized by implementing a set of rules recommended in order to strengthen the functions of the internal financial control, pursuant to the opinion issued by the European Commission, in 1997. The actions taken by our country to comply and strengthen the functions of the public internal financial control targeted legislative harmonization and constitutional changes in order to provide independence to the members of the Court of Auditors, to strengthen the administrative capacity of the Court and to outline the managerial framework of structural funds. [2]

Under the commitments made by Romania regarding the accession to the European Union, we became aware of the need to implement "a new type of management" [3] in "national institutions". The process has resulted in the enforcement of the internal control and of the preventive financial control, by Ministry of Public Finance Order (MPFO) no. 119/1999 and, subsequently, by regulating the internal public audit, established by Law no. 672/2002.

In Romanian law, the concept of "national institution" has been assigned to the correspondent of "public entity", with specific reference to all "public authorities, public institutions, national companies, autonomous administrations, trading companies where the state or an administrative-territorial unit is shareholder, with legal personality, using/managing public funds and/or public patrimony". [4]

The corporate governance in the public sector lies in establishing a set of objectives, programs and strategies by senior management factors, along with the

implementation of convergent rules, in order to achieve good financial management. Good financial management is an obligation of those responsible for the management of public entities and implies "ensuring the legality, regularity, economy, efficiency and effectiveness in the use of public funds and in public assets management" [4].

The strategic planning conducted in order to achieve properly the assumed objectives involves, at the level of principles, maturity in identifying and managing the risks identified in the entity [5], reconciling the shareholders and the managers' interests [6], implementing and supporting the internal management structures [7], adopting an ethical and responsible behavior.

The new generation of management practices is reflected in the paradigm of *the new change management* [8], promoting a set of principles and practices that aim to create participative organizations, where the collaboration of members contributes to the rapid identification of the deficiencies in performance and of their solutions, stimulating creativity, by pooling ideas from people of different levels and functions, together with suppliers, customers and other stakeholders.

The need to implement corporate governance in Romanian public entities was realized due to the evolution of the regulatory framework at the European level, in the light of the recommendations made directly by the European Commission.

## **3. The comparative evolution of the regulations on the corporate governance of Romanian public entities, in connection to the EU requirements**

The European legislation has undergone great change in terms of establishing economic governance rules, applicable to all Member States. The pillars of sustainable economic growth are: good governance of public finances, avoidance of excessive deficits, strengthening the surveillance of budgetary positions and the surveillance and coordination of economic policies – these are values of the European economic culture.

The deep economic crisis recorded globally has made clear that an ambitious reform of the governance framework of public sector entities, supported by stable



fiscal policies and better monitoring and economic coordination, are also in deep and general interest of every nation from the European space, but also for the EU itself, in order to support the euro zone.

The need to regulate governance in public entities has been felt mainly since 2008, when it was found that the deficit of these entities amplified the consolidated budget deficit. Transition economies tend to have a larger number of companies with state capital, so that their improper management has a strong echo in the results of the consolidated budget.

Romania's legislative compliance towards establishing the essential criteria of European economic governance began early, since the pre-accession phase, but without a strong practical resonance across time. Romanian public entities governance reform has a significant impact on domestic economy, given the large number of state enterprises (1525 on 6/30/2014), the significant share in GDP (11.4% of GDP in 2013) and the large number of employees (7.5% of the working population of the country). [10] (Fig. 1) Also, according to OECD statistics, Romania is the country with the most companies where the state holds a participating interest, throughout the European Community (Table 1).

Figure no.1. The division of public entities according to shareholders

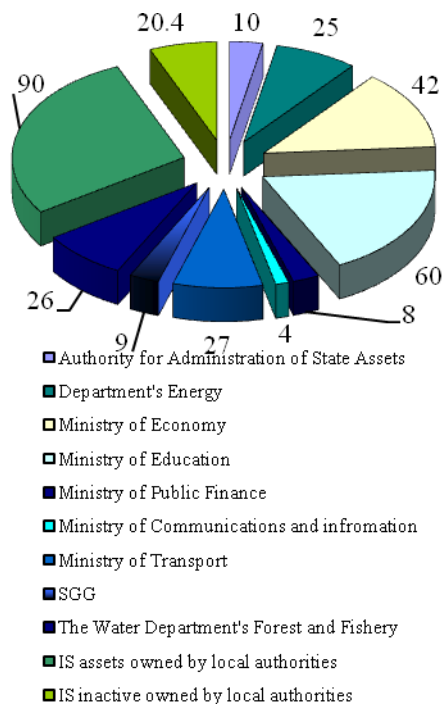

Source: Database of the Ministry of Public Finance

Table no. 1 State enterprises in OECD European countries

Country (year: 2009)	Total no.	Of which	
		Trading companies with majority state capital	Legal public entities (autonomous administrations)
Austria	11	10	1
Belgium	8	8	0
Czech Republic	124	83	41
Denmark	15	13	2
Estonia	54	32	22
Finland	45	40	5
France	60	41	19
Germany	62	60	2
Greece	82	82	
Hungary	359	347	12
Italy	28	28	0
Holland	28	28	0
Norway	51	41	10
Poland	590	590	
Portugal	93	42	51
Slovenia	37	37	
Spain	152	116	36
Sweden	50	46	4
Switzerland	4	2	2
UK	22	14	8
Romania, (year: 2014)	1528	1419	109

Source: Christiansen, H. [9]

### 3.1. The adoption of the Internal Control Code Management

The *acquis communautaire* sets, as far as internal control is concerned, the implementation of the general principles applied to the specifics of each member state. Internal control is defined as "a management tool used to provide reasonable assurance that the management's targets are met" or "an effective tool in order to prevent corruption and fraud" [11].

When drawing up the country report in October 2004, in Chapter 28, European Commission mentioned the need for a

convergent system of management rules, while defining an organizational framework at the level of public entities.

In Romania, the creation of the organizational framework specific to the development and monitoring of corporate governance in the public sector was done by approving the Internal Managerial Control Code, under MPFO no. 946/2005.

The order was republished and amended by MPFO no.1423/2012, with new regulations regarding the format and the deadlines for reporting on the implementation stage, and on the development of the managerial/ internal control; this order was repealed in 2015.

A new regulation was approved, i.e. the Order no. 400 of 12<sup>th</sup> June 2015, in order to set the Code for the managerial/ internal control of public entities; it included a reclassification of the reference standards of public entities regarding the internal managerial control. This is how there has been achieved a reconsideration of both the number of the standards used in assessing the compliance with the internal managerial control systems (the new code contains a total of 16 standards, which replace the 25 standards stipulated by the old legislation), as well as a reconsideration of their contents. The new standards acquired a practical logic at the expense of the formality of the old regulations. The reference legislation for every standard was reviewed; the duties of the managers of public entities have been clarified and it has been paid a high level of attention to accounting and financial reporting, through a specific standard.

The results of the new regulations are to be quantified, based on the reports that begin their applicability. It is difficult to foresee their practical utility, given that the application of the old Code of managerial internal control was limited mainly to matters of formality, without recording any quantifying improvement of the activities of Romanian public entities as a result of its implementation, as revealed by the analysis of the global indicators for assessing governance, presented below.

### **3.2. Regulating the concept of corporate governance of public enterprises**

The necessity of organizing complex

management systems in the public sphere, orientated towards carefully grounded objectives, focused on monitoring, prevention and control, is long-debated and comprehensively regulated by Community legislation.

According to the Organization of Economic Cooperation and Development (OECD), the ethical behavior of corporations, the guarantee of objectivity, transparency, professionalism and responsibility of the managerial decision are criteria to be included in the selection of managerial factors, in both private and public enterprises.

Based on these considerations and given the fact that improving the corporate governance of state enterprises is an objective assumed by the Romanian Government Letter of Intent to the IMF, approved in 2011, the Government approved the Emergency Ordinance no. 109 of 30<sup>th</sup> November 2011 on the corporate governance of public enterprises. Thus, there were set new rules on the choice of the management factors at the top of public entities and on monitoring their performance. The Ordinance was amended as far as the regulation of the remuneration of managers (GEO no. 51/2013) or the mandate of interim managers (GEO no. 10/2015) is concerned.

Until now, the practical application of the emergency ordinance has not proved to be a success. In more than 200 enterprises from the portfolio of central government, the process had not even started by the end of 2014. Given that the adoption of the ordinance was intercepted by the public opinion as a saving solution for Romanian public entities, in practice it was implemented mainly formal, the political interference being undeniable in many situations, or it was not implemented at all. [10]

### **3.3. The coordination of the budget process**

The reform of the EU rules after the recent financial crisis – introduced by the package of six legislative proposals (*six-pack*), by the package on budget supervision and monitoring (*two-pack*) and by the Treaty on Stability, Coordination and Governance in the Economic and Monetary Union (Fiscal

Treaty) – established a new system for the supervision of budgetary and economic policies and a new budget policy calendar, i.e. the budgetary semester.

The Stability and Growth Pact becomes broader and more predictable through a considerable improvement of the EU rules on economic governance, through a new set of laws ("the economic governance package").

The new rules lay down the requirements regarding the accounting system in the public sector and the condition of internal control and its independent auditing, the *budgetary and statistical reporting*, the forecasts for multiannual fiscal planning, the numerical fiscal rules, the budgetary framework on the medium term (budget planning for at least 3 years) and the rules for the transparency of public finances.

The implementation of the European system aims at a better coordination of Member States' policies, clarity of implementation and deadlines, periodic monitoring and better-defined sanctions for the breach of rules.

Romania sought to transpose these rules by adopting the Law no.69 / 2010 on fiscal responsibility. The rule on the structural budget deficit, on finding deviation from it and on the automatic correction mechanism in case of deviation were introduced into the national legislation by amending this law, i.e. by adopting the Law no. 377/ 2013, which entered into force on 1<sup>st</sup> January 2014. At the same time, the transposition at the national level of the European reference indicators and of the budgetary substantiation rules was done by approving the Methodological Norms on drafting the income and expenditure budget by businesses (covered successively in the period 2000-2015).

According to the European demands, Romania reports periodically on the evolution of the economic growth and of budget deficits, by comparing several methods:

- The ESA budget deficit (European System of Accounts) or the method based on commitments ("accrual"): "according to ESA flows are recorded on an accrual basis; that is when economic value is created, transformed or extinguished, or when claims and obligations arise, are transformed or are cancelled". [12]

- The structural budget deficit, calculated

by cyclically adjusting the budget deficit, by deducing the exceptional measures and the temporary measures. Schematically, the determination of the structural deficit is based on the identity:

$$\text{Actual budget deficit ("cash")} = \text{Structural deficit} + \text{Cyclical component}$$

In Romania, in the period of rapid economic growth before the financial crisis of 2008, the fiscal policy was based on temporary and exceptional (pro-cyclical) measures, thus inevitably triggering the imbalances accumulated in the economy during the crisis (Fig.2)

Figure no.2. The evolution of the economic growth and of the budget deficits in 2008-2017

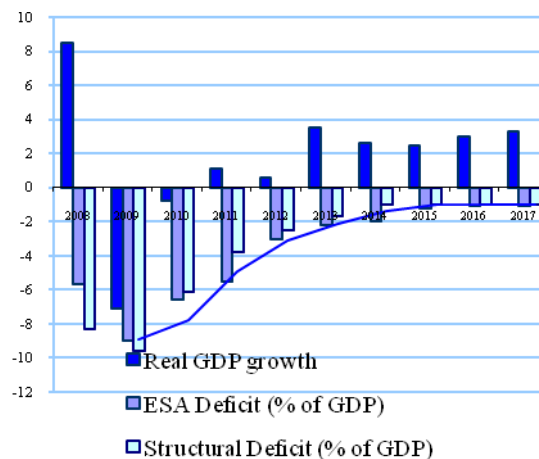

Source: PFM, Eurostat, PFM, The budgetary and fiscal strategy for the period 2015-2017.

Analyzing the data in the table above, we can see that during the onset of the financial crisis, respectively in the period 2008-2011, Romania registered the greatest budget deficits from the analyzed period. This has significantly hampered its economic growth and stability in the coming period. In order to correct the situation, the fiscal policies implemented after 2011 were aimed at improving the government revenue collection system, increasing fiscal predictability and improving the absorption of European funds.

#### 4. The perceptions on the corporate governance of Romanian public entities

In the context of the regulations on

corporate governance, applicable in our country for more than a decade, only during the recent years, topics such as the impact of corporate governance on the reflection of the activity of autochthonous public entities and of the financial reporting and accounting methods began to be more frequently discussed by state control bodies. Until the recent years, the legislative framework in the sphere of local public entities materialized mainly in the formal plan, without relevant practical consideration. It aimed mainly at harmonizing the national legislation with the European standards, but without resonance on the practical plan.

The results of implementing corporate governance policies can be quantified by multiple methodologies and indicators. Thus, the governance implemented at the level of public entities can be assessed in terms of indicators such as budget compliance, arrears, the cost of ensuring the observance of contracts, exports, occurrence of insolvency or bankruptcy etc.

The World Bank implemented a project - Global indicators of governance (WGI), which tracks the aggregation of a suggestive number of indicators in order to measure governance nationwide. The indicators centralize the perceptions of a number of companies, experts and citizens from different countries, based on questionnaires.

The definition of governance that led to the structuring of the WGI database is "the traditions and institutions by which authority is exercised in a particular country. These include the processes by which governments are selected, monitored and changed, the government's ability to formulate and implement viable policies and the compliance by citizens and by the state with the institutions that govern the economic and social interactions among them" [13].

The proposed global indicators assessing governance are calculated based on the respondents' perceptions; these are:

- *Voice and Accountability* (participation in selecting the government, as well as freedom of expression, freedom of association or freedom of the press)
- *Political Stability and Absence of Violence/Terrorism*
- *Government Effectiveness*, which aims at measuring the perception on the quality of public services, of the civil service and of its

independence when faced with political pressure

- *Regulatory Quality* (the government's ability to formulate and implement viable policies and regulations that allow and promote private sector development)

- *The rule of Law* (the extent to which state agents trust and observe the rules of society, especially in terms of quality of contract enforcement, property rights, police and courts, as well as the likelihood of crime and violence)

- *Control of Corruption*

Figure no. 3. The evolution of the global indicators for assessing the governance in Romania, in 2010-2014

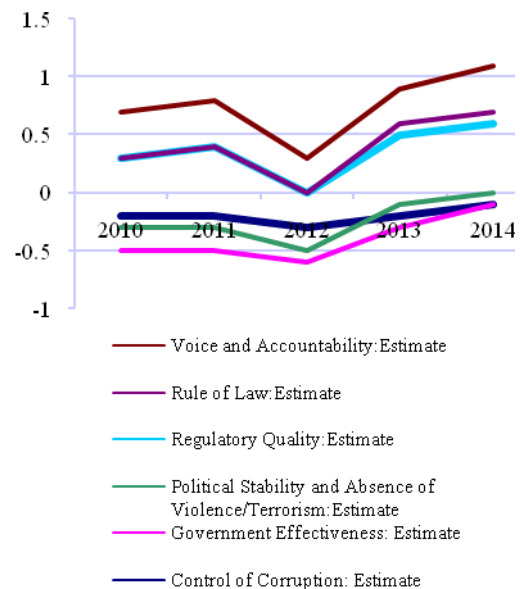

Assessment results: 0 - the lowest 1 - the highest

Source: World Bank. Worldwide Governance Indicators

By analyzing Figure no.3, we can conclude that Romanian public entities are perceived as favoring bureaucracy, formalism and overregulation, over transparency and boosting competitiveness. The perceptions regarding the quality of public services, the implementation of policies, government credibility and accountability are marked by skepticism and mistrust, amid constant corruption and political pressure.

Since the end of 2013, there can be noticed a slight change in the public perception of governance, driven by justice reforms and by the consolidation of the

institutions that fight against corruption. [14]

## 5. Conclusions

The improvement of the regulatory framework for corporate governance, established by GEO no.109/2011, is necessary.

At present, the legislation provides for the obligation of compiling, for the same public entity, both a management plan and an administration plan. The current provisions should be reviewed, given the conflicts that may arise in setting goals and quantifying their achievement by performance indicators (e.g., in the case of common objectives of both board members and the executive management, there may be divergences about responsibilities, namely the assignment of performance indicators). The consequences of such conflicts or misunderstandings regarding the establishment of managerial accountability can also be reflected in remuneration. For the common objectives and indicators of several key decision factors, there may be disagreements about the division of responsibilities.

We should also encourage the appointment of politically independent specialists, in the senior management of public entities, concurrently with greater transparency, as far as the reporting about the condition and performance of public entities to the public is concerned.

## 6. Bibliographical references:

- [1] Comunicare a Comisiei Europene către Parlamentul European, Consiliul European, Consiliu, Banca Centrală Europeană, Comitetul Economic și Social European și Comitetul Regiunilor, nr. 367 /30.06.2010
- [2] Raportul de țară, Comisia Europeană, 6 octombrie 2004, *Capitolul 28: Controlul financiar*
- [3] Ministerul Finanțelor Publice, Unitatea Centrală de Armonizare a Sistemelor de Management Financiar și Control, *Indrumar metodologic pentru dezvoltarea controlului intern în entitățile publice – 2005*, [www.mfinante.ro](http://www.mfinante.ro)
- [4] Ordonanța nr.119/1999 privind controlul intern și controlul financiar preventiv, republicată și modificată
- [5] Beasley, M., Branson, B., Hancock, B., *Current State of Enterprise Risk Oversight: Progress is Occuring but Opportunities for Improvement Remain*, studiu elaborat în colaborare cu AICPA (American Institute of Certified Public Accountants) în cadrul North Carolina State University, 2012
- [6] Damian, M.I., Mănoiu, S.M., Bonaci, C.G., “Mecanismul intereselor compatibile: un set de reforme privind guvernarea corporativă”, *Audit Financiar nr.3*, 2014
- [7] Peculea, Dumitrescu, A., “Governance process improvement and development by audit consolidation”, *Theoretical and Applied Economics*, vol. XXII, no.2 (603), pp. 215-222, 2015
- [8] Axelrod, R.H., *Terms of Engagement: New Ways of Leading and Changing Organizations*, ed. a II a, Berrett-Koehler Publishers, San Francisco, 2010, pp. 6-7
- [9] Christiansen, H., “The Size and Composition of the SOE Sector in OECD Countries”, *OECD Corporate Governance Working Papers*, No. 5, OECD Publishing.  
<http://dx.doi.org/10.1787/5kg54cwps0s3-en>, 2011
- [10] Ministerul Finanțelor Publice, *Raport final privind evaluarea implemmentării Ordonanței de Urgență nr. 109/2011*, 2014
- [11] The International Organisation of Supreme Audit Institutions (INTOSAI) - INTOSAI GOV 9100 - *Guidelines for Internal Control Standards for the Public Sector*
- [12] Manual on Government Deficit and Debt - Implementation of ESA 2010 - 2014 edition, Seventh edition, available on <http://ec.europa.eu/eurostat>
- [13] Worldwide Governance Indicators, [Online] disponibil la adresa <http://info.worldbank.org/governance/wgi/index.aspx#doc>
- [14] *Raportul de țară al României pentru 2015 Inklusiv un bilanț aprofundat privind prevenirea și corectarea dezechilibrelor macroeconomice*, Document de lucru al serviciilor Comisiei Europene, Bruxelles, 26.2.2015

## January Effect and Market Conditions: a Case of Romania

Aurora Murgea

Department of Finance, Faculty of Economics and Business Administration

West University from Timisoara

[aurora.murgea@e-uvt.ro](mailto:aurora.murgea@e-uvt.ro)

### Abstract

*One of the first steps in discovery is the awareness of anomaly. Very often nature violates the expectations that rule the normal science. This paper examines the anomalies that can arise on capital markets, with an emphasis on the January effect. Several hypotheses are proposed in order to explain the abnormal returns recorded by small firms in the first month of the year: the window-dressing hypothesis, tax loss selling hypothesis or the 'not so rational' behaviour of the investors. Using the BET index from 2000 to 2014 and a dummy variable as a proxy for January effect, it can be noticed that Romanian capital market seems to be prone to experience higher returns especially in the less volatile period, as the one before the crisis.*

**Key words:** capital markets, anomalies, January effect, efficiency

**J.E.L. classification:** C2, G14, G17

### 1. Introduction

Many years financial decision theory was dominated by the concept of market efficiency proposed by Eugene Fama in 1970. He gathered earlier theoretical and empirical work and developed what we know as the Efficient Market Hypothesis (EMH). According to his research, an ideal market is considered the one where all the available information regarding a stock is fully reflected by its price at any given time. There are no transaction costs, information is available for free to all the players in the market and besides, they are all rational economic agents.

After 20 years Fama turns back at this theory and admits that pure market efficiency should be seen more as a benchmark for

determining which fair information and trading costs are rather than a real world possibility. Using an asset-pricing model, [7] reviews his earlier theory and states that before testing if information is properly reflected in prices or not, you must define firstly what "properly" means. Then, even after completing this task, it will still be hard enough to determine whether the anomaly found on the returns' behaviour it is a matter of market inefficiency or a bad model of market equilibrium. Being the base for an overview of the markets at that time, Fama's hypothesis of efficiency opened the doors for positive capital market research. More and more economists started to argue against this theory based on empirical findings. In the beginning, individual psychology and behaviour were not given too much importance. However, data and statistics were disclosing something else. Many anomalies like Monday effect, Weekend effect, pre-holiday return or January effect come to contradict the efficient market theory.

The main question that arises is how much these anomalies can be related to the investors' feelings, emotions and their individual personality? Do all these have a major impact on the decision making when investing on capital markets? It is possible to measure correctly investors' sentiments? When a significant event strikes an economy, many changes (positive or negative) are to be observed inside different fields. These changes appear because people immediately react to unknown situations as they best believe at that moment. The trend is to answer quicker to unfavourable situations, being primarily driven by fear, rather than to favourable ones; a negative effect is faster observed compared to a positive one. Obviously, the price trend to a bad news is downward, while for the good news the price tends to go up. This was the case for the

financial crisis of 2008 as well. Especially in this kind of periods, as a consequence, financial institutions turn more their attention to retail investors trading as they can be a constant source of liquidity. Although retailers are often seen as providers of "dumb money" mostly when trading individually, their impact on the market prices is quite high when acting together. In [2] the author observes a herding behaviour in retail trading opposed to the institutional one where decisions are made according to professional analyses and other expert opinions.

Starting from these researches, the purpose of this paper is to see if there is a January effect on Romanian capital market and if this effect depends in any way of the market conditions. The present paper starts with January effect literature discussion (section II). Data and methodology are described in the third section, analysis is presented in section IV and in the last one are summarized the conclusions.

## 2. January effect - general considerations

One of the most discussed market anomaly is January effect. Many scholars empirically tested its presence and shown that the returns have an abnormal evolution during January. For example, Keim [10] took the market values of NYSE and AMEX common stocks and examined the empirical relation between them and the abnormal returns they might generate. His study revealed the fact that in January, more than in any of the other eleven months, daily abnormal return distributions have the largest means. The size of a firm and the abnormal returns seem to be inverse related, i.e. the smallest the firm, the greater the effect of the return on that particular firm.

Actually, more than a quarter of the size premium is related to the high abnormal returns recorded in the first trading week of the year and almost 11% just in the first day of the trading activity. Evidence shows that January effect is more a small-size firm effect, maybe due to the fact that small firms trading activity is not that frequent, according to Roll [13], following Scholes and Williams [14]. Wachtel [15] and Branch [1] admit that a possible explanation for the large January returns is the tax loss selling hypothesis, but it is more plausible when assessing countries

that have a different tax-year end than the calendar's one. (UK has a May tax-year end). If the effect of abnormal returns for small firms still stands in the month following the tax-year end, then you may state the tax loss selling hypothesis is consistent with the evidence. Instead, De Bondt and Thaler [4] consider that the price-ratio hypothesis is more relevant in explaining this effect, namely when there is a high P/E ratio the stocks tend to be overvalued whereas when P/E ratio is low, stocks are undervalued. De Bondt and Thaler [4] raised the question if the overreaction of most of the people (as research in experimental psychology suggests, there is a general tendency to overreact to fortuitous and dramatic news events) could affect the stock prices. They observed that individuals tend to base their investment decisions on current information and past excess returns rather than on more accurate variables like long-term dividend paying power or firm earnings. Actually Keynes [9] was among the first economists who observed the overreaction in markets. He stated that the daily fluctuations in profits are given too much importance and influence the market on a higher level than they should do. Moreover, this overreaction is asymmetric – higher for those who lose than for those who register profits. De Bondt and Thaler tested this assumption using monthly return data for NYSE common stocks between January 1926 and December 1982. Their findings also revealed that most of the excess returns, consistent with prior research on the turn-of-the-year effect and seasonality, are obtained in January.

Later, Lakonishok and Smidt [11] took into account the daily closing prices of the Dow Jones Industrial Average from 1897 to 1986 in order to test if there is a permanent seasonal pattern in the rates of return. Their study raises evidence that along the 90 years taken into account returns are constantly anomalous at the turn of the week, month, year and around holidays.

Haug and Hirschey [8] claim that small firms continue to register abnormally high returns over time and the Tax Reform Act of 1986 (in US) didn't have any effect on their stock capitalization. Furthermore, the individual tax loss-selling hypothesis and behavioural explanations should be taken more into account. Also, the window-

dressings hypothesis is suggested as possible explanation for the positive return premiums in January. Usually, the end of the year is an important reporting period, so investors would seek to exhibit an attractive portfolio by eliminating embarrassing losers.

Reinganum [12] discovered that the January effect is more visible for those small companies that during the other eleven months have negative annual returns and is insignificant for small-cap "winners".

As a conclusion of Haug and Hirschey [8], the January effect is a small-cap phenomenon which is still being present in the stock market returns, with emphasize on equal-weighted returns. A general satisfactory explanation wasn't found yet, but the window-dressing, the tax motivated-selling or another anomalous behaviour of investors stand for possible responses for what we call the January effect.

### 3. Data and methodology

In order to test for the January effect on the Romanian capital market we use the BET<sup>1</sup> index from January 2000 to March 2014 and a dummy variable to capture this effect.

Analyzing BET's evolution, one can see that three main sub periods can be identified: starting from January 2000 to September 2007 a period of smooth, but constant growth (the value was 460.67 in the 5<sup>th</sup> of January 2000) up to a maximum of 10 455.62 in July 2007, just before the financial crisis; a second period from September 2007 to 2011 that corresponds to the depression times when BET heavily decreased due to the shocks on the market and the post-crisis period after the end of 2011 which continues nowadays also, when the index has a more volatile character, still being on a growing trend.

To describe the January effect we have chosen to use a dummy variable, meant to ease the analysis. Dummy variables are also known as 'on' 'off' variables or 'switches'

1

BET is a free float weighted capitalization index of the most liquid 10 companies listed on the Bucharest Stock Exchange (BSE) regulated market.

because they can turn on or off different parameters in an equation. Following Keim [10], respectively Lakonishok & Smidt [11], the present study considers variable:

$$d_{jan} = \begin{cases} 1 & \text{for all the days from January} \\ 0 & \text{for the days included in the} \\ & \text{other months} \end{cases}$$

Acc<sub>t</sub> abnormal return is recorded in the first month of the calendar year and this effect is observed mostly in the case of small-sized enterprises [10]. To test the presence of those abnormal returns on the Romanian market, we created a return variable called bet<sub>rt</sub>, where:

$$bet_{rt} = [bet - bet_{(t-1)}] / bet_{(t-1)} \quad (1)$$

The return variable was tested for stationarity using Augmented Dickey-Fuller, Dickey-Fullers GLS (ERS) and Phillips-Perron tests to avoid spurious results.

The market is said to have a 'memory' and there are investors that base their future decisions on past performance of a certain security. By studying the Standard & Poor 500 daily closing price index from 1928 to 1991, some positive autocorrelation was to be seen for large periods of time between market returns. After transforming S&P 500 returns into absolute ones and examining them in respect to the sample autocorrelations, it can be stated that the capital market has a long-term memory [5]. This is important because players on capital markets will always try to predict their future returns.

Considering all these, we built a general model that includes the past and present values of bet return variable and the January dummy variable, as follows:

$$bet_{rt} = c + \beta_1 \times bet_{r(t-1)} + \beta_2 \times bet_{r(t-2)} + \dots + \beta_n \times bet_{r(t-n)} + \alpha \times d_{jan} + \varepsilon_t \quad (2)$$

- c – intercept
- bet<sub>r</sub> – BET return
- d<sub>jan</sub> – the dummy variable for January effect
- ε<sub>t</sub> – standard error

Testing the influence of previous returns in present return we have noticed that only one day before return has a notable influence in



the present one. The market itself is a 'young' market and it comes easy to admit that only recent events have a major impact over the current stock prices. Further on, the new model which corresponds to our case based on the above findings will be:

$$\text{bet}_{rt} = c + \beta_1 \times \text{bet}_{r(t-1)} + \alpha \times d_{\text{jan}} + \varepsilon_t \quad (3)$$

#### 4. Results

The model is tested both on the whole sample and in the three sub-samples (according the volatility). For the entire sample, as one can see in the next table, the January effect seems to be extremely weak.

Table 1: Values for the entire period of study

Variables	Coefficients
c	0.000600*** (0.000294)
bet <sub>r</sub> (-1)	0.122058*** (0.016698)
d <sub>jan</sub>	0.001907** (0.001001)

Source: author's personal estimations

\* stands for a probability that ranges from 0.1 to 1; \*\* stands for a probability that ranges from 0.05 to 0.1; \*\*\* stands for a probability that ranges from 0 to 0.0; In brackets - standard deviation

The results are somehow predictable since the entire sample include also the crisis period. In times of shocks, crisis itself represents a too important determinant that overwhelms the behavioural ones. Hence, the investors will try to understand what happened and how to deal with the new challenge. But until they reach a common point, there will be a period of high volatility due to the fresh information arrived on the market. Some economic agents will tend to overreact and some to under-react to the news. This, in turn, leads to many deviations from the acknowledged models to be observed.

To overcome this impediment, the entire sample period is divided in three sub-periods (period 1 from 2000 to 2007- before the financial crisis; period 2 from 2007 to 2011 - during the crisis and period 3 from 2011 until

the present days - a post-crisis period) and retested again.

For the first period the results show a statistically significant January effect on the Romanian stock market (see Table 2). This period is characterized by a smooth evolution of the BET index because the progress in macroeconomic stability increased the investors' degree of confidence, hence allowing a higher degree of capital inflows into the region.

Table 2: Values for the first period (2000-2007)

Variables	Coefficients
c	0.000985*** (0.000352)
bet <sub>r</sub> (t-1)	0.176813*** (0.022112)
d <sub>jan</sub>	0.004415*** (0.001236)

Source: author's personal estimations

\* stands for a probability that ranges from 0.1 to 1; \*\* stands for a probability that ranges from 0.05 to 0.1; \*\*\* stands for a probability that ranges from 0 to 0.0; In brackets - standard deviation

In the second period that range between the mid-end of 2007 until 2011, the effects of the financial crisis which hit the world economy can be seen in Romania too. In harsh conditions, the patterns observed during calm time-spans seems not correspond anymore (see Table 3).

Table 3: Values for the second period (2007-2011)

Variables	Coefficients
c	-0.000224* (0.000728)
bet <sub>r</sub> (t-1)	0.058031** (0.031556)
d <sub>jan</sub>	-0.003809* (0.002576)

Source: author's personal estimations

\* stands for a probability that ranges from 0.1 to 1; \*\* stands for a probability that ranges from 0.05 to 0.1; \*\*\* stands for a probability that ranges from 0 to 0.0; In brackets - standard deviation

The last period of study is the one comprised between 2011 and 6<sup>th</sup> of March 2014, considered to be a post-crisis period. The results from the table 4 show a very weak January effect, at a low statistically significance level.

Table 4: Values for the third period (2011-March 2014)

Variables	Coefficients
c	0.000424* (0.000405)
$\beta_{t(t-1)}$	0.153011*** (0.042503)
$d_{jan}$	0.001937* (0.001220)

Source: author's personal estimations

\* stands for a probability that ranges from 0.1 to 1; \*\* stands for a probability that ranges from 0.05 to 0.1; \*\*\* stands for a probability that ranges from 0 to 0.0; In brackets - standard deviation

## 5. Conclusions

It is widely accepted today that capital markets show mainly a weaker form of efficiency, but they are not fully efficient as suggested by early theories. The perfect efficiency is more a utopia because investors won't be always rational as they are human beings and humans are subject to errors. Because of this, deviations from the daily mechanisms that govern stock markets will be observed sooner or later. As a result, anomalies which cannot be explained anymore by theoretical models and frameworks appear. It is in people's nature to have an irrational reaction when dealing with events that never happened before, like out of the blue shocks or wars. Moreover, people's mood is not expected to be the same during a whole year.

Testing January effect in Romania, tests' results show that higher than normal returns are recorded only in peaceful times, when no significant events influence the overall environment. That corresponds to the period comprised in this study between 2000 and 2007. In smooth spans the predictable patterns arise in our country too. But then, when a crisis strikes and affects the world

wide economy, indirectly the Romanian market suffers too as we are part of a global system.

A question that still stands is why the January effect didn't fade away as it is common knowledge for so many years by now. So the topic remains open for future research in order to find more plausible explanations for this abnormal pattern.

## 6. References

- [1] Branch, B., "A tax loss trading rule", *Journal of Business*, 50, 1977, pp. 198-207.
- [2] Burghardt, M., *Retail Investor Sentiment and Behavior*, Gabler Verlag | Springer Fachmedien Wiesbaden GmbH, 2011
- [3] Dimson, E., "Risk measurement when shares are subject to infrequent trading", *Journal of Financial Economics*, 7, 1979, pp.197-216.
- [4] De Bondt, W.F.M., Thaler, R., "Does the stock market overreact?", *The Journal of Finance* 40, 1985, pp. 793-805.
- [5] Ding, Z., Granger, C. W.J., Engle, R. F., "A long memory property of stock market returns and a new model", *Journal of Empirical Finance*, 1, 1993, pp.83-106.
- [6] Fama, E. F., "Efficient Capital Markets: A review of theory and empirical work", *The Journal of Finance*, 25, 1970, pp.383-417.
- [7] Fama, E. F., "Efficient Capital Markets: II", *The Journal of Finance* Volume 46, 1991, pp.1575-1617
- [8] Haug, M., Hirschey, M., "The January Effect", *Financial Analysts Journal*, 62, 2006, pp. 78-88.
- [9] Keynes, J.M., *The General Theory of Employment, Interest and Money*. London: Harcourt Brace Jovanovich. 1964 - reprint of the 1936 edition
- [10] Keim, D.B., "Size-related anomalies and stock return seasonality". *Journal of Financial Economics*, 12, 1982, pp. 13-32.
- [11] Lakonishok, J., Smidt, S., "Are Seasonal Anomalies Real?" *The Review of Financial Studies*, 1, 1988, pp.403-42.
- [12] Reinganum, M.R., "The Anomalous Stock Market Behavior of Small Firms in January: Empirical Tests for Tax-loss Selling Effects", *Journal of Financial Economics*, 1983, pp.89-104.
- [13] Roll, R., "A possible explanation of the small firm effect.", *Journal of Finance*, 36, 1981, pp.879-888.
- [14] Scholes, M., Williams, J., "Estimating betas from nonsynchronous data". *Journal of Financial Economics*, 5, 1977, pp.309-327.

- [15]Wachtel, S.B., "Certain observations on seasonal movements in stock prices".  
*Journal of Business*, 15, 1942, pp.184-193.

## Holiday Effect in Contemporary Capital Markets

Aurora Murgea

*West University of Timisoara, Faculty of  
Economics and Business Administration*

[aurora.murgea@e-uvt.ro](mailto:aurora.murgea@e-uvt.ro)

### Abstract

*The prediction of the future capital market evolution is one of the important goals in theory and practice. Anomaly based strategies developed in the last decades of this century represent a more realistic approach to the alternatives based on Efficient Market Hypothesis, since the almost perfect efficient market as the one described by it is hardly to be found in real world. This paper analyzes one of the capital market anomalies, holiday effect in six different capital markets (both as localization and development degree). Despite some weak forms of evidences regarding the presence of this effect in four of the six countries from the sample, a more statistically significant correlation can be seen in Romania case.*

**Key words:** capital market efficiency, anomaly, holiday, return

**J.E.L. classification:** C2, G14, G17

### 1. Efficient market Hypothesis and anomaly based strategies

Despite the fact that nowadays the latest financial crises and several studies contradict the Efficient Market Hypothesis (EMH) a large part of the portfolio management models are still based on it. The efficiency concept was introduced at the final of the 60's by Eugene Fama[22] in a period when the inefficiency was widely accepted both among scholars and practitioners. An efficient market was considered the one where the prices quickly adapt as an effect of the newest available information and fully reflect them [22]. There are no transaction costs, information is available for free to all the players in the market and besides, they are all rational economic agents.

As a base for an overview of the markets at that time, Fama's hypothesis of efficiency opened the doors for positive capital market research. More and more economists started to argue against this theory based on empirical findings. Many anomalies like Monday effect, Weekend effect, pre-holiday return or January effect come to contradict the efficient market theory. The anomalies represent patterns in securities returns which do not fit with any accepted theory or hypothesis. According to Tversky and Kahneman [36] "an anomaly is a deviation from the presently accepted paradigms that is too widespread to be ignored, too systematic to be dismissed as random error, and too fundamental to be accommodated by relaxing the normative system".

The existence of anomalous price behavior proves the market informational inefficiency. Even Fama after 20 years of researches turns back at this theory and admits that pure market efficiency should be seen more as a benchmark for determining which fair information and trading costs are rather than a real world possibility. Using an asset-pricing model, Fama [23] reviews his earlier theory and states that before testing if information is properly reflected in prices or not, you must define firstly what "properly" means. Then, even after completing this task, it will still be hard enough to determine whether the anomaly found on the returns' behavior it is a matter of market inefficiency or a bad model of market equilibrium.

Several categories of anomalies have been documented on the capital markets: *calendar anomalies* as January effect [33], weekend effect [24], Halloween Effect [9] or turn-of-the-month effect [2]; *fundamental anomalies* as value effect [6],[7],[15],[16], size and neglected firms effect [5],[1], financial reports effect [4]; *technical anomalies mood anomalies* determined by the weather parameters: number of hours of sunshine,

temperature, humidity, geomagnetic storms [34],[10],[19],[20] and by biorhythm variables: full moon effect [17], Daylight Saving Time (DST) effect [25],[27], SAD effect [26],[18].

The presence and persistence of abnormal patterns in stock returns are very important for investors, since they could be used to build anomaly-based trading strategy. The intensity of the anomalies appears to be higher for the capital markets that are not very well developed, where weak regulatory system, slow progresses on private sector development, the limited supply of institutional investors and macroeconomic uncertainty, represent serious obstacles to stock market development. For the countries situated on the opposite side, that have highly liquid and more efficient capital markets, recent studies have proved that the presence of capital market anomalies have been attenuated since they are already known [35] and they can be offset by traders' strategies [13].

The aim of this paper is to analyze one of the most important capital market anomalies, holiday effect using six major indices: BET10 (Bucharest Exchange Trading), DAX (Deutscher Aktienindex), CAC40 (Cotation Assistée en Continu 40), RTS (Russia Trading System) , ATHEX and S&P500 (Standard & Poor's 500).The paper is structured in four parts. The second section presents the major findings in this area, the third section include data and methodology and the last tone concludes.

## 2. Holiday euphoria and capital markets

An unusual large return prior market holidays was first documented by Ariel (1990) who pointed out that one day prior to holidays mean stock returns averages nine to fourteen times the mean returns in the remaining days of the year. Also he noticed that over a third from the return accrued by a portfolio during the period 1963-1982 comes from eight trading days, all situated before holiday market closings.

Lakonishok and Smidt [29] in a similar study found abnormal return not only in the each two pre-holiday trading days but also for the inter-holiday period even if those returns does not equal the exceptionally high returns from the two pre-holiday days.

There are several potential explanations for this phenomenon. One of the explanations assume that pre-holiday returns are just another type of return abnormalities around trading halts, similar with the ones that appear in day-of- the –week effect. But, one could notice that there are important differences. First, comparing with Mondays when the markets experience a decreased return, the day after holidays does not show similar pattern. Plus the abnormal return in pre-holiday period average two to five times the Friday abnormal returns which suggest that holiday effect is could have some other potential causes except the trading halt.

Another explanation connects with holiday euphoria and an increased buying pressure as a result of a more relaxed attitude towards risk in pre-holiday period. A more positive view regarding the future associated with the holiday mood determines an increased willingness to bear risk and to buy new shares.

Several later other studies have found the abnormal pre and inter-holiday returns in different countries and continents. The main studies are shortly presented in the next table:

*Table.1. Literature synthesis*

Year	Authors	Main findings
1994	Kim and Park[28]	Identified abnormally high returns in the trading day before holidays in UK, Japanese market and three major markets in US: NYSE, AMEX, RASDAQ
1996	Chan, Khanthavit and Thomas[12]	Tested holiday effect in Kuala Lumpur Stock Exchange, The Stock Exchange Bombay, The Stock Exchange of Singapore and the Stock Exchange of Thailand and noticed that cultural holidays had a stronger effect that state holidays in Singapore and Kuala Lumpur
1999	Mookerjee and Yu[32]	Valuated the Shanghai and

		Shenzhen markets and found a positive holiday effect
2002	Coutts and Sheikh[14]	Opposite with previous findings the authors does not find any pre-holiday effect in the All Gold Index returns on the Johannesburg Stock Exchange due to particular market microstructure of this market.
2009	Marrett and Worthington[31]	Examines the effect in Australia, both at the market aggregate level and an at the industry level. The main conclusion that arise is that there is a pre-holiday effect on the Australian market ,result of a strong pre-holiday effect in the retail industry
2010	Dzhabarov and Ziemba[21]	Proved that despite the more turbulent nature of the capital markets in the early part of the 21 <sup>st</sup> century, the holiday effect still exist especially in the case of small caps. The study uses Russell 2000 Index for small caps and S&P500 Index for large caps.
2012	Bialkowski, Etebari, Wisniewski[8]	Significantly higher and less volatile returns are found to be present during the Ramadan for 14 predominant Muslim countries
2013	Casado, Muga and Santamaria[11]	Proved that US holidays impact not only on American markets but also on the European's ones
2014	Marques[30]	Founded the effect in six largest American stock markets

### 3. Data and methodology

Main data used to test the presence and intensity of holiday effect was daily closing prices for six major European and American indices: BET10 (Bucharest Exchange Trading), DAX (Deutscher Aktienindex), CAC40 (Cotation Assistée en Continu 40), RTS (Russia Trading System) , ATHEX and S&P500 (Standard & Poor's 500).The analysis period starts in 31<sup>st</sup> of October 2000 to 31<sup>st</sup> of march 2015 and it is long enough to capture several return determinants.

Based on daily closing prices daily returns were compounded for each index using the general formula written bellow:

$$R_i = (P_i - P_{i-1}) / P_{i-1} \quad (1)$$

where:

$R_i$  – daily return for de index  $i$

$P_i$  –daily closing price for the index  $i$

The return variable was tested for stationarity using Augmented Dickey-Fuller, Dickey-Fullers GLS (ERS) and Phillips-Perron tests to avoid spurious results.

To capture holiday effect a set of dummy variables, built using each country specific holidays is used:. Dummy variable takes the next values:

$$\begin{cases} - 1 & \text{one trading day before the holiday day} \\ - 0 & \text{otherwise} \end{cases}$$

For each country have been considered the next holidays:

*Table 2. Holidays considered in the study*

<b>Romania</b>
<b>New Year's Eve</b> – 31 <sup>st</sup> of December
<b>Easter</b> –specific date each in April or May
<b>Labor day</b> - 1 <sup>st</sup> of May
<b>The Whitsuntide</b> - the 50 <sup>th</sup> day after Easter-
<b>The Dormition of the Mother of God</b> – 15 <sup>th</sup> of August
<b>Saint Andrew</b> - 30 <sup>th</sup> of November
<b>National day</b> -1 <sup>st</sup> of December
<b>Christmas</b> – 24 <sup>th</sup> of December
<b>Germany</b>

<p><b>New Year's Eve</b> - 31<sup>st</sup> of December  <b>The three magi</b> -6<sup>th</sup> of January  <b>Easter</b> –specific date each in April or May  <b>Labor day</b> - 1<sup>st</sup> of May  <b>The Dormition of the Mother of God</b> – 15<sup>th</sup> of August  <b>Germany unification day</b> -3<sup>rd</sup> of October  <b>Reformation day</b> -31<sup>st</sup> of October  <b>All saint's day</b> -1<sup>st</sup> of November  <b>Christmas</b> – 24<sup>th</sup> of December  <b>Saint Sylvester</b> -31<sup>st</sup> of December</p>
<b>France</b>
<p><b>New Year's Eve</b> - 31<sup>st</sup> of December  <b>Easter</b> –specific date each in April or May  <b>Labor day</b> - 1<sup>st</sup> of May  <b>Victory Day</b> -8<sup>th</sup> of May  <b>National Day</b> -14<sup>th</sup> of July  <b>The Dormition of the Mother of God</b> – 15<sup>th</sup> of August  <b>Commemoration of All the Faithful Departed</b> – 1<sup>st</sup> of November  <b>1918 Truce Day</b> -11<sup>th</sup> of November  <b>Christmas</b> – 24<sup>th</sup> of December</p>
<b>Russia</b>
<p><b>New Year's Eve</b> – 31<sup>st</sup> of December  <b>Christmas</b> -7<sup>th</sup> of January  <b>The Motherland Defense Day</b> -23<sup>rd</sup> of February  <b>Victory Day</b> -9<sup>th</sup> of May  <b>National day</b> -12<sup>th</sup> of June  <b>The Popularly Unit Day</b> -4<sup>th</sup> of November</p>
<b>Greece</b>
<p><b>New Year's Eve</b> - 31<sup>st</sup> of December  <b>John the Baptist</b>-6<sup>th</sup> of January  <b>Grey Monday</b> -15<sup>th</sup> of February  <b>Independence Day</b> -25<sup>th</sup> of March  <b>Easter</b> –specific date each in April or May  <b>Labor day</b> - 1<sup>st</sup> of May  <b>The Whitsuntide</b> - the 50<sup>th</sup> day after Easter-  <b>The Dormition of the Mother of God</b> – 15<sup>th</sup> of August  <b>National day of Greece</b>-28<sup>th</sup> of October  <b>Christmas</b> – 24<sup>th</sup> of December</p>
<b>USA</b>
<p><b>New Year's Eve</b> - 31<sup>st</sup> of December  <b>Martin Luther King, Jr. Day</b> –third Monday of January  <b>Washington president Day</b>- 16<sup>th</sup> of February  <b>Memorial Day</b> -31<sup>st</sup> of May  <b>Independence Day</b>- 4<sup>th</sup> of July  <b>Labor day</b> - 6<sup>th</sup> of September  <b>Columb Day</b> -11<sup>th</sup> of October  <b>Veteran's Day</b> – 1st of November  <b>Thanks Giving</b> -25<sup>th</sup> of November  <b>Christmas</b> – 24<sup>th</sup> of December</p>

Source: author's compilation

In order to capture the holiday effect on the six markets a naïve OLS model is used. Its general form, that has been in the second

step customized for each one of the six indices is presented bellow:

$$R_{i,t} = c + \beta_1 R_{i,t-1} + \beta_2 R_{i,t-2} + \beta_3 R_{i,t-3} + \dots + \beta_n R_{i,t-n} + \alpha d_i + \varepsilon_t \quad (2)$$

where :

c - constant.;  $\beta_1, \dots, \beta_n$ ,  $\alpha$ - importance coefficients of independent variables;  $d_i$ - dummy variable;  $\varepsilon_t$  - standard error

After customization and calibration six models have emerged for the six indices:

$$BETR_t = c + \beta_1 BETR_{(t-1)} + \beta_2 BETR_{(t-5)} + \alpha d_{BETR_t} + \varepsilon_t \quad (3)$$

$$DAXR_t = c + \beta_1 DAXR_{(t-2)} + \beta_2 DAXR_{(t-5)} + \alpha d_{DAX_t} + \varepsilon_t \quad (4)$$

$$CACR_t = c + \beta_1 CACR_{(t-1)} + \beta_2 CACR_{(t-2)} + \beta_3 CACR_{(t-3)} + \alpha d_{CAC_t} + \varepsilon_t \quad (5)$$

$$RTSR_t = c + \beta_1 RTSR_{(t-1)} + \beta_2 RTSR_{(t-3)} + \beta_3 RTSR_{(t-4)} + \beta_4 RTSR_{(t-5)} + \alpha d_{RTS_t} + \varepsilon_t \quad (6)$$

$$ATHEXR_t = c + \beta_1 ATHEXR_{(t-1)} + \beta_2 ATHEXR_{(t-2)} + \beta_3 ATHEXR_{(t-4)} + \beta_4 ATHEXR_{(t-7)} + \alpha d_{ATHEX_t} + \varepsilon_t \quad (7)$$

$$S\&P500R_t = c + \beta_1 S\&P500R_{(t-1)} + \beta_2 S\&P500R_{(t-2)} + \beta_3 S\&P500R_{(t-3)} + \alpha d_{S\&P500_t} + \varepsilon_t \quad (8)$$

#### 4. Main results

Testing the prior benchmarks one could notice that the only index where the returns seems to be statistically significant abnormal around holidays is Romanian BET (see the next table with results)

Table 3. Results on each country

	Variables	Coefficients
Romania	C	0,000803 ** (0,000355)
	BETR(-1)	0,045463 ** (0,018037)
	BETR(-5)	0,077430 *** (018023)
	DUMMY_BET	0,004549 ** (0,002215)
Germany	C	0.000262 (0,000304)
	DAXR(-2)	-0,050853 *** (0,017970)
	DAXR(-5)	-0, 028188 * (0,017969)
	DUMMY_DAX	0,002882 * (0,001648)
Fr an s	C	0.00005 (0.000294)

	CAC40R(-1)	-0,056054 *** (0,018097)
	CAC40R(-2)	-0,054173 *** (0,018092)
	CAC40R(-3)	-0,0554173 *** (0,018092)
	DUMMY_CAC40	0,001345 (0,001504)
Russia	C	0,000668 (0,000441)
	RTSR(-1)	0,054415 *** (0,018041)
	RTSR(-3)	-0,027380 * (0,0017698)
	RTSR(-4)	-0,038650 ** (0,017708)
	RTSR(-5)	0,065060 *** (0,017698)
	DUMMY_RTS	0,004406 * (0,002462)
Greece	C	-0,000431 (0,000371)
	ATHEXR(-1)	0,044837 ** (0,018091)
	ATHEXR(-2)	-0,048159 *** (0,018081)
	ATHEXR(-4)	-0,044308 ** (0,018048)
	ATHEXR(-7)	0,036597 ** (0,018059)
	DUMMY_ATHEX	0,002697 * (0,001863)
USA	C	0,00988 (0,001115)
	SP500R(-1)	-0,119697 *** (0,018090)
	SP500R(-2)	-0,055895 *** (0,018093)
	SP500R(-3)	-0,00000589 (0,0000008)
	DUMM_SP500	0,000846 (0,001267)

Source: author's personal estimations

\* stands for a probability that ranges from 0.1 to 1; \*\* stands for a probability that ranges from 0.05 to 0.1; \*\*\* stands for a probability that ranges from 0 to 0.0; In brackets - standard deviation

## 5. Conclusion

As one can see the only country where the holiday effect seems to be present and statistically significant is Romania. For Germany, Russia and Greece one could notice the presence of the effect but less statistically significant. For France, and USA

there is no evidence of abnormal returns due to the weekend effect.

The results obtained for Romania are quite explainable since Romania capital market is less efficient comparing with all the rest of the countries in the sample. The presence of abnormal returns due to all sorts of calendar anomalies is in this sense easier to be explained but also better to be exploited thought anomaly traded strategies. Those strategies were proven to be less efficient on developed markets where these effects are tempted to disappear sooner after their discovery since the traders are trying to use them for their own benefit and reverse the tend through their strategies.

A further analysis may distinguish among religious and cultural holidays to be able to analyze if there are differences among the effect their produce.

## 6. References

- [1] Abel,A. , Strebel,P.,“The neglected and small firm effects”, *The Financial Review* (November) 1982, pp. 201-218.
- [2] Ariel,R.A., “A monthly effect in stock returns”, *Journal of Financial Economics*, 18, 1987, pp.161-174.
- [3] Ariel, R.A., “High Stock Returns before Holidays; Existence and Evidence on possible causes”, *Journal of Finance*, 45, 1990, pp.1611-1626
- [4] Ball, R., Brown, P. “An empirical evaluation of accounting numbers”, *Journal of Accounting Research*, 6, 1968, pp.159-178.
- [5] Banz, R. “The Relationship Between Return and Market Value of Common Stock”, *Journal of Financial Economics*, 9, 1981, pp.3-18.
- [6] Basu,S. “Investment Performance of Common Stocks in Relation to Their Price-Earnings Ratios: A test of the Efficient Markets Hypothesis”, *Journal of Finance*, 32, 1977, pp.663-682.
- [7] Basu, S., “The Relationship between Earnings' Yield, Market Value and Return for NYSE Common Stocks: Further Evidence”, *Journal of Financial Economics*, 12, 1983, pp.129-156.
- [8] Bialkowski,J., Etebari, A., Wisniewski,T.P., “Fast profits: investor sentiment and stock returns during Ramadan”, *Journal of Banking and Finance*, 36, 2012, pp.835-845
- [9] Bouman, S. ,Jacobsen, B. “The Halloween Indicator, ‘Sell in May and Go Away: Another; Another Puzzle”, *American Economic Review*, 92, 2002, pp. 1618-1635.



- [10] Cao, M., Wei, J. "Stock market returns: a note on temperature anomaly". *Journal of Banking and Finance*, 29, 2005, pp.1559-1573.
- [11] Casado, J., Muga, L., Santamaria, R., "The effect of US holiday on the Europe markets: when the cat's away...", *Accounting & Finance*, 53, 2013, pp.111-136
- [12] Chan, M.W.L., Khanthavit, A., Thomas, H., "Seasonality and cultural influences on four asian stock markets", *Asia Pacific Journal of Management*, 13, 1996, pp.1-24
- [13] Chordia, T., Subrahmanyam, A., Tong, Q. "Have capital market anomalies attenuated in recent era of high liquidity and trading activity?", *Journal of Accounting and Economics*, 58, pp.2014, pp.41-58.
- [14] Coutts, J.A., Sheikh, M.A, "The anomalies that aren't there: the weekend, January and pre-holiday effects on the all gold index on the Johannesburg Stock Exchange 1987-1997", *Applied Financial Economics*, 12, 2002, pp.863-871
- [15] DeBondt, W. F. M. , Thaler, R. H. "Does the stock market overreact", *Journal of Finance*, 40, 1985, pp. 793-805.
- [16] DeBondt, W. F. M., Thaler, Richard H., "Further evidence on investor overreaction and stock market seasonality", *Journal of Finance* 42, 1987, pp.557-581.
- [17] Dichev, I.D., Janes, T.D., "Lunar cycle effects in stock returns", *Journal of Private Equity*, 6, 2003, pp. 8-29.
- [18] Dowling, M., Lucey, B.M., "Weather, biorhythms, beliefs and stock returns – Some preliminary Irish evidence", *International Review of Financial Analysis*, 14, 2005, pp. 337-355.
- [19] Dowling, M, Lucey, B.M. "Mood and UK equity pricing", *Applied Financial Economics Letters*, 4, 2008a, pp.233 – 240.
- [20] Dowling, M, Lucey, B.M. "Robust global mood influences in equity pricing", *Journal of Multinational Financial Management*, 18, 2008b, pp.145-164.
- [21] Dzhabarov, C., Ziemba, W.T., "Do seasonal Anomalies still work?" *The Journal of Portfolio Management*, 36, 2010, pp.93-104.
- [22] Fama, E. F. , "Efficient Capital Markets: A review of theory and empirical work", *The Journal of Finance*, 25, 1970, pp.383–417.
- [23] Fama, E.F., "Efficient markets II", *Journal of Finance* 46, 1991, pp.1575-1617
- [24] French, K., "Stock returns and the weekend effect", *Journal of Financial Economics*, 8, 1980, pp. 59-69.
- [25] Kamstra, M.J., Kramer, L.A., Levi, M.D., "Losing sleep at the market: The Daylight Saving Anomaly", *The American Economic Review*, 90, 2000, pp. 1005-1011.
- [26] Kamstra, M.J., Kramer, L.A., Levi, M.D., "Winter blues: a SAD Stock market cycle". *The American Economic Review*, 93, 2003, pp. 324-343.
- [27] Kamstra, M.J., Kramer, L.A., Levi, M.D., "Loosing sleep at the market: the Daylight Saving Anomaly: Reply", *The American Economic Review*, 92, 2002, pp.1257-1263.
- [28] Kim, C.-W., Park, J., " Holiday Effects and Stock Returns: further evidence, *Journal of Financial and Quantitative Analysis*, 1, 1994, pp.145-157
- [29] Lakonishok, J., Smidt, S. "Are seasonal anomalies real? A ninety year perspective" *The Review of Financial Studies*, 1, 1988, pp.403-425
- [30] Marques, A.L.M., " Public holiday and weekend anomalies in main Latin American stock markets", *Latin American Business Review*, 15, 2014, pp.123-139
- [31] Marrett, G.J., Worthington, A.C., "An empirical note on the holiday effect in the Australian stock market, 1996–2006", *Applied Economics Letters*, 16, 2009, pp.1769-1772
- [32] Mookerjee, R., Yu, Q., "An empirical analysis of the equity markets in China", *Review of Financial Economics*, 8, 1999, pp.41-60
- [33] Rozeff, M. S., Kinney, W. R. "Capital Market Seasonality: The Case of Stock Returns", *Journal of Financial Economics*, 3(4), 1976, pp.379-402
- [34] Saunders, E.M. "Stock prices and Wall Street weather", *The American Economic Review*, 83, 1993, pp.1337-1345.
- [35] Schwert, W. G. , "Anomalies and Market Efficiency". In G.M.Constantinides, M.Harris, & R.M.Stultz (Ed.) *Handbook of the Economics of Finance, 1(B)*, Elsevier North Holland, 2003, pp. 939-974
- [36] Twersky, A., Kahneman, D., "Rational choice and the framing of decision", *The Journal of Business*, 59, 1986, pp.251-278.

# Methodology on the Classification of Guarantees, the Establishment, Regulation and use of Risk Provisions for S.M.E. Loan Guarantees

Dumitru Nancu  
„Ovidius” University of Constanta  
[nancu\\_dumitru@yahoo.com](mailto:nancu_dumitru@yahoo.com)

## Abstract

*The main amendment to the current methodology on provisions is represented by the reduction in the Fund's exposure, stemming from the payments of guarantees only based on the debtors' accessory guarantees registered in the Fund's accounting and not based on the calculation estimated on the value of the accessory guarantees due to the Fund or on a historical recovery rate of paid guarantees. This paper aims to conduct an analysis in this direction.*

**Key words:** guarantees , risk, operational risks, provisioning methodology

**J.E.L. Classification:** O 16

## 1. Introduction

The National Bank of Romania requested an amendment by the end of 2015 of the methodology for provisioning the payments made by the Fund, namely the possibility that, upon the calculation of the necessary specific risk guarantee provisions, the guarantees made by SMEs in order to complete the Fund guarantee should be deducted only if these accessory guarantees are registered in the Fund's accounting for each guaranteed loan.[1]

According to NBR, the value of the debtors' accessory guarantees, which complete the guarantee granted by the Fund in order to access bank funding, should be registered in the accounting, in order to deduct them upon the establishment of the specific risk guarantee provisions.[2]

## 2. The main amendments to the methodology for calculating the specific risk guarantee provisions

In order to record the value of guarantees in the accounting, the Fund shall request annually to Funders the assessed updated value of accessory guarantees, their value approved under guarantee and the last assessment date for the entire portfolio of paid guarantees, unrecovered fully and covered by the risk-sharing principle.

Based on the data received from Funders, the National Credit Guarantee Fund for Small and Medium Enterprises (abbreviated as FNGCMM in Romanian) adjusts the Fund's exposure from the guarantees paid by the accessory guarantees, as follows:[3]

- i. **For the paid contracts of guarantee that do not benefit from the risk-sharing clause**, given that the Fund may not require amounts from the recoveries made by Funders, the value of the collateral guarantees due to the Fund shall be 0. Therefore, the values of the debtor's collateral guarantees shall not be registered in the Fund's accounting and the constituted guarantee provision shall be 100% of the net exposure, where the net exposure is equal to the performed payments minus the recoveries collected.
- ii. **For the paid contracts benefiting from the risk-sharing clause**, the approved value of the debtors' complementary guarantees is established as follows:

- The amount of the accessory guarantee due to the Fund that decreases the exposure from the guarantees paid in order to constitute the specific guarantee provision for each contract of guarantee is determined based on the guarantee and counter-guarantee percentage applied to the approved guarantee value communicated by the Funder. It is noteworthy that the adjustment of the accessory guarantee value with the

counter-guarantee percentage shall be achieved only for the contracts of guarantee wherefore there were collected amounts from the RCF (Romanian Counter-Guarantee Fund), representing the related counter-guarantee.

- The approved guarantee value that resulted above is weighted with the maximum adjustment coefficient of 25% set by the NBR Regulation no. 5/2012 on the establishment of the specific provisions by NBFIs (Non-Bank Financial Institutions) for the exposures situated in the category *loss* (guarantees paid by the Fund), resulting in the value of the guarantees which decrease the Fund's exposure.

- The formulas resulting from the judgments above are:

1. For non-counter-guaranteeing contracts of guarantee and for contracts of guarantee wherefore amounts representing related counter-guarantees were not collected from the RCF:

**Diminishing exposure value (based on accessory guarantees) = approved guarantee value x (% Guarantee)**

2. For contracts of guarantee wherefore amounts representing related counter-guarantees were charged from FRC:

**Diminishing exposure value (based on accessory guarantees) = approved guarantee value x (% Guarantee) X (1-% Counter-guarantee)**

3. For the contracts above, the value of the specific guarantee provision is calculated using the following formula:

**Specific guarantee provision = Net exposure - 25% x Diminishing exposure value**

### **3. Types of accessory guarantees which reduce the Fund's exposure from paid guarantees and adjust the level of the specific risk guarantee provisions**

The accessory guarantees eligible for the decrease in exposure from paid guarantees are:

- Mortgages;
- Equipment;
- Machinery;
- Inventories;
- Claims;

- Other movable securities;
- Deposits (cash collateral);
- Guarantees issued by other guarantee funds;
- Trust letters issued by other financial institutions.

The classification of an accessory guarantee in the categories above is made in the Charisma management system. In determining the above list of accessory guarantees, there were taken into account the provisions of Regulation 5/2012, Appendix 2 (detailing the guarantees issued by guarantee funds and those issued by financial institutions, among the types of guarantees that can reduce exposures in order to form provisions) and other provisions of the same regulation providing for the admission of other real securities in accordance with the internal rules of each creditor. As far as the category of other guarantees recorded in Charisma is concerned, the mortgages on the beneficiaries' current account were not taken into consideration.

The coverage rate of net guarantee payments by specific provisions should reflect, with a high degree of trust, the likelihood that the Fund shall recover the paid guarantees based on accessory guarantees; for this purpose, we proposed that all real guarantees should be accepted only if their reassessment were carried out by Funders, within reasonable time, from the date establishing the necessary provisions, as follows:

*Tab. no. 1 - Type of accessory guarantees*

Type of accessory guarantees	The maximum seniority of the assessment/ reassessment date compared to the reference date
Mortgages	36 months
Equipment	24 months
Machinery	24 months
Claims	18 months
Other movable securities	18 months
Inventories	12 months
Deposits	The criterion of seniority reassessment is not applicable
Guarantees issued by other	The criterion of seniority

guarantee funds	reassessment is not applicable
Trust letters issued by other financial institutions	The criterion of seniority reassessment is not applicable

It is noteworthy that the eligibility of the accessory guarantees depending on their assessment seniority reduces the risk for the Fund, when the annual request to Funders to update the accessory guarantees is sent and the Funders do not send these revaluations or send them late. Thus, regardless of when the Funders send the annual reassessments of the accessories guarantees, the latter may be eligible in terms of the reduction of the exposures from guarantee payments if they meet the above criteria of seniority.[4]

Following the application of the formulas for calculating the specific risk guarantee provisions, the general level of coverage with specific provisions of all net disbursements is estimated to reach a value of 98% on 31<sup>st</sup> December 2015, while the level of coverage with specific provisions of all net disbursements, to which the risk-sharing principle is applied (and wherefore accessory guarantees for the loan guaranteed by the Fund were taken into consideration, in order to reduce exposure, in view of establishing specific provisions) is estimated to reach a value of 96%.

At the Fund level, updated information on the values approved as guarantees by the Funders of accessory guarantees has not been collected yet; consequently, the amounts recovered by the paid guarantees were allocated only to the paid contracts of guarantee, without being reconciled with the accessory guarantees executed by funders. Thus, it is not possible to test the historic recovery rate at the level of accessory guarantees; we can test it only on the entire portfolio of disbursements. [5]

We proceeded to test the historical annual recovery rate of the portfolio of paid guarantees by relating the annual volume of recoveries within one year to the net guarantee payments from the beginning of that year; the results are shown in the table below:

Tab. no. 2 - Historical annual recovery rate of the portfolio of paid guarantees

Year of recovery	Total recovery rate	
	Total portfolio payments	Total portfolio payments to which the risk sharing principle is applied
2010	2,2%	Not applied
2011	0,3%	0,5%
2012	1,8%	4,1%
2013	0,7%	0,8%
2014	2,3%	4,4%
2015 (January – November)	1,8%	2,9%

Source: FNGCIMM Reports

The method of calculating the recovery indicator in the table above did not take into account the recoveries made during one year, in certain contracts of guarantee, paid in the same year.

The data in the table above indicate that, within reasonable time, the proposed rule for the establishment of specific provisions provides for the convergence of the coverage rate with provisions of the net disbursements performed to the real recovery rate.

#### 4. The impact of the implementation of the new methodological rules on guarantee risk provisions

Following the simulations based the portfolio of the guarantees paid by the end of August, and given the updated values of the guarantees transmitted by Funders, it resulted, applying the above criteria, that it is necessary to increase the demand for specific risk guarantee provisions (increasing the provision expenses) by 16,054,678 RON.

This impact was calculated for the entire portfolio of guarantee contracts for which there were set up specific risk guarantee provisions on 31<sup>st</sup> August 2015.

After sending letters to banks, during September 2015, requesting updates on accessory guarantees, 772 contracts of guarantee were updated, presented in THE below tabel. It is noteworthy that for 428 contracts of guarantee without the *pari-passu* clause, there were not sent letters to funders requesting to update the amount of accessory guarantees. Also, for 381 contracts of

guarantee, to which the principle of *pari-passu* applies, the banks were not required to update the accessory guarantees because, in the Charisma management system, they benefitted from guarantees which did not reduce the risk (mortgages on current accounts). For 45 paid contracts of guarantee, the funders did not send any updates on accessory guarantees.

*Tab. no. 3 – Updated contracts of guarantees*

	No. of contracts	Net disbursements	Specific provisions
Contracts with updated accessory guarantees	772	251.332.803	228.649.166
Contracts without updated accessory guarantees, of which:	<b>854</b>	<b>263.514.256</b>	<b>256.824.507</b>
Contracts with <i>pari-passu</i>	426	34.813.050	32.709.517
Contracts without <i>pari-passu</i>	428	228.701.206	224.114.991
<b>Total</b>	<b>1.626</b>	<b>514.847.058</b>	<b>485.473.673</b>

*Source: FNGCIMM Reports*

In the table above, the *pari-passu* contracts of guarantee, without updated accessory guarantees, are represented mostly by contracts of guarantee with mortgages on the beneficiary's current account (issued in favor of Banca Transilvania).

The contracts of guarantee without updated accessory guarantees, presented in the above table, generate an immediate expense of specific risk guarantee provisions in the amount of 6,708,708 RON.

The contracts of guarantee for which updates were received from banks generate an expense of specific risk guarantee provisions in the amount of 9,345,970 RON, incurred according to the eligibility criteria of accessory guarantees (typology, the maximum assessment seniority) defined under the following note:

*Tab. no. 4 - The impact of the application of the proposed provisioning rule on the contracts of guarantee for which there were received updates on the value of the accessory guarantees from funders*

Indicator	Value
No. of contracts for which there were received updates from banks	772
Net payments	251.332.803
Current provisions	228.649.166
Guarantees admitted in guarantee by bank	148.910.744
Guarantees due to FNGCIMM (bank guarantees adjusted by % Guarantee)	62.295.823
Final guarantees due to FNGCIMM (after the adjustment by % Guarantee and % counter-guarantee)	53.350.666
Provisions to be established	237.995.136
Increase of the provision expense	9.345.970

*Source: FNGCIMM Reports*

In the above table, the calculation of necessary provisions is made after performing the deduction of 25% (It represents the adjustment coefficient imposed by the NBR to the exposures from the category *loss*, under Regulation 5/2012, for the establishment of specific provisions for NBF.I.) of the guarantees due to FNGCIMM, after the adjustment of the admitted guarantees by banks with the guarantee and the counter-guarantee percentage.

The guarantees due to FNGCIMM in the above table are the following:

*Tab. no. 5. - Guarantees due to FNGCIMM*

Type of accessory guarantee	Values approved by banks	Value due to FNGCIMM (adjusted by % guarantee)	Value due to FNGCIMM (adjusted by % guarantee and % counter-guarantee)
MORTGAGE	140.000.664	57.215.061	48.777.320
MACHINERY	3.808.012	2.310.952	1.984.249
EQUIPMENT	3.396.419	1.751.304	1.575.614
OTHER ESTATES	1.054.706	525.462	524.742
DEPOSITS	354.955	277.077	277.077

INVENTORY	208.989	146.366	142.063
CLAIMS	87.000	69.600	69.600
<b>TOTAL</b>	<b>148.910.745</b>	<b>62.295.822</b>	<b>53.350.666</b>

Source: FNGCIMM Reports

## 5. Conclusions

The main risks and the operational challenges that will arise following the entry into force of the new methodology for the specific risk guarantee provisions:

- FNGCIMM does not expect, for the guarantees paid within a month, to receive updates from funders on the accessory guarantees by the end of the same month. In this case, these payments will be provisioned at a rate of 100% at the end of the month when the payment was performed; afterwards, any revenues from provisions (on average, about 4% of the disbursements) shall be recorded when the funder - beneficiary of the disbursements – sends to the Fund data in order to update the value of accessory guarantees. We estimate that this situation will not have a significant impact on the monthly regularization of the specific risk guarantee provisions.

- At this moment, in FNGCIMM, there is no automatic system for the reconciliation of the performed guarantee recoveries with the type of the accessory guarantee which was executed in order to achieve these recoveries; this is also due to the fact that, besides the guarantee recoveries arising from the execution of accessory guarantees, there are also guarantee recoveries based on the investment of the personal fidejussion of SMEs managers. Therefore, there is the risk that an accessory guarantee may reduce the exposure from the paid guarantees, if the former had been already executed by the funder and the amounts resulting from the execution had been transferred to FNGCIMM. Since the amount of the recoveries made by the Fund based on accessory guarantees is low, the impact will be insignificant. Moreover, given that up to 30 September, each year, FNGCIMM asks funders to update the value approved in warranty to accessory guarantees, the annual financial statements concluded at the end of each year can be affected by this risk in an insignificant manner. It is noteworthy that there will be settled later, in a separate

procedure, the workflow for registering the amounts from executing the guarantees in connection with the contracts of guarantee and the related collateral guarantees.

## 6. References

- [1] Raportul Anual BNR 2014, [www.bnr.ro](http://www.bnr.ro)
- [2] Raport asupra stabilității financiare 2015, [www.bnr.ro](http://www.bnr.ro)
- [3] *Buletinul Fondului Roman de Contragarantare nr 1 (2011/2012/2013)*, EDITOR: S.C. "Tribuna economica" – S.A.
- [4] Unconventional monetary policies and financial stability: implications for banks and financial markets (2015) - *Mugur Isărescu, guvernatorul BNR*
- [5] AUDITUL FONDULUI DE GARANTARE PENTRU IMM-URI, 2011, Luxemburg: Oficiul pentru Publicații al Uniunii Europene.

# The impact of Implementing a New Rating System for the Framework Covenant on the Guarantee and Counter-Guarantee Coverage Level for SME Loans on the Access to Finance

Dumitru Nancu  
„Ovidius” University of Constanta  
[nancu\\_dumitru@yahoo.com](mailto:nancu_dumitru@yahoo.com)

## Abstract

*The National Credit Guarantee Fund for Small and Medium Enterprises IFN SA (abbreviated as FNGCIMM SA – IFN in Romanian) was established in December 2001 by GD no. 1211/2001, in order to support the entrepreneurs' activities (SMEs (small and medium enterprises), cooperative enterprises and natural persons authorized to do business under the law in force).*

*As a joint-stock company whose sole shareholder is the Romanian State, represented by the Ministry of Finance, the Fund is a state instrument used in order to implement those policies that support the development of SMEs, which represents a priority of the national economic and social policies.*

*The National Credit Guarantee Fund for Small and Medium Enterprises IFN SA is a financial instrument managed by the Ministry of Public Finances, providing guarantees and counter-guarantees to financial intermediaries, for the loans granted to SMEs by financial institutions, in order to increase the financing offer by the loans granted to SMEs.*

**Key words:** new rating model, Framework Covenant, Guarantee Coverage Level.

**J.E.L. Classification:** O 16

## 1. Introduction

The purpose of the EU Guarantee Fund for SMEs is to provide additional access to credits for these enterprises.

**The sections of the Guarantee Fund for SMEs are:**[1]

- debt financing (loans or leasing);
- microcredit financing;

- guarantees for equity or quasi-equity investments in SMEs and

- SME loan securitization.

Currently, the assessment and classification in risk classes of SME beneficiaries is performed in two ways, depending on the type of the agreement based which the guarantee request is analyzed:

- For coverage level covenants, the risk assessment is performed according to the standard eligibility criteria laid down under each convention concluded with funders;

- For express covenants, risk assessment is carried out by analyzing the financing file sent by funders and the classification in risk classes is performed by calculating a risk score for each beneficiary; this score consists of the following indicators: net worth solvency, receivable rotation ratio, coverage of expenses by the interest on account of the gross operating surplus in the current period under review, the ratio between the annual turnover and the amount of debt for more than a year, the size of the turnover, the share of overdue debts to the state budget in total assets, the ban to the debtor to issue checks and an assessment score of the beneficiary's debt service quality in the Central Credit Register (CCR).

## 2. The need to implement a new rating model for the Framework Covenant on the Guarantee Coverage Level

The main objectives of the new rating system are:[2]

- Introducing the DSCR (debt-service cover ratio) indicator within the rating system, as laid down under the Risk Guarantee Fund policy. This indicator assesses the annual capacity for refunding the credit facilities accessed from funders, paid

at an average interest available in the banking system;

- Using a reduced number of risk information variables, collected from funders, in order to maintain one of the main advantages of the coverage level product - efficiency in terms of a reduced period for the analysis of a guarantee application and the reduction of the time required in order to fill in all the information necessary for the analysis by a banking analyst;

- Maintaining a high degree of risk discrimination within the rating model.

The indicators included in the scoring model for the covenant on the guarantee coverage level are:

- Economic and financial indicators: solvency, DSCR (debt service coverage indicator or debt service coverage ratio), change in turnover, the ratio of the turnover and the debts up to one year and the size of the turnover;

- Indicators of the payment behavior of SME beneficiaries: the presence of insolvency, the great number of promissory note incidents reported to the Payment Incident Bureau (PIB), the bank's prohibition to issue checks and an assessment score of the debt service quality in CCR.

It is noteworthy that other indicators have been tested, such as current liquidity, operation margin, profit rate, change in equity; however, these indicators are not part of the proposed model, because they are no longer relevant in statistical terms although, at individual level, they influence the credit risk, in combination with other indicators.

The proposed scoring function assumes that an enterprise is less risky as the score is lower. The proposed scoring function is:[3][4].

$$\begin{aligned} \text{Score} = & 0,8612 - 0,4545x \text{ Solvency} - \\ & 0,1994x \text{DSCR} - 0,3855x \text{Turnover variation} \\ & - 0,025x \text{ Turnover/ Debt up to one year} + \\ & 0,1779x \text{ Size of the turnover} \\ & + 0,665x \text{Presence of insolvency} + 0,0067x \\ & \text{Number of promissory notes in PIB} \\ & + 1,2007x \text{ Presence of the bank's} \\ & \text{interdiction to issue checks} - 4,4429 x \text{ Debt} \\ & \text{service score, where} \end{aligned}$$

**Solvency** is the ratio between equity and total assets. In order to avoid reporting incorrect values, this indicator is between -1

and 1 (any value less than -1 will enter the model with -1 and any value greater than 1 will enter the model with 1).

**DSCR** is calculated as the ratio between the sum of the operating income, the depreciation expenses and the income taxes based on the annual rates on loans and leases (the rates also include the interest costs). In order to avoid extreme values, any DSCR value less than -1.5 will enter the model with -1.5 and any value greater than 14 will enter the model with 14. The annual rates on loans and leases have been calculated by applying the following rules:

- The line funding does not reimburse the principal

- The credit funding (with amortization) reimburses the principal in equal installments established according to their maturity;

- The interest on line funding is calculated by applying an average interest rate on the entire amount approved to the line;

- The interest on credit funding is calculated by applying an average interest rate taking into account the annual loan repayments;

- The funding due before the analysis date (past due) are fully reimbursed within a year.

**The change in turnover** is calculated by the ratio of the annual turnover and the turnover for the previous financial year. In order to avoid extreme values, any value of this indicator less than 0.4 will enter the model with 0.4 and any value greater than 3 will enter the model with 3.

**Turnover/ debts up to one year** is calculated by dividing the annual turnover to the debts of up to one year. In order to avoid extreme values, any value of this indicator less than 0.032 will enter the model with 0.032 and any value above 21,28 will enter the model with 21,28.

The size of the turnover is a dichotomous variable that takes the value 1 when an enterprise's turnover is higher than 4.5 million RON and 0 otherwise. In essence, the presence of this indicator in the regression model *forces* great enterprises (with a turnover greater than 1 million Euros) to have better indicators than small enterprises.

**The presence of insolvency** is a dichotomous variable that takes the value 1 when the analyzed company is insolvent and 0 otherwise.



**The number of promissory notes in the PIB** is the number of the incidents regarding promissory notes reported to the Payment Incident Bureau (PIB).

**The presence of the bank's prohibition to issue checks** is a dichotomous variable that takes the value 1 when the analyzed company is under a banking ban to issue checks and 0 otherwise.

**The debt service score** has a maximum value of 0.5 when the debt service of the entire beneficiary's used funding reported to CCR is A. Debt service A means a delay of maximum 15 days in the payment of installments, debt service B - a delay between 16 and 30 days, debt service C - a delay between 31 and 60 days, debt service D - a delay between 61 and 90 days.

The formula for calculating the probability of default and the estimation of the proposed score are integrated, representing the combined results of the logistic regression.

This score is calculated using the following formula:

$$\text{Debt service score} = 50\% \times \text{Share of the amounts used in debt service A} + 25\% \times \text{Share of the amounts used in debt service B} + 15\% \times \text{Share of the amounts used in debt service C} + 10\% \times \text{Share of the amounts used in debt service D}.$$

The score function above was developed by using a logistic regression equation, which was also used in order to assess the actual score for the assessment of the guarantees under express covenants. In the literature, this technique has proven its superiority to other econometric estimation techniques, such as *linear discriminant analysis* or *neural networks*. The model was built based on 7,343 beneficiaries in balance on 31<sup>st</sup> December 2011, without payment application, and the default event taken into consideration was represented by the receipt of a payment application within three years (2012 -2014).

For each analyzed application, we will determine the likelihood of requesting the payment of the respective guarantee by the funder over a three-year period, using the following formula.

The formula for calculating the probability of default and the estimation of the proposed score are integrated, representing the combined results of the logistic regression.

**3-year default probability** =  $1/(1 + \exp(-\text{Score}))$ , where  
exp is Euler's constant with an approximate value of 2.718282.

The classification of a guarantee application within a risk class will be achieved by applying the following thresholds to the outcome scores:

*Tab. no. 1 = The classification of a guarantee application within a risk class*

Risk class	Maximum acceptable outcome score (threshold)	3-year default rate
Class I	-4,3829	1,9%
Class II	-3,0233	2,5%
Class III	-2,4576	5,2%
Class IV	-1,6799	10,5%
Class V	-1,0441	24,3%
Class VI	0,3826	43,4%
Class VII	10,4792	70,1%

*Source: FNGCIMM SA Reports*

*Note: Class I is the least risky and Class VII is the riskiest.*

The expected values of default and of the distribution per categories for the guarantee portfolio will be influenced by the following factors:[5]

□ The default rate achieved in the future may differ from the default rate used in order to estimate the model (built in 2012-2014);

□ The financial indicators and the payment behavior indicators of the beneficiary SMEs could be different in the next period compared with those from the guarantee portfolio at 31<sup>st</sup> December 2011;

□ The proposed scoring model does not have a 100% accuracy, as this is not possible.;

□ The data presented in Table 1 above are the values expected in terms of the

distribution of the SMEs expected to be required to pay. Therefore, the value distributions of the default rate will certainly deviate from these projections, influenced by the size of the accessed guarantees.

*Chart. no. 1 - Distribution of the guarantee portfolio without payment application on 31st October 2015, according to the new risk classes*

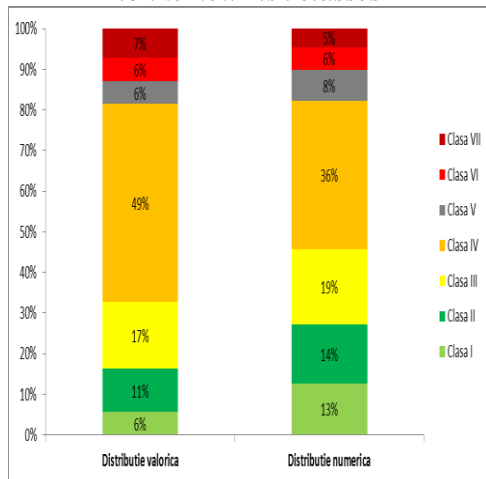

Source: FNGCIMM SA Reports

Notes on Chart. no. 1:

- The processed portfolio is the guarantee portfolio without the payment application depreciation index (beneficiaries which did not fill in a payment application);
- We were unable to identify the risk classes for 3% of the value of balance guarantees and for 7% of SMEs (the vast majority being start-up beneficiaries).

*Chart. no. 2. Top 10 funders with balance guarantees at 31<sup>st</sup> October 2015 (without the payment application depreciation index), distributed according to the new risk classes*

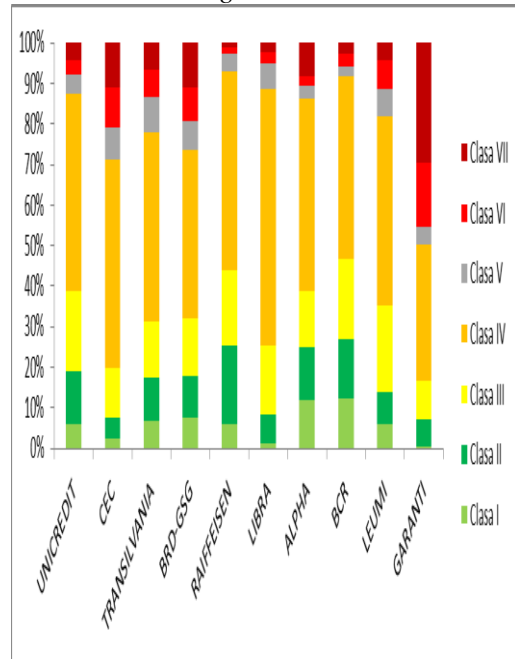

Source: FNGCIMM SA Reports

The data in Chart 2 reveal the following:

- The riskiest portfolio among the top 10 funders was accessed in the relationship with Garanti Bank;
- The best guarantee quality was accessed in the relationship with CBR, Raiffeisen and Unicredit;
- The data in Graph 2 above are good indicators on the funders that will generate future payment applications (within 3 years).

The same portfolio mentioned above was analyzed based on the first year of issuance of guarantees, and the results are shown in Chart 3 below:

Chart no. 3 – Results of first year of issuance of guarantees

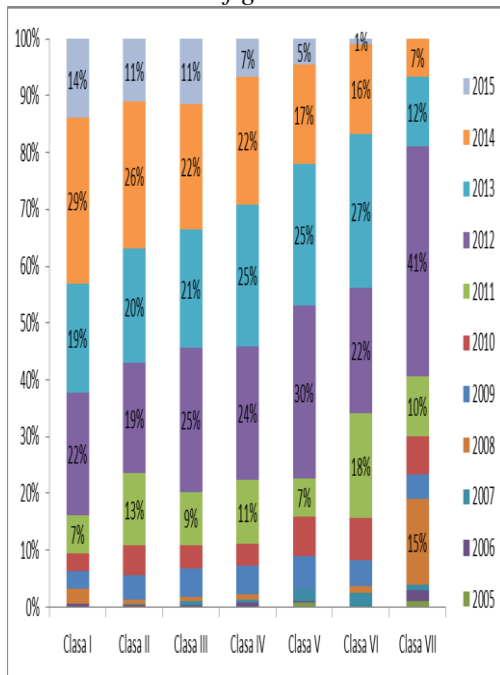

Source: FNGCIMM SA Reports

In Chart 3 we can notice the years when there were launched the exposures from the riskiest classes (V-VIII), as follows:

- 41% of the exposure in class VII was initiated in 2012, while only 12% was initiated in 2013 and 7% in 2014. As far as this class is concerned, a significant percentage (15%) of the exposure was initiated in 2008;

- 22% of the exposure in Class VI was initiated in 2012, 27% in 2013, 16% in 2014 and only 1% in 2015. As far as this class is concerned, a significant percentage of the exposure (18%) was initiated in 2011.

In order to draw better conclusions on the quality of the guarantee portfolio, according to the first year of issuance, Chart 3 was structured differently, triggering the image presented in Chart 4.

Chart no. 4 - Conclusions on the quality of the guarantee portfolio, according to the first year of issuance

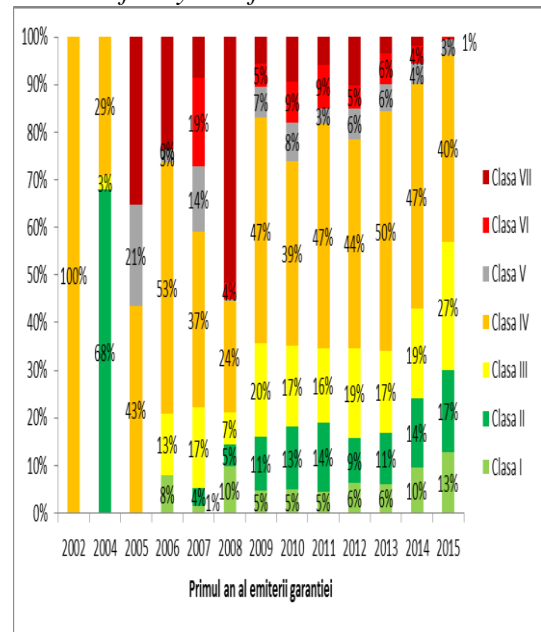

Source: FNGCIMM SA Reports

Chart 4 shows the quality of the guarantees by the year of the exposure initiation, which can be found in the portfolio of 31<sup>st</sup> October 2015, without payment application. No relevant conclusions can be drawn particularly for very remote years. Thus, as far as Graph 4 is concerned, it can not be concluded that 2008 is a very risky year, since it measures only the guarantees initiated for the first time in 2008, which are present in the guarantee balance at 31.10.2015, without making any comment about what happened to all the guarantees initiated in 2008.

### 3. Conclusions

The benefits of implementing the new rating system for the guarantees issued by the National Credit Guarantee Fund for Small and Medium Enterprises under the coverage level covenant are:

1. Changing the risk profile of the guarantees issued under the coverage level covenant can be performed from now on internally, without the necessary updates of the agreements with funders;

2. All the guarantees issued shall be commissioned, depending on the risk rate, thereby ensuring a better risk remuneration.

The policies for granting guarantees under the Covenant on the Guarantee Coverage Level are:

- No new guarantees or additions to the existing guarantees shall be granted unless the SMEs are classified in the risk class I, II, III and IV, as defined within this note;
- The guarantees that extend or diminish the existing guarantees may be granted regardless of the risk class resulting from the proposed model

#### **4. References**

- [1] AUDITUL FONDULUI DE GARANTARE PENTRU IMM-URI, 2011, Luxemburg: Oficiul pentru Publicații al Uniunii Europene.
- [2] Unconventional monetary policies and financial stability: implications for banks and financial markets (2015) - Mugur Isărescu, guvernatorul BNR
- [3] Raportul Anual BNR 2014, [www.bnr.ro](http://www.bnr.ro)
- [4] Raport asupra stabilității financiare 2015, [www.bnr.ro](http://www.bnr.ro)
- [5] Buletinul Fondului Roman de Contragarantare nr 1 (2011/2012/2013), EDITOR: S.C. "Tribuna economica" – S.A.

# BITCOIN Currency - Methods of Adapting to the Economic Crisis

Gheorghe Negoescu

*Ovidius University of Constanta, Romania*

[negoescugl@yahoo.com](mailto:negoescugl@yahoo.com)

Andrei-Mirel Florea

*Dunarea de Jos University of Galati, Romania*

[floreaandrei@yahoo.com](mailto:floreaandrei@yahoo.com)

Aurora Aurelia Diaconu

*Dunarea de Jos University of Galati, Romania*

[auroraureliad@gmail.com](mailto:auroraureliad@gmail.com)

## Abstract

*Given that the global crisis is a cyclical phenomenon that directly affects the company's existence, this adaptation is a condition more than necessary to carry out an activity in a reliable way.*

*Adaptation involves choosing innovative solutions that can withstand market in the current context, as the use of virtual currency Bitcoin as an alternative method in order to remove barriers, given that Bitcoin, a virtual currency created six years ago is not supported or controlled by any government or central bank and is freely traded, fluctuating depending on demand.*

**Key Words:** Global crisis, innovative solutions Bitcoin, the virtual currency.

**J.E.L. Clasification:** F61

## 1. Introduction

Since ancient times financial crisis was a major problem for the economy of all the forms of weather. [1] In general terms the financial crisis is a situation in which monetary capital loses its nominal value in a short time. Since the crisis the Roman Empire from 235-284 when expansion policy, disease and weather events have resulted policies so powerful empire in collapse, until the crisis in Cyprus and Greece when developing policy and banking system led to over indebtedness same result, the crisis proved to be manifest as a cyclical phenomenon, whose prevention is not dependent on political rhetoric on the

economy, does not depend on the entrepreneur seeking ideas for his business, but are generated by macroeconomic developments in the economies of other countries interconnected in terms of financial relations.

## 2. The crisis in Cyprus

Cyprus crisis was caused by the collapse of Laiki Bank, which resulted in money stuck in accounts that depositors order the wealthy to bear the loss and the bank's liquidation.

Two aspects related of Cyprus bank are highlighted in the figure below:

*Figure no. 1. Mainly aspects of crisis influences of banks*

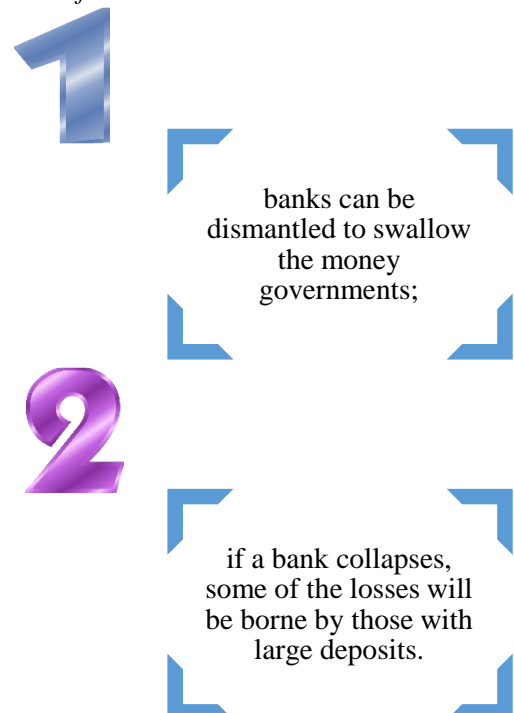

Source: Own contribution

### The causes of this situation

The banking sector drew billion in deposits, including the Russian oligarchs who have established their business in the State insular advantage of the lowest taxes in the EU. Banks have invested heavily in credit and money Greek debt and massive losses when Greece entered the crisis. Cypriot banks have invested heavily also in even the sovereign debt of Cyprus, a fatal situation in which any losses that would force holders of debt as Greece, would be devastated banks

Figure no. 2. Republic of Cyprus GDP evolution in the period 1980-2012 (annual growth rate in real terms %)

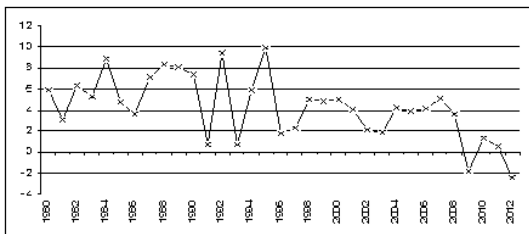

Source: International Monetary Fund, World Economic Outlook Database, April 2013

### 3. The crisis in Greece

In 2010, Greece was supported in the recovery by the emergency aid granted by the EU and IMF. However, in 2011-2013, Greece's economic situation was far from being stable at a pace of GDP growth negatively with unemployment alarming, a high budget deficit and huge public debt

Table no. 1. The main macroeconomic indicators in the period 2011 -2015 Greece

INDICATORS	2011	2012	2013	2014	2015 (estim.)
GDP (real growth rate in%)	-8,9	-6,6	-3,3	0,6	2,9
Total domestic demand (real growth rate in%), of which:					
- Public consumption	-6,6	-5,0	-6,3	-3,1	-2,9
- Productive investment	0,1	1,2	-1,1	-0,3	0,0
Unemployment	17,9	24,5	27,5	26,8	25,0

INDICATORS	2011	2012	2013	2014	2015 (estim.)
rate (% of population active end)					
Budget deficit (% of GDP)	-10,1	-8,6	-12,2	-1,6	-0,1
Government debt (% of GDP)	171,3	156,9	174,9	175,5	168,8
The balance of current payments (% of GDP)	-10,5	-4,3	-2,7	-2,8	-2,5

Source: Adapted after statistical information of Greece National Statistical Institute

### The causes of this situation

Greece did not respect in recent years none of fiscal balance and financial criteria imposed by other Member States of the European Union. Greece managed to hide in various forms all well disguised debts you made in the various international financial transactions and more economic fraud and resorted to all sorts of irregular expenditure in legally.

### 4. Measures of the crisis that affected entrepreneurs in Cyprus and Greece

If the crisis cannot be avoided then the position of entrepreneur you have to adapt to it. As we have seen major institutions affected by the crisis are the banks so that we could perform all transactions in times of crisis without being affected by any restriction imposed by banks, government or other authority.

The effects of crisis in the booth countries over the investors are highlighted on the figure below:

Figure no. 3. Republic of Cyprus GDP evolution in the period 1980-2012 (annual growth rate in real terms %)



Source: Own contribution

If the crisis cannot be avoided then the position of entrepreneur you have to adapt to it. As we have seen major institutions affected by the crisis are the banks so that we could perform all transactions in times of crisis without being affected by any restriction imposed by banks, government or other authority.

## 5. Peer to peer lending markets

Companies in the financial sector network offers profitable alternative debtors, creditors, investors and others involved in traditional financial relationships.[2] For example peer to peer lending markets allow people to provide and obtain loans of money between them without resorting to banks. Through social loans, debtors and creditors get better interest than for the traditional banking model. Barter of goods and services is another alternative financial transaction, which is gaining popularity among consumers.

Due to the global proliferation of the phenomenon of social networking, social lending is beginning to take proportions: p2p appeared credit markets in Japan, Austria, United States, Italy and the Netherlands. The system works just like when you take out a loan or give to family and friends, the only difference being that there are thousands of people willing to agree to your conditions.

## 6. BITCOIN currency - methods of adapting to the economic crisis



Bitcoin is a decentralized electronic payment system and digital currency Bitcoin created in 2009. [3]

The name also refers to the use of open source software for these currencies, as well as peer-to-peer network on which it is formed. [4]

The Internet has changed the way we communicate, Bitcoin currency changes the way money works, and it was created to provide an alternative to the banking system. Unlike other currencies Bitcoin is issued according to a set of fixed rules.

Bitcoin uses a distributed database across nodes of a network of peer to inventory transactions and uses cryptography to provide basic functions for security such as ensuring that the coins Bitcoin can be spent only at you it owns only once.

Bitcoin is a decentralized digital currency first, that can be transmitted over the Internet. Compared to other currencies Bitcoin payment mechanisms have a number of advantages. They are transferred directly from one person to another without going through a bank or other institutions, which means that the fees are much lower, the money can be used in any country, thus avoiding blocking accounts.

## 7. How does Bitcoin?

There are several currency exchange services where you can buy and sell units Bitcoin for dollars, euros and other currencies, Bitcoin network is secure people called miners digital units can be stored in digital wallet on your computer or mobile phone. To check transactions Bitcoin miners are rewarded with freshly generated. [5]

Bitcoin uses a distributed database across nodes of a network of peer (peer-to-peer) to inventory transactions and uses cryptography to provide basic functions for security such as ensuring that Bitcoin cannot be spent only one who holds and only once. Construction currency Bitcoin allows anonymous transfer of ownership and value.

Once the transactions are verified they are registered in a public registry transparent.

Bitcoin is a good method in time of crisis to reduce transaction fees. The costs are minimal and user den ease of implementation and use is an important advantage in selecting this option.

Figure no. 4. Bitcoin currency features

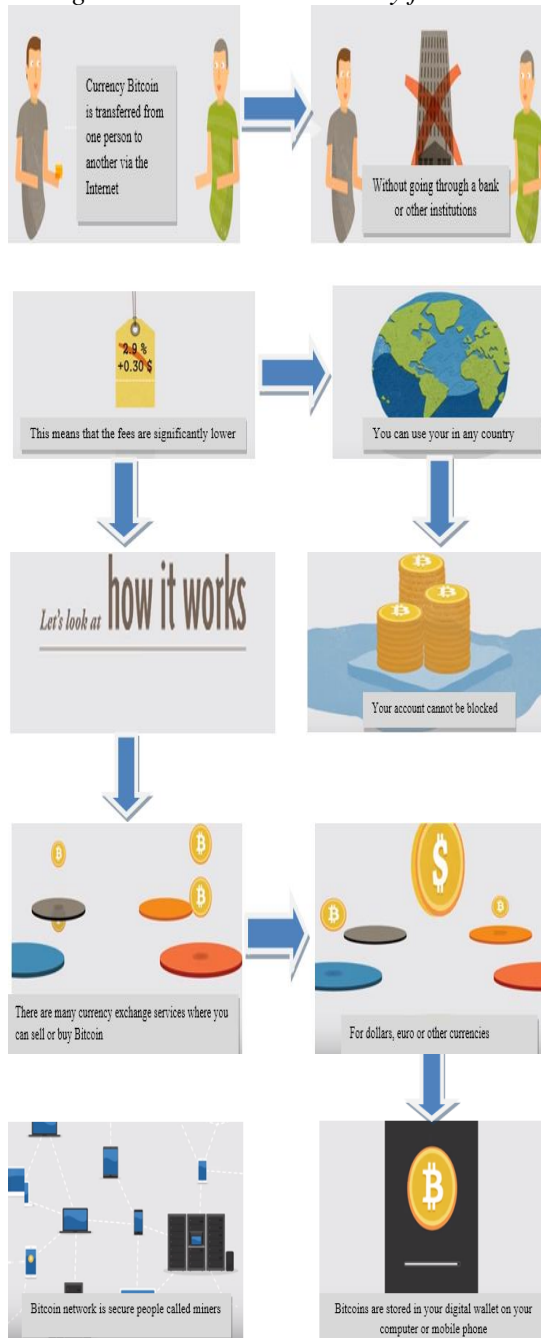

Source: Own contribution

## 8. Conclusions

Bitcoin is a revolutionary technology that enables a new model to send online payments, is a transparent accounting system where thousands of computers worldwide working together to keep track property called Bitcoin digital chips. Most currencies are issued by a central authority that controls the money supply. Bitcoin is a peer to peer

system so there is no central authority.

It's the first currency of the Internet and everyone is free to use, while the global crisis affecting the banking institutions, business entrepreneur can proceed without restrictions.

## 9. References

- [1] Lybeck J. *History of global financial crisis (2007-2010)*, Polirom, Bucharest, 2012, pp 183-185
- [2] Gansky, L., *The Mesh: Why the Future of Business Is Sharing*, Penguin, New York 2010, pp 17-18
- [3] Forbes, "Banxico advierte sobre el uso del Bitcoin," 10 March 2014. [Online].
- [4] [http://www.emoneyspace.com/forum/index.php?topic=365810.0;prev\\_next=next](http://www.emoneyspace.com/forum/index.php?topic=365810.0;prev_next=next)
- [5] Economist, "Bitcoin paradise," 25 December 2013. [Online].



# The Accounting Model for Calculating Performance of Entities and Share Based Payments

Traian Cristin Nicolae

*Department of Finance and Accounting , Faculty of Economic Sciences, University  
"OVIDIUS", Constantza, Romania  
[traian.nicolae.profesor@gmail.com](mailto:traian.nicolae.profesor@gmail.com)*

## Abstract

*The convergence of international accounting problems there may be data standards in english translation in other languages. Not finding an equivalent term would be problematic , but rather implementation of crop specific accounting concepts in a different environment . For example , the concept of true and fair view specific for British accounting , although it has been translated equivalent expressions , have been understood and applied correctly more in the UK. An example of different national interpretation given by the terminology of international standards is the concept of probability , defined in terms of „more likely than not” . It can be interpreted in terms of 60 % , 80 % or 90 % depending on the specific accounting operating culture leading to lack of comparability of accounting information .*

**Key words:** accounting model, overall performance

**JEL:** M41, G32

## 1. Introduction

Current accounting model for calculating performance of a company allows a series of gains and losses not included in the calculation of profit or loss for the period, but to be recognized directly in equity [1]. Although, in principle , all items of income and expense recognized in a period shall be included in profit or loss , some IFRSs require some gains and losses (such as revaluation surplus and certain foreign exchange differences , gains and losses from available for sale financial assets , and related

amounts of current tax and deferred tax) to be recognized directly as changes in equity .

In this context , the financial statements would be incomplete if they only provide information on shareholders' profit for the year and would not provide information on other changes to the their wealth . As a result , the international financial reporting normalization demanded that include a statement of changes in equity detailing all changes in the shareholders' wealth , including gains or losses not recognized in the income statement [2].

However , such a reporting method allows for a performance-related elements together with information on the entity's transactions with its owners , which leads to a less sharp on the company and its performance . In practice of financial reporting , some companies are choosing such a presentation format when it wanted to highlight certain information related to an overall performance weaker, whereas a financial statement containing details of different nature was more difficult to understand by users [4].

## 2. Considerations about reporting entity's overall financial performance

The new financial document , statement of comprehensive income and expenses summarizes both recognized in profit or loss for the period and included directly in equity, information referring to the company's financial performance [3]. Statement of changes in equity includes data on changes in equity as a result of transactions with shareholders or members.

The standard IAS 1- revised- aimed at assessing the overall performance of an entity by calculating the overall result total defined as " change in equity during the period arising from transactions and events other than those changes resulting from

transactions with owners that manifests itself in this position ."

Total comprehensive financial result includes all the accounting profit or loss and other components of comprehensive financial result .

Additional elements of the global financial result are defined as those incomes and expenses ( including reclassification adjustments made) that are not recognized in profit or loss for the financial year under the provisions of IFRS. Additional elements forming comprehensive income include : changes in revaluation reserves , gains and losses relating to defined benefit plans, gains and losses on translation of financial statements of foreign operations, gains and losses on revaluation of available for sale financial assets.

According to IAS 1 standard company's performance can be reported:

- In a unique annual financial statements , namely the overall financial statement ; or
- Two annual financial statements :
- A profit and loss account which describes the components of profit or loss for the reporting period ; and
- Financial statement of comprehensive income, comprising data reporting year and the previous and current year data on profit or loss resulting from other transactions that are classified in other comprehensive income . In a minimal variant, statement of comprehensive income include the following distinct rows :

- the company's income ;
- interest expense ;
- the amount of the profit or loss from investments in associates and joint ventures accounted for using the equity method ;
- income tax expense ;
- a global sum representing the net gain or loss ( net of income tax ) from discontinued operations
- financial result for the year ;
- each item classified by nature in other comprehensive income ;
- other income from investments in associated companies and joint ventures accounted for using the equity method ;
- total comprehensive financial result of the company.

### **3. Share-based payments and reporting performance of the entities**

The share-based payments are transactions in which companies purchase goods or services as consideration for equity instruments of the entity ( including shares or share options) , or acquires goods or services by incurring debts for goods or services for amounts that are based on the entity's share price or other equity instruments of the company.

According to IFRS 2 Share-based payments include [3]:

- a) share-based payment transactions settled through equity , the entity receives goods or services as consideration for equity instruments of the entity ( shares or share options )
- b ) Share-based payment transactions settled in cash by employing entity acquiring debts to the supplier of goods or services for amounts that are based on the price ( or value) of the entity's shares or other equity instruments of the entity, and
- c ) transactions in which the entity receives or acquires goods or services and the terms of the contract gives the entity or provider of goods and services the opportunity to settle the transaction in cash ( or other assets) or by issuing equity instruments [3] .

Transactions with share-based payment settled in cash is a transaction with share-based payment in which the entity acquires goods or services by hiring a liability to transfer cash or other assets providing goods or services for amounts that are based on the price (or value ) of the entity's shares or other equity instruments of the entity .

Transactions with share-based payment settled through equity share is a share-based payment transaction in which the entity receives goods or services as consideration for equity instruments of the entity (shares or share options ) [3].

Under IFRS 2 , the entity shall recognize the assets or services received or acquired in a transaction with share-based payment when the firm get the goods or services are provided. In return , the compny must recognize a corresponding increase in equity if the goods or services were received in the transaction based payment shares, or a liability if the goods or services were

acquired in a transaction with payment based on shares settled in cash [7].

#### **4. Case studies about reporting performance in share-based payments**

Company SC Mall is building a central mall. Company SC Concrete SA delivers eight feeders with a carrying amount of 100,000 currency units ( CU) with a market value of 120,000 CU. In return it receives 12,000 shares with nominal value of 50 CU. How will it affect the previous transaction SC Mall SA's financial situation?

In the example maiden fair value of goods received can be measured reliably and therefore SC Mall recognize you fixed assets worth  $8 \times 120,000 = 960,000$  of CU and equity in return for their money totaling 960,000 CU. Increasing equity capital can be broken down  $12,000 \times 50 = 600,000$  CU and share premium 360,000 CU (the difference between 960,000 and 600,000 CU). SC Concrete SRL will recognize equity (long-term financial instruments under IAS 32 and 39) at fair value 960,000 CU.

#### **5. Share-based payment transactions with employees paid in cash**

Recently, internationally, increasingly more companies have started to pay employees additional benefits in the form of equity securities issued its own or as additional compensation calculated on the basis of its own shares [6]. This has several explanations, namely:

- In most countries of the salaries tax is perceived as onerous and when employers seek cheaper ways of payment of wages;
- options granted to employees are usually taxable when they are exercising or the sale of securities acquired on the basis of their (tax not done at the time of granting the options, as is done for example to wages paid in cash);
- entity benefiting from the deduction of at least a portion of the expense of workers employed;
- Providing pensions as defined benefit (very common way to early 20th century) is regarded as very costly for society due to the evolution of different factors such as increasing the operating lifetime, the average salary, etc .;

- is a stimulating factor for employees (especially managers) need to raise performance to take possession of equities ( sometimes managers will be encouraged to report false performance, in order to further compensated) [6];
- Loyalty is a factor, given that the employee must usually spend a number of years the company for entitlement to benefits;
- Private companies issuing equity as a source very cheap funding and prefer instead to give additional money on salaries to increase the number of shares issued [5].

##### **Example 1**

SC Jupiter was granted on December 22 with 20 options to its employees, with the winter holidays. The options have an exercise worth 10 currency units ( CU) / share and 100 shares can be purchased on the basis of their Jupiter. No additional conditions are required for the exercise. Currently the stock exchange value of a share is 8 CU Jupiter / Action (in other words it does not pay as received options are exercised). SC Jupiter calculated a fair value of 15 CU per options. The number of employees is 100.

How does the financial statements of the previous transaction SC Jupiter?

Since options have no additional condition for the exercise (ie the benefits are already vested) SC Jupiter will recognize an expense for compensation of employees and an increase in return on equity. Although currently not profitable to exercise the option and is not likely to be exercised, this expense will be recognized and will be measured at fair value of options granted. For recording stock options issued by the entity, they could be recognized in the capital, analytically distinct pieces at  $20 \times 15 \text{ CU} \times 100 \text{ employees} = 30,000 \text{ CU}$ .

##### **Example 2**

Darna Company Ltd. grant for all 10 sales agents with 100 options, each entitling to acquisition of 5 shares. The strike price is 9 lei. Currently the fair value of a share is 12 lei.

To exercise the option, the employees should remain in the company for at least 5 years after having access to a 2-year period may opt to purchase the shares.

Applying a model to estimate the fair value of an option, the company calculates fair value of an option as 5 lei.

As the period until employees are entitled to benefits for 5 years, the company will recognize an expense annually depending on the number of equity instruments expected to be exercised by employees. Initially the company estimated that only one employee will leave the team in less than 5 years.

Under IFRS 2, when the performance conditions that are not related to market entity estimates the amount of time until the date on which benefits are entitled and the number of options that will be exercised (depending on the number of employees who will remain employees of likelihood of meeting the performance etc.).

The number of options exercised is likely to be  $100 \times 9 = 900$ .

Value expense recognized in year 1 =  $100 \times 9 \times 5 \times 1/5 = 900$ .

In the second year, the entity reconsider the initial estimates and finds that it is likely that two employees to leave. Since the option is one year closer to the exercise and assume that we share price that rose to 13 lei, its fair value is calculated by your access method 6 lei.

The number of options exercised is likely to be  $100 \times 9 = 900$ .

Although the fair value of equity instruments change, because we have to deal with conditions determined by market performance, not returns on the initial estimate of the fair value of equity instruments granted.

The amount of the expense recognized in year 2 =  $100 \times 8 \times 5 \times 2/5 - 900 = 700$ .

If third-year estimates do not change, the entity shall recognize expenses an amount equal to  $100 \times 8 \times 5 \times 3/5 - (900 + 700) = 800$ .

Suppose in four company believes that it is likely that all 10 employees to remain 5 years employees.

The amount of the expense recognized in year 4 =  $100 \times 10 \times 5 \times 4/5 - (900 + 700 + 800) = 1.600$ .

At the end of May finds that only one employee has left the company and the remaining nine are entitled to benefits.

The amount of the expense recognized in Year 5 =  $100 \times 9 \times 5 \times 5/5 - (900 + 700 + 800 + 1.600) = 500$ .

If the expected period until the date of obtaining the benefits differ depending on certain conditions that are not related to the market, an entity must periodically review, and should recognize the changes.

### Example 3

An entity granted 100 options to its general manager. The exercise period is 3 years from the time the entity's financial return will be 20% or higher.

The fair value of options at the time of grant is 60 lei. The entity estimates that 20% return will be achieved over three years.

In late March, following weak economic conditions, the entity estimates that 20% return will be achieved only in four, not in three.

The first two years the entity recognizes an annual expenditure of  $100 \times 60 \text{ lei options} / \text{option} \times 1 \text{ year} / 3 \text{ years} = 2.000 \text{ lei} / \text{year}$ .

In the third year the expenditure is recognized in equity and value options  $100 \times 60 \text{ lei} / \text{option} \times 3 \text{ years} / 4 \text{ years} - 2,000 \times 2 = 500 \text{ lei}$ .

Assuming that the fourth-year profitability improved over 20% and the manager can always exercise the options, the amount recognized is the expense:  $100 \times 60 \text{ lei options} / \text{options} \times 4 \text{ years} / 4 \text{ years} - 2,000 \times 2 - 500 = 1.500 \text{ lei}$ .

If the number of equity securities granted varies depending on the specific market conditions that are not related to the entity must make the best estimate of the number of equity instruments that will provide entitlement to benefits. This estimate should be reviewed periodically, and changes must be recognized.

## 6. Conclusions

Market conditions, such as target a market price that is conditional exercise should be considered when estimating fair value of financial instruments granted. Therefore, for granting equity instruments in market conditions, the company shall acknowledge the existence of the goods or services bought from another company that meets all the other conditions imposed (e.g. services received from an employee who remains in service for a certain period time) regardless of whether the conditions of the market. [3].

If the performance conditions determined by the market, the entity assumes that the services will be received until the date on which benefits are entitled. Estimated amount of time until the date on which benefits are entitled must be consistent with the assumptions used in measuring the fair value of instruments transmitted, and the amount shall not be revised later [3].

#### Example

The company Search seeks to hire a consultant to whom he provides the equivalent in lei of 100 own shares traded, consultancy services on issues of advertising.

1 share at the grant date was quoted at 8 lei. During the first year the stock was 10 lei per share and paid half the debt.

In late February the quote was 7 lei / share. In March this difference is paid, at which time the action was rated with 9 lei.

On issuance, Search recognizes an advertising expense and debt service equal to  $100 \times 8 = 800$  lei.

The first year, the fair value of debt is  $(100 - 50) \times 10 = 500$ .

Existing debt in the balance sheet:  $800 \times 50\% = 400$ .

The entity will recognize the unfavorable difference in expenses.

In late February, the fair value of debt is  $50 \times 7 = 350$ .

Existing debt in the balance sheet: 500. The entity will recognize the favorable difference in income.

On the settlement date, the fair value of debt is  $50 \times 9 = 450$ .

Existing debt in the balance sheet:  $800 \times 50\% = 350$ .

The entity will recognize the unfavorable difference in expenses.

If the debt value depends on condition, the entity shall estimate the probable obligation.

analysis approach. *Accounting & Business Research* 31 (2): 91-101.

- [3] Nicolae, Traian (2010), "Standarde contabile", Ex Ponto, Constantza, 2010.
- [4] Ryan, S. G. (2008). Accounting in and for the subprime crisis. *The Accounting Review*, 83, 1605–1638.
- [5] Shleifer, A., and R. Vishny, 1997, A Survey of Corporate Governance, *Journal of Finance* 52, 737–83.
- [6] Soderstrom, N., and K. Sun, 2007, IFRS Adoption and Accounting Quality: A Review, *European Accounting Review* 16, 675–702.
- [7] Stulz, R., 1981, On the Effects of Barriers to International Investment, *Journal of Finance* 36, 923–934.

## 7. References

- [1] Armstrong, C., Guay, W., & Weber, J. (2010). The role of information and financial reporting in corporate governance and debt contracting. *Journal of Accounting and Economics*, 50(2–3), 179–324.
- [2] Breton, G, and R. Taffler. 2001. Accounting information and analysts stock recommendation decisions: A content

## Considerations Regarding Lean Approach Within Management Accounting

Dimi Ofileanu

University "1<sup>st</sup> of December 1918", Alba Iulia

[dimi\\_ofileanu@yahoo.com](mailto:dimi_ofileanu@yahoo.com)

### Abstract

*Due to the high competitiveness on the market, the managerial decisions have to be fast and correct because any type of hesitation or error can have major negative effects. Now more than ever, it is very important that the information based on which the decision is made to be accurate and provided in a timely manner in order to justify the quality of the managerial decision. Due to the fact that the traditional accounting is outdated from this point of view because the information is too complex and is not provided in time, the solution would be to use lean accounting instead. The article comparatively presents specific situations which aim to show the way lean accounting works and its terms of use.*

**Key words:** Lean Accounting, Value Stream Costs, Managerial Decisions

**J.E.L. Classification:** M19, M49

### 1. Introduction

In the last 25 years the Romanian economy has evolved from a centralized system economy to a market economy where the rich offer of products leads to a high competitiveness. So, the price of a product is not determined by the producer anymore; it is determined by the market and the producer has to adapt to the customer's requirements. This new approach in setting up the price is directly connected to knowing exactly what the costs for manufacturing a product are so that the managerial decision to be made based on real numbers.

Taking into account the current development stage, there are lots of voices who state that the traditional cost calculation methods are no longer a solution for making managerial decisions. [1], [2], [3], [4], [5].

Many times, the traditional accounting systems provide complex, bushy, confuse and sometimes wrong information. As if this wouldn't be enough, the cost of getting this information is huge because it takes a lot of work and time.

Lean accounting improves the information based on which the managerial decision is made by clearly presenting the chain of creating value the price of the product being approached through the prism of the value created for the customer.

The main feature of lean philosophy is eliminating loss and producing only what the client wants to buy, products for which there are clear orders. From the point of view of lean accounting the overproduction is the biggest loss.

Unlike the traditional accounting methods, lean accounting encourages loss elimination and the growth of stock rotation, reducing them to minimum. High stocks artificially maintain a low cost level because the fix costs are distributed to a higher quantity of products. That is why the transition to lean accounting system has to be made gradually, when the company has reached the proper level to implement lean principles, otherwise the results will be unsatisfactory.

The costs are organized along the value stream within lean accounting. The logic is that the company has to focus around the value it creates for the client, unlike the traditional accounting methods which focus only on cost.

### 2. Aspects regarding the impact of managerial decisions on the structure of production

There are situations when the demand for each manufactured product is high and as the production capacity is limited, the manager has to analyze which of the manufactured

products bring the highest profit and which should be the production structure so that the long and medium term activity of the company to develop in a useful way.

Let's consider a case from footwear industry, where a company manufactures four types of footwear (A, B, C and D) all of them going through the same technologic stream. The maximum manufacturing capacity, in case the products would be individually manufactured, is of 200 pcs./hour for product A, 120 pcs./hour for product B, 150 pcs./hour for product C and 300 pcs./hour for product D.

The standard cost/unit of each product is illustrated below:

Table no. 1. The cost/unit for each product

	A	B	C	D
Material cost	32 lei	46 lei	38 lei	44 lei
Employee cost	8 lei	12 lei	13 lei	6 lei
Overhead cost	10 lei	14 lei	9 lei	12 lei
Total unit cost	50 lei	72 lei	60 lei	62 lei

Source: author's projection

When applying the traditional accounting, the decision regarding the production structure will be taken based on the sale price per unit and the standard cost per unit of each of the four manufactured products, as it follows:

Table no. 2. Gross margin of each product

	A	B	C	D
Sale price per unit	74 lei	99 lei	90 lei	84 lei
Standard cost per unit	50 lei	72 lei	60 lei	62 lei
Gross margin	24 lei	27 lei	30 lei	22 lei

Source: author's projection

Based on this analysis, manager's decision would be to produce as many C products as possible and as less D products as possible, because the gross margin is the largest for product C (30 lei/piece) and the smallest for product D (22 lei/piece).

We assume that there are signed contracts with the clients for the weekly manufactured production, as it follows: 1000 pcs. for product A, 600 pcs. for product B, 750 pcs. for product C and 1500 pcs. for product D. There is a single shift: 7 effective hours/day, 5 days/week.

Because there is additional request for all

four products, the manager will choose to honor the existing contracts and the rest of production capacity will be used to manufacture product C as its gross margin is the largest. In order to honor the existing contracts, the effective time needed is of 20 hours/week. So, the working time available for manufacturing the additional production is of 15 hours/week ([5 days/week x 7 hours/day] – 20 hours/week). Because product C is manufactured in a quantity of 150 pcs./hour, it results that it will be additionally manufactured at 2.250 pcs./week (15 hours/week x 150 pcs./hour). The cost of manufactured production will be:

Table no. 3. The production cost based on the traditional accounting

Product	Quantity	Direct cost/ units	Direct costs
A	1.000 pcs.	40 lei	40.000 lei
B	600 pcs.	58 lei	34.800 lei
C	3.000 pcs.	51 lei	153.000 lei
D	1.500 pcs.	50 lei	75.000 lei
Total direct costs			302.800 lei
Overhead costs			43.150 lei
Total costs			<b>345.950 lei</b>

Source: author's projection

The weekly profit registered by the company, based on the quantity manufactured and sold will be:

Table no. 4. The weekly profit based on the traditional accounting

Product	Quantity	Sale price per unit	Income from sales
A	1.000 pcs.	74 lei	74.000 lei
B	600 pcs.	99 lei	59.400 lei
C	3.000 pcs.	90 lei	270.000 lei
D	1.500 pcs.	84 lei	126.000 lei
Total income from sales			529.400 lei
Total costs			345.950 lei
Total profit			<b>183.450 lei</b>

Source: author's projection

The use of lean accounting when making a decision regarding the structure of the production involves determining the throughput lei/hour meaning taking into consideration the production capacity for each product together with the sale price of

the product and material cost.

Table no. 5. Determining throughput lei/hour for each product

	A	B	C	D
Unit sales price	74 lei	99 lei	90 lei	84 lei
Material cost	32 lei	46 lei	38 lei	44 lei
Throughput margin	42 lei	53 lei	52 lei	40 lei
Throughput units per hour	200 pcs.	120 pcs.	150 pcs.	300 pcs.
Throughput lei per hour	8.400 lei	6.360 lei	7.800 lei	12.000 lei

Source: author's projection

As it can be seen, taken from this perspective, the production structure will generate more benefits if for the available capacity will be used for manufacturing product D, which will generate 12.000 lei for each manufacturing hour.

Honoring the existing contracts, the manager will choose to use the 15 hours/week to manufacture product D, for which there is demand, the additional quantity being of 4.500 pcs./week (15 hours/week x 300 pcs./hour).

The cost of the manufactured production will be:

Table no. 6. The cost of production based on lean accounting

Product	Quantity	Units direct costs	Direct costs
A	1.000 pcs.	40 lei	40.000 lei
B	600 pcs.	58 lei	34.800 lei
C	750 pcs.	51 lei	38.250 lei
D	4.500 pcs.	50 lei	225.000 lei
Total direct costs			338.050 lei

Source: author's projection

The income from weekly sales, based on the manufactured and sold production for each product will be:

Table no. 7. Weekly income based on lean accounting

Product	Quantity	Unit sales price	Income from sales
A	1.000 pcs.	74 lei	74.000 lei
B	600 pcs.	99 lei	59.400 lei
C	750 pcs.	90 lei	67.500 lei
D	4.500 pcs.	84 lei	378.000 lei

Total income from sales	578.900 lei
-------------------------	-------------

Source: author's projection

After honoring the existing contracts and of additional order for product D, the financial indicators for the weekly manufactured and sold production are:

Revenue	578.900 lei
Material costs	286.100 lei
Employee costs	51.950 lei
Overhead costs	43.150 lei
Total value stream costs	381.200 lei
Value stream profit	<b>197.700 lei</b>

As it can be seen, in case the manager's decision is based on the information provided by lean accounting, the obtained weekly profit will be of 197.700 lei while, if the manager's decision would have been based on the information provided by the traditional accounting the profit would have been of only 183.450 lei, which means that lean accounting provides more relevant information for managers.

### 3. Aspects regarding the influence of the inventory over profit indicators

Stock reduction is an important objective of lean philosophy, no matter if we are talking about raw material stocks or finished products stocks. Lean accounting can be successfully applied only within a company which implemented lean manufacturing. A company which doesn't have low stock levels and uses lean indicators to calculate profit will be immediately discouraged, because the results obtained will be much lower than in the case of calculating them based on the traditional methods. In order to better understand let's consider the example below:

Table no. 8. The situation of a company's activity using the traditional result calculation method

Revenue	850.000 lei
Material costs	550.000 lei
Purchases	600.000 lei
– Inventory	50.000 lei
Employee costs	100.000 lei
Machine costs	90.000 lei
Occupancy & other costs	60.000 lei
Total manufacturing costs	800.000 lei
– finished goods inventory	100.000 lei



Total costs of sales	700.000 lei
Gross profit	<b>150.000 lei</b> <b>17,65%</b>

Source: author's projection

Lean accounting, unlike traditional accounting, organizes the company along the value stream and not along its functions.

If the company will calculate the indicators of profit by using lean accounting, it will take into consideration the entire value stream, assuming that the existing stock levels are almost equal to zero. So, material inventory and finished goods inventory won't be subtracted from total costs of sales, influencing the result obtained. This is the reason why lean accounting is recommended only for those companies which implemented lean manufacturing and which are in an advanced implementation level so that their stock levels are almost equal to zero.

As we can see below, lean accounting will provide wrong information, the main cause being that the company is not organized based on lean principles.

*Table no. 9. Calculating the result of a company which doesn't apply lean philosophy by using lean accounting indicators*

Revenue	850.000 lei
Material costs	600.000 lei
Employee costs	100.000 lei
Machine costs	90.000 lei
Occupancy & other costs	60.000 lei
Total value stream costs	850.000 lei
Value stream profit	<b>0 lei</b> <b>0%</b>

Source: author's projection

If the stocks of raw materials are constantly shipped by providers, often and in lower quantities, then they will enter the production immediately and the costs of stocks will be included in material costs.

#### 4. Conclusions

The decisions made based on the information obtained by traditional accounting methods can be wrong. The accounting has to take into consideration the conditions of current economy and to align to the new trends.

Lean accounting provides information

based on value stream, which are more simple, clear and relevant. So, the managers will take efficient decisions, evaluating in a real manner the impact these decisions have over costs and company's profitability.

Also, lean accounting doesn't have to be used by any means. In order to have good results the company has to be prepared and implement the lean thinking principles to all levels and within all activities, including accounting activities.

The use of lean accounting is recommended for the companies that have already implemented lean production and they are in an advanced implementation level. During the initial period of implementation it is recommended to use in parallel both the traditional accounting and lean accounting methods, the aim being to be able to keep track of the results obtained, knowing that lean accounting provides wrong information when the company is not organized after lean principles. Once the maturity is reached the traditional methods are no longer used, lean accounting providing more precise and clearer information.

A lean company wants to reduce stocks to all levels, keeping them to the required minimum. So, the activities that don't add value are eliminated and the cost of the product is reduced. The cost of keeping the stocks in large quantities is high but the traditional accounting methods hide these costs.

Lean accounting is the new method to be used when making decisions based on the available capacity and the existing demand for a company's products.

Lean accounting is the proper method used to identify the benefits of the continuous improvement of a lean company.

#### 5. References

- [1] Maskell, B., Baggaley, B. & Grasoo, L., *Practical Lean Accounting: A proven System for Measuring and Managing the Lean Enterprise. Second Edition*, CRC Press, New York, 2012;
- [2] Maskell, B. & Kennedy, F., Why do we need lean accounting and how does it work?, *Journal of Corporate Accounting & Finance*, 18(3), 2007, pp. 59-73;
- [3] McVay, G., Kennedy, F. & Fullerton, R., *Accounting in the Lean Enterprise*, CRC Press, New York, 2013;

- [4] Ofileanu, D., Aspects Regarding the Application of Lean Accounting in Taking the Managerial Decisions, *Ovidius University Annals, Series Economic Sciences*, 15(1), 2015, pp. 941-944;
- [5] Womack, J. & Jones, D. T., *Lean Thinking*, Free Press Business, 2003.

## Real Economic Growth for Romania – the Key Element Savior for a Long Period of Time?

*Motto:*

*„ The economy is a living system composed of human beings and social bodies are in continuous interaction with each other and with the ecosystems surrounding them and which our lives depend.”  
Fritjof Capra*

Loredana Maria Păunescu  
Petroleum&Gas University, Ploiesti, Romania  
[loredana.paunescu@yahoo.com](mailto:loredana.paunescu@yahoo.com)

### Abstract

*The human component ushers mankind was caring for the environment in which the risks arising from the development of economic processes should be reduced or even removed if they have negative effects.*

*Through education, culture and science, people can overcome a perception threshold that will lead them to observe and act in the long term according to their needs.*

**Key-words:** economic growth, human capital, economic processes, economic indicators, economic forecasts.

**JEL Classification:** A, A2, A23.

### Introduction

Political, social and economic profound taking place in the Romanian have a considerable impact both in public opinion and among the media.

Using and perfecting the most of human capital through promoting social inclusion and strengthening administrative capacity for developing a modern labor market and flexible that can absorb the young labor force and specialized in various fields will generate economic and social changes essential and positive both at macro and micro level. [1]

It also will be seen improve the relevance of education and training for employment, stimulate and develop an entrepreneurial culture.

Reform Strategy in the Romanian economy seen under the influence of the human factor must be addressed taking into account the big gap in the world today, the classification and the differentiation between

countries according to their degree of development and cataloging them as poor as rich countries or countries.[2]

Looking at the overall picture of the actual development of the world we live in economically, researches have led to the following view, namely that, according to economic indicators that it considers the health of the global economy, the world is in a relatively good situation and long-term economic prospects are promising.[3]

In this regard, economists believe that advanced technologies can be used in a positive and effective in their work.

### Obiectives

For this analysis, particular interest to make a connection is stable and secure future between companies employing young people with higher education and economic.

The research conducted is considering several objectives:

O<sub>1</sub>: creating a favorable environment for the creation of new companies based on knowledge;

O<sub>2</sub>: improving employability and facilitate access to the labor market and working life to a greater number of young people;

O<sub>3</sub>: providing youth guarantee a successful combination between knowledge and practical experience.

### Research methodology

The research was initially started by analyzing documents, followed by the survey among young people, employers, local authorities.

### Research methods and techniques

Instead, most useful information resulting from the questionnaire analysis piloted among students and masters, as can be seen from Table 1:

*Table 1. First research methods*

The proposed method	Frequency	%
Document analysis	5	20,0
Sounding	11	25,0
Questions	13	30,0
Interview	6	15,0
Focus groups	10	10,0
Total	45	100,0

Source: author

The questionnaire contained 12 questions open, in the majority, aiming at finding out their views freely expressed.

An alternative choice of research methods was to complete the analysis methods used in the early stages juxtaposing observation as to be presented in Table 2:

*Table 2. The second research methods*

The proposed method	Frequency	%
Document analysis	10	25,0
Sounding	11	15,0
Questions	10	15,0
Interview	5	20,0
Focus groups	7	20,0
Observation	2	5,0
Total	45	100,0

Source: author

## Research results and discussion

The analysis points to the project with the title ProActiv - Integrated program for employment in the labor market in the North East, South Muntenia and Bucharest Ilfov as partners:

Applicant: SC RomActiv Business Consulting SRL • Partner 1: SC Profile Business Consulting SRL • Partner 2: CAE Iași • Partner 3: CAE Bacau • Partner 4: CAE Dambovita • Partner 5: CAE Arges • Partner

6: CEA County.Aria de implementare a proiectului a cuprins:

- North East Region: Iasi, Bacau, Neamt, Botosani, Suceava, Vaslui;

- South Muntenia: Arges, Prahova, Dambovita, Calarasi, Teleorman, Ialomita, Ilfov Giurgiu ;

- Region: Ilfov.

The project will: March 2014 - September 2015.

The target group was made up of young unemployed and looking for work.

The overall objective is to improve employability and facilitate access to the labor market and working life of a number of 800 people with a difficult situation on the labor market such as people looking for a job, the unemployed, including the young and elderly and long-term unemployed in order to increase the employment of labor in the North East, South Muntenia and Bucharest Ilfov.

The main activities are:

- counseling offered to the unemployed to find a job;

- starting a business or employed in four professional advice and entrepreneurial centers in Bucharest, Bacau, Iasi, Targoviste;

- 48 sessions and specialized training courses;

- 12 interactive seminars on "The labor market between two visions - the unemployed versus employers". The seminars include representatives of businesses that recruit and employ staff in the area and representatives of investors who have announced their intention to develop business in the regions covered by the project and to hire in the future.

- 14 job fairs.

Another project initiated and which targeted the same objective, and-which is to assist young people is organized by the National Council of Private Small and Medium Enterprises in Romania (CNIPMMR) conducted between April 1, 2014 - November 30, 2015 draft SIMPRACT - Transition from school to work through practice and business creation simulated project being implemented in partnership with the Association of Young Entrepreneurs in Romania (YEAR) and eight prestigious universities in Romania, namely: Academy of Economic Studies (ASE ), "Ovidius" University of Constanta, "Dunarea de Jos"

University of Craiova, "Lucian Blaga", Technical University "Gheorghe Asachi" University, "Valahia" University of Targoviste, University "Constantin Brancusi" in Tirgu Jiu.

## Conclusions

The SME sector is probably the most affected, with a structure which shows a relatively low orientation towards productive activities, as can be seen from the current situation analysis.[4] Despite the positive trend, the share of SMEs in GDP is still insufficient, requiring both quantitative growth and qualitative SME sector. SME access to capital, technology and infrastructure is low, far below the level that would allow the exercise of the vital role of SMEs in economic competitiveness through introducing innovative processes with flexibility and adaptability to market requirements.[5]

Regional SME needs analysis emphasized that a cause of the poor performance of innovative companies is the lack of entrepreneurship, knowledge management and skills of local entrepreneurs. Up companies face more obstacles compared with existing companies already in the labor market.

Thus, in general, these companies do not have a stable position on the market, trying to convince potential investors about the Company's future success and usually a deficiency of staff and financial resources.[6] Such companies need help to transform (transposition) pilot a business idea into a successful company.

Creating a favorable environment for the creation of new companies based on knowledge is to promote and encourage a business culture (one that rewards success and treat failure as an opportunity to study) and the physical infrastructure reliable (incubators and accelerators Affairs).[7] Hence, it aims to provide support for understanding the spirit of an entrepreneur, demonstrating their benefits and facilitating access to capital for pre-opening and opening businesses, and the promotion of new innovative ways of individual investments.[8]

Access to specialized services is also crucial for beginners because potential

entrepreneurs to acquire skills and knowledge required for running a company.[9] In this regard, support will be provided to develop advisory and mentoring schemes, which are the main approaches effective in trying to provide new entrepreneurs successful combination of knowledge and practical experience. [10] In order to stimulate local entrepreneurship can play a key role and researchers can improve their managerial skills.

## Authors' contributions

The author conducted research used analysis methods and tools appropriate and extremely useful that led to obtaining meaningful results. It was followed by document analysis survey among students, employers, local authorities, the questionnaire piloted among them.

Research continued interviewing academics, and others follow focus groups with students and masters in economics.

Interview duration was 30 minutes for each question respondents having to 2 minutes.

Focus groups held with students and master's contained six questions.

An alternative choice of research methods was to complete the analysis methods used in the early stages juxtaposing observation.

## References

- [1] Aceleanu, M.I., *Lifelong Learning – Necessity For Romanian Labour Market Flexibility*, Proceedings of the 6th International Conference on Business Excellence, Vol 2, 2011;
- [2] Dávila Gómez, A. M., Crowther D. , *Human Dignity and Managerial Responsibility: Diversity, Rights, and Sustainability*, Gower Publishing, Ltd., England, 2012;
- [3] Jackson S E., Schuler R. S., Werner S. , *Managing Human Resources*, USA: Cengage Learning, 2012;
- [4] Aceleanu, M. I., *The Relationship Between Education And Quality Of Life. Implications Of The Labour Market In Romania*, Journal of International Scientific Publications, Vol 9, Part 2, 2011;
- [5] Kearns, P., *HR Strategy, Creating Bussiness Strategy With Human Capital*, USA: Butterworth – Heinneman, 2010;

- [6] Datalo, A., *Strategies to Approximate Random Sampling and Assignment*, Oxford: Oxford University Press, 2010;
- [7] Argăseală., M., *Formarea continuă a angajaților – șansa unor întreprinderi inovative cu angajați pasionați de munca lor*, București, POSDRU/62/2.3/S/22025, 2012;
- [8] Rothwell, W. J., Lindholm J., Yarrish K. K., Zaballero A., Ed. by William Rothwell, *Encyclopedia of Human Resource Management, Human Resources and Employment Forms*, , San Francisco: John Wiley & Sons, 2012;
- [9] Lawler, E. E. , Boudreau J. W. , *Effective Human Resource Management, A Global Analysis*, , Standford University Press, Standford California, 2010;
- [10] Jackson, S. E., Ones D. S., Dilchert S. (Ed.) *Managing Human Resources for Environmental Sustainability*, The Professional Practice Series, 2012.

## Regulatory Accounting When Securities Markets Are Stressed

Mitica Pepi

University of Ovidius, Constanta

[pepi.mitica@gmail.com](mailto:pepi.mitica@gmail.com)

### Abstract

*While market prices can be useful tools for bank regulation, recent theoretical work argues that reliance on prices can be counterproductive when secondary markets are stressed and illiquid. Evidence from the financial crisis unearthed (in press) provides empirical validation of these arguments. The market analysts do not fully acknowledge it, their findings suggest that forcing banks to count liquidity-induced unrealized losses in securities holdings against regulatory capital destroys value and exposes bank creditors, including taxpayers, to more risk. Policy makers contemplating greater regulatory reliance on market prices ignore these findings at their peril.*

**Key words:** Market, regulatory, accounting, securities, risk .

**JEL :** G1,G2,M4

### 1.Introductions

In a banking system with government-sponsored deposit insurance, the government is every bank's most senior creditor. In order to avoid exposing the taxpayer to uncompensated risk [1], the government, like other senior creditors, monitors and limits bank risk-taking. It does so through regulations which primarily involve imposing minimum ratios of capital to risk-weighted assets, similar to the leverage covenants that private senior creditors impose on firms in unregulated sectors. Unfortunately, the computation of such capital ratios is not always straightforward. One important question is how to consider the value of bank financial assets. If the government's primary objective were to minimize risk to the taxpayer, it seems intuitive to use the most conservative number

possible. If the asset trades in a secondary market, it would seem the lesser of market value and historical cost would be appropriate.

The market analysts (in press) present evidence that this intuition is wrong when the secondary market for the asset is stressed and illiquid. Their results imply that forcing banks to mark financial assets down to market in such circumstances can cause banks to act in ways that, in addition to destroying bank shareholder value, expose taxpayers to more risk, not less. Though they do not acknowledge it, their results show that the relaxing of impairment rules when secondary markets are stressed benefits all claimants on bank assets, including the taxpayer. The markets analyst provide some of the first empirical validation of theoretical arguments highlighting the dangers of regulatory reliance on market prices when markets are stressed and illiquid.

In the rest of this discussion, I will elaborate on my interpretation of the market analyst [2]. (in press) results and their implications for bank regulatory accounting. In Section 2, I present background information on mortgage-backed securities markets and bank regulatory accounting rules changes during the crisis of 2008–2009. In Section 3, I discuss why economic theory suggests that excessively conservative impairment rules might actually increase the risk exposure of the taxpayer. In Section 4, I explore the results of Bhat et al. and explain why I believe them to have the implications I state above. Also in this section, I elaborate on some of my differences in interpretation . In Section 5, I present concluding thoughts.

### 2.Background on MBS markets and regulatory accounting during 2008–2009

The markets analyst show, banks classify the vast majority of their mortgage-backed securities as "available for sale," and hence

report them at fair value on their balance sheet. Bank regulators, however, only consider the amortized historical cost, less any other-than-temporary impairments (henceforth "OTTI") for the purposes of determining compliance with regulatory capital standards. Hence unrealized losses in mortgaged backed securities only adversely affect a bank's regulatory capital if they result in OTTI. Until early 2009, FSP EITF 99-20, FAS 115 and FAS 157 governed the question of when a bank's unrealized capital loss in debt securities would result in an OTTI.

The financial crisis that began in 2007 stressed secondary markets in fixed income securities to an unprecedented degree, creating massive declines in liquidity. For some mortgaged - backed securities, markets broke down completely and all trading ceased. In other cases, trading continued, but consisted of mostly distressed transactions, resulting in prices unlikely to reflect fundamental value. Since banks were widely holding these securities, under the accounting rules of the time, many banks were forced to recognize large, regulatory capital-reducing OTTI, even though, in many cases, the "impaired" securities continued to make coupon payments and showed no signs of default. Banks began to lobby congress, the FASB, and regulators for a relaxation of impairment rules, receiving the endorsement of the SEC chairwoman Mary Shapiro and Federal Reserve chairman Ben Bernanke.

As Bhat et al. point out, the lobbying efforts succeeded. FASB revised rules governing securities impairments by issuing FSP EITF 99-20-1 on January 12, 2009, as well as FAS 115-2, FAS 157-4, and FAS 124-2 on April 9, 2009. I will not discuss technical details of the rule revisions here. For my purposes, it suffices to note that they made it easier for banks to classify unrealized losses in mortgaged backed securities as "temporary" rather than "other-than-temporary." Thus the rules decreased the odds that liquidity-induced unrealized losses in bank-held securities would result in a deterioration of the bank's regulatory capital ratio or a negative hit to earnings.

### **3. Economic theory and excessively conservative rules on impairment**

To see how excessively conservative impairment rules might actually worsen the taxpayer's risk exposure, consider a situation in which there is a negative liquidity shock to a secondary market in securities that happen to be widely held by banks. Such a shock can cause securities prices to drop significantly below fundamental value, and there is evidence that this was happening in the market for mortgage backed securities during the financial crisis of 2007–2009 ,[3]. If banks continue to hold their securities, this drop in prices can force them to recognize other-than-temporary impairments (OTTI), thereby causing their regulatory capital ratios to deteriorate.

The nature of negative liquidity shocks is such that traders who sell earlier experience fewer short-term losses . Show that banks wishing to minimize short-run unrealized losses in their securities holdings in order to, for example, avoid a decline in regulatory capital, have an incentive to sell as quickly as possible into a negative liquidity shock. By selling they take a realized capital loss, which adversely impacts their capital ratio somewhat. However, if they sell early enough, this loss could plausibly be less bad than the OTTI they would have to recognize if they did not sell, and hence the sale mitigates their deterioration in regulatory capital.

Nevertheless, banks still destroy value by selling into negative liquidity shocks. Selling when liquidity is drying up necessarily involves selling at below fundamental value , which implies the banks are reducing the value of their assets and hurting shareholders. On the other hand, such sales do not in any way reduce the amount of creditor claims on the bank, so they effectively increase the bank's leverage, worsening the position of all creditors, including taxpayers.

As Bhat et al. note, the model of Plantin et al ,[5] provides another story for why banks might sell into negative liquidity shocks to avoid OTTI: managerial earnings myopia. All that is necessary to generate the model's result is a strong preference of the bank to avoid short-term unrealized capital losses. While this preference could result from a bank's desire to avoid a reduction in regulatory capital, it could also result from managerial myopia about earnings. Since OTTI reduce current period earnings, myopic



managers who care excessively about near-term earnings might sell into a negative liquidity shock if doing so can avoid an OTTI hit to earnings, even if such sales ultimately destroy value.

Whether bank selling into negative liquidity shocks is caused by regulatory compliance concerns or managerial earnings myopia, the implications for policy are the same. In both cases, such selling destroys value for bank shareholders and creditors, including the government, so in both cases, giving banks more latitude in not taking OTTI in response to unrealized losses could make all parties better off. Bhat et al. state that their results are consistent with both theoretical causes of banks selling into liquidity shocks. However, as I clarify in the next section, I believe some of their results make it more likely that the regulatory compliance story is the more plausible explanation.

#### 4. Model checking bank stress

The model is based on the analyses of crises and systemic risk and particularly in banks sector. A standard model of intermediation is extended by adding an insurance sector. The two sectors face risks that are not perfectly correlated so there is scope for diversification.

There are three dates  $t = 0, 1, 2$  and a single, all-purpose good that can be used for consumption or investment at each date. The banking sectors consist of a large number of competitive institutions and their lines of business do not overlap. This is a necessary assumption, since the combination of intermediation and insurance activities in a single financial institution would eliminate the need for markets and the feasibility of mark-to-market accounting.

There are two securities, one short and one long. The short security is represented by a storage technology: one unit at date  $t$  produces one unit at date  $t + 1$ . The long security is a simple constant-returns-to-scale investment technology that takes two periods to mature: one unit invested in the long security at date 0 produces  $R > 1$  units of the good at date 2. We can think of these securities as being bonds or any other investment that is common to both

banks. Initially we assume there is no market for liquidating the long asset at date 1.

Banks companies have distinct direct investment opportunities and liabilities. Banks can make loans to firms. Each firm borrows one unit at date 0 and invests in a risky venture that produces  $B$  units of the good at date 2 with probability  $\beta$  and 0 with probability  $1 - \beta$ . There is assumed to be a limited number of such firms with total demand for loans equal to  $z$ , so that they take all the surplus and give banks a repayment  $b (\leq B)$ , as we describe more fully below. We assume throughout that there is no market for liquidating loans at date 1.

Banks raise funds from depositors, who have an endowment of one unit of the good at date 0 and none at dates 1 and 2. Depositors are uncertain about their preferences: with probability  $\lambda$  they are early consumers, who only value the good at date 1, and with probability  $1 - \lambda$  they are late consumers, who only value the good at date 2. Uncertainty about time preferences generates a preference for liquidity and a role for the intermediary as a provider of liquidity insurance. The utility of consumption is represented by a utility function  $U(c)$  with the usual properties. We normalize the number of depositors to one. Since banks compete to raise deposits, they choose the contracts they offer to maximize depositors' expected utility. If they failed to do so, another bank could step in and offer a better contract to attract away all their customers.

Insurance companies sell insurance to a large number of firms, whose measure is also normalized to one. Each firm has an endowment of one unit at date 0 and owns a machine that produces  $A$  units of the good at date 2. With probability  $\alpha$  state H is realized and a proportion  $\alpha H$  of machines suffers some damage at date 1. Unless repaired at a cost of  $\eta < A$ , they become worthless and produce nothing at date 2. With probability  $1 - \alpha$  state L is realized and a proportion  $\alpha L$  of machines suffer some damage and need to be repaired. Thus, there is aggregate risk in the insurance sector in that the fraction of machines damaged at date 1 is stochastic. Firms cannot borrow against the future income of the machines because they have no collateral and the income cannot be pledged. Instead they can buy insurance against the probability of incurring the damage at date 1

in exchange for a premium  $\phi$  at date 0. The owners of the firms consume at date 2 and have a utility function  $V(C)$  with the usual properties. We introduce a class of risk neutral investors who potentially provide capital to the banking sectors. Investors have a large (unbounded) amount of the good  $W_0$  as endowment at date 0 and nothing at dates 1 and 2. They provide capital to the intermediary through the contract  $e = (e_0, e_1, e_2)$ , where  $e_0 \geq 0$  denotes an investor's supply of capital at date  $t = 0$ , and  $e_t \geq 0$  denotes consumption at dates  $t = 1, 2$ . Although investors are risk neutral, we assume that their consumption must be non-negative at each date. Otherwise, they could absorb all risk and provide unlimited liquidity. The investors' utility function is then defined as  $u(e_0, e_1, e_2) = \rho W_0 - p e_0 + e_1 + e_2$ , where the constant  $\rho$  is the investors' opportunity cost of funds. This can represent their time preference or their alternative investment opportunities that are not available to the other agents in the model. We assume  $\rho > R$  so that it is not worthwhile for investors to just invest in securities at date 0. This has two important implications. First, since investors have a large endowment at date 0 and the capital market is competitive, there will be an excess supply of capital and they will just earn their opportunity cost. Second, the fact that investors have no endowment (and non-negative consumption) at dates 1 and 2 implies that their capital must be converted into assets in order to provide risk sharing at dates 1 and 2.

All uncertainty is resolved at the beginning of date 1. Banks discover whether loans will pay off or not at date 2. Depositors learn whether they are early or late consumers.

## 5. The empirical results of research and their meaning

The empirical results of research provide convincing evidence that regulatory compliance concerns can drive banks to sell into liquidity shocks, and that this behavior destroys value. Specifically, they find that during the financial crisis, banks initially responded to liquidity-induced price declines in mortgage-backed securities by selling, thereby acting as consumers of liquidity

rather than providers. However, this behavior stopped after the relaxation of impairment rules in early 2009. The markets also find that the aforementioned selling behavior prior to the rule change was strong only in banks with low regulatory capital ratios, implying it was regulatory compliance concerns, and not earnings myopia, that was driving their selling behavior. Supporting the notion that conservative impairment rules caused value-destructive sales. The markets analysts find that bank stock prices responded favorably to rule-change news. Further, this price reaction is positively related to a bank's tendency to sell into liquidity shocks prior to the rule change. Finally, they find that bank bond prices also responded favorably to the rule change news.

Bhat et al. have a more modest interpretation of these results than I do. They acknowledge their evidence implies that relaxing of impairment rules did stop inefficient bank selling behavior, which is destructive for all claimants on bank assets, including the taxpayer. However, they also point out that relaxing impairment rules potentially transfers wealth from taxpayers to other bank stakeholders. By giving banks more discretion not to mark their financial assets down to market, regulators might be allowing banks to inflate their capital ratios. Hence the relaxed rules might allow an undercapitalized bank to access the discount window, TARP, deposit insurance, and other forms of cheap government capital intended and priced for well-capitalized banks, thereby exposing taxpayers to uncompensated financial risk. Thus while their results suggest the impairment rule relaxation did indeed stop an inefficient behavior, Bhat et al. say they cannot conclude it created net value, as the increase in stock and bond prices associated with the rule change could be a result of an inefficient risk transfer to taxpayers. Bhat et al. label this the "regulatory forbearance hypothesis," and that is how I will refer to it henceforth.

In order to evaluate whether the regulatory forbearance hypothesis can explain the Bhat et al. results, it is important to understand how the interests of bank stockholders and bondholders differ, and how they compare to that of the government. Bank bondholders differ from shareholders in

that they have a fixed claim on the bank's assets, without upside. As such, bondholders share with the government an interest in keeping the bank's capital ratio high. Therefore, bondholders would be hurt if, as according the regulatory forbearance hypothesis, the dominant effect of the rules change was to allow banks to mask a deteriorating capital ratio from regulators. Bondholders have an interest in a deteriorating capital ratio getting exposed to regulators as quickly as possible, because once that happens, regulators force the bank to reduce leverage, benefiting bondholders. Thus if the dominant effect of the rules change was an uncompensated risk transfer to taxpayers in the form of greater regulatory tolerance of low bank capital ratios, bank bond prices would have declined on the news. The fact that they increased, therefore, suggests this regulatory forbearance hypothesis does not dominate.

But what if a deteriorating capital ratio threatens to cut off a bank's access to cheap sources of government credit? Would it not be in the bondholders' interests to mask that inadequate capital ratio so as to maintain the bank's access to the discount window, TALF, TARP, and the rest of the alphabet soup of government programs being thrown at the financial system in 2008–2009? Unless the bank is already insolvent, the answer is no. A solvent but undercapitalized bank can improve its capital ratio by issuing equity or using asset sales to pay down debt. Hence it is in the bondholders' interest for regulators to require a solvent but undercapitalized bank to improve its capital ratio as a condition to accessing government funding programs. If a solvent but undercapitalized bank is allowed to access the programs without improving its capital ratio, there is a wealth transfer from taxpayers, but it goes to the shareholders, since the bondholders have only a fixed claim with no upside.

Applying mainstream corporate finance theory suggests that the only condition under which bondholders would benefit from regulatory forbearance is when the bank is at or near insolvency, when the claims of bondholders are akin to equity. Hence if some of the banks with bonds in the sample of Bhat et al. were actually insolvent or close at the time the news of the impairment rules

changes, increases in bond prices on the news would be consistent with the regulatory forbearance hypothesis. However, in private correspondence, Bhat et al. confirmed that all the banks in their sample with public bonds were well-capitalized, with regulatory capital ratios around double the legal minimum. Hence the fact that bond prices increased upon news of the impairment rules changes is inconsistent with the regulatory forbearance hypothesis.

## 6. Conclusions

The results of our research in provide a sobering warning against blindly relying on market prices for policy and regulation. While market prices can be extraordinarily useful tools, they are not perfect, especially when markets are stressed and illiquid. The research results suggest it is essential for regulators to ensure a market is deep and orderly before considering using price inputs in rules or as action triggers. Given the plethora of policy proposals being circulated today for greater regulatory reliance on market prices, the Bhat et al. paper could not be more timely.

## 7. References

- [1] Allen, F., Carletti, E., 2008. Market to market accounting and liquidity pricing. *Journal of Accounting and Economics* 45, 358–378.
- [2] Bhat, G., Frankel, R., Martin, X. Panacea, pandora's box, or placebo: feedback in bank mortgage-banked security holdings and fair value accounting. *Journal of Accounting and Economics*, in press. Doi :10.1016/j.jacceco.2011.06.002.
- [3] Bleck, A., Gao, P., 2010. Where does the Information from Marking to Market come From? Working Paper. The University of Chicago. Krishnamurthy, A., 2010. How debt markets have malfunctioned in the crisis. *Journal of Economic Perspectives* 24, 3–28.
- [4] Morris, S., Shin, H.S., 2004. Liquidity black holes. *Review of Finance* 8, 1–18.
- [5] Plantin, G., Sapra, H., Shin, H.S., 2008. Marking-to-market: panacea or pandora's box? *Journal of iAccounting Research* 46, 435–460.

# Defining and Measuring Bank's Equity Risk: Evidence from the Erste Bank Group Romania

Ioana Pleșcău

Alexandru Ioan Cuza University of Iași

[ioana.plescau@yahoo.com](mailto:ioana.plescau@yahoo.com)

## Abstract

*In this paper we have computed and analyzed the VaR of Erste Bank Romania, in comparison with the VaRs of three important peers of this bank. We have used 500 daily stock returns in order to calculate values at risk with the historical simulations approach at a confidence level of 99%. Also, we have tested the hypothesis regarding the existence of a relationship between the VaR of the market index BET and the VaRs of each bank. Our findings could not reject this hypothesis.*

**Key words:** value at risk, market risk, historical simulations

**J.E.L. classification:** G21, G32, C63

## 1. Introduction

Recent financial events on the global market have brought into discussion the need for new approaches of risk measurement. The financial crisis had different impacts on developed markets compared with emerging markets. As an emerging market, Romania has been hardly hit by the adverse effects of the crisis: the quality of the loan portfolio, the increase in the loan loss provisions or the increased credit risk is just a few of the immediate effects. One lesson that should be learned from the recent financial crisis is related to the importance of applying different methods of measuring a bank's risk related to its market exposure.

The possible changes in the market value of a position held by a financial institution correlated with the unexpected changes in the market are defined by *market risk*. When the market value of a position is influenced by the changes in the stock performance (volatility of returns), we will relate this to

the *equity risk*. In order to estimate different levels of risk associated with different positions of a bank within a market, value at risk methods (VaR) try to estimate the level of maximum loss that a financial entity can have.

The purpose of this paper is to investigate the level of market risk at Erste Bank Romania in comparison to three of its peers, in order to see the levels of risk exposure related to their position in a time of financial uncertainty.

The remainder of this paper is structured into four main parts. In the first part we review the previous literature regarding the key concepts and the perspectives of other researchers, with respect to market risk measurement. In the second part of our study, we present the data and methodology used in order to emphasize the added value of our research. The third part will analyze the results and explain the logic of our view and the underlying motivation of our findings. The final part will summarize them and present a conclusion about the measurement of market risk compared with the peer banks.

## 2. Literature review

The aim of this section is to review the existing literature on different methods for computing the Value-at-Risk. Firstly we will review the existing literature with a focus on the concepts that are related to equity risk and which can be used to clearly define it. Secondly we will focus our attention on the differences between these methods and finally we will try to create our own approach about the method that should be used to measure equity risk in the Romanian banking system. Further, this method will be applied on our selected bank and the results will be compared with those obtained for the peers.

With regard to market risk, there are some

authors who define it as the change in net asset value which happens because of changes in some economical factors as interest rates, exchange rates, equity or commodities prices [11].

An important step in the effort of critically presenting different approaches to VaR was made by Beder (1995) who referred to VaR as a seductive, but dangerous method. On the one hand, the author states that it is a seductive method, because of its simplicity at the conceptual level. The same view is shared by Pristker (1996), who presents VaR as a conceptually simple and flexible method. On the other hand, VaR is presented as a dangerous method, because of the different approaches to calculation, but also because of the dependency of VaR on parameters, data, assumptions and methodology. This dependency is demonstrated by the results of our study.

Regarding the time horizon and confidence level, Derivatives Policy Group proposed a time horizon of two weeks and a confidence level of 99%. The Bank for International Settlements (BIS) has set the confidence interval to 99% and time horizon to 10 days. Also, many banks use a daily VaR measure for internal proposes, as opposed to the two-week standard that is required for disclosure to regulators, with a 99% confidence level. J. P. Morgan considers a time horizon of 1 day and a confidence interval of 95%. [11]

The large majority of the national supervisory authorities with respect to banking activities allow financial institutions to use internal models that have the main objective of measuring the level of market risk and exposure. The acceptance of the model is given by its power to demonstrate its accuracy through external validation. Many researchers ([8], [6], [9]) consider that this degree of freedom given by the supervisory authorities might have some perverse effects. Lucas (2001) considers that it is rational for the banks to intentionally understate the risk measurement. Cassidy and Gizycki (1997) consider that the models used by the banks present a high degree of inaccuracy. Finally, Perignon and Smith (2010), have argued that VaR method using the historical simulation do not contain the demanding information to measure the future trading revenue volatility.

Taking into account the reviewed literature, we will focus our analysis on measuring market risk exposure on the Romanian banking system with emphasis on the VaR methods used by the Erste Group Romania, BRD – Groupe Societe Generale, Transilvania Bank and Carpatica Bank, the only 4 banks that are listed on the first category of the Bucharest Stock Exchange.

Although the growing criticism regarding the mathematical way in which Value at Risk is computed [2], as well as its effects on the economy [3], VaR methods remain the main tools in measuring market risk. Firstly, they provide the whole amount of market risk at which a bank is exposed with its positions, secondly, their estimates are transposed in a capital charge to provide a careful watch at the possible losses arising from adverse market conditions and finally they are subject to possible validation tests i.e. back-testing.

This paper is of particular interest as it represents one of the few studies emphasizing on market risk measurement on the Romanian banking sector. Additionally, this paper has a major contribution to the existing literature because of the new perspective of testing whether there is a relationship between the value at risk of a bank and the value at risk of the market index.

### 3. Data collection and methodology

The sample includes four banks in Romania: Erste Bank Romania (EBS), BRD-Groupe Société Générale (BRD), Transilvania Bank (TLV) and Carpatica Bank (BCC). The study focuses on the largest domestic banks for two main reasons: first, these are the Romanian banks that are listed in the main section of Bucharest Stock Exchange (BSE). Secondly, these four banks represent almost half of the total net assets from the Romanian banking sector. Our main analysis is applied on the bank with the highest market value, Erste Bank Romania.

The data for the bank sample are based on the individual bank stock returns which were required from Datastream. Furthermore, the data for Romanian general market index BET were acquired from Bucharest Stock Exchange official site.

For this study we will analyze 500 daily stock prices from February 2008 until

February 2010. We have chosen this time horizon considering previous studies ([1], [5], [7]) which have based their analysis for computing VaR also on 500 trading days.

Throughout the analysis we have considered daily VaR estimates and a confidence interval of 99%, according to literature review.

In order to determine VaR, we have used the Historical Simulation (HS-VaR) model. This is the standard industry practice for calculation of VaR ([5], [10]). The model generates risk factor scenarios from the empirical distribution arising from historical series of past market factor changes [12].

Therefore, our methodology can be described as follows: we first test the normality of the stock returns of the four banks and then apply the historical simulation method in order to find the VaR at a 99% level of confidence. After computing the values at risk for the four banks, as well as for the market index BET, we estimate a regression equation in order to test if the VaR of BET index influences the VaRs of the analyzed banks.

$$VaR_{name_{of\_bank}} = \alpha_0 + \alpha_1 * VaR_{BET} \quad (1)$$

The hypothesis that we want to test using the regression equation (1) can be statistically formulated as follows:

$$\begin{cases} H_0: & \alpha_1 = 0 \\ H_1: & \alpha_1 \neq 0 \end{cases}$$

The remainder of the paper will follow these steps, present and critically analyze the outcome of the study.

#### 4. Data analysis

The process of analyzing our results starts with presenting some characteristics of the distribution of returns for each of the banks. In order to choose between the variance-covariance approach and the historical simulation method, we need to know if the returns are normally or not normally distributed around their means. As can be noticed in Table no.1, the probability associated with the Jarque Bera Test is smaller than 0.05, which means that it is statistically significant at the level of 5% and that the hypothesis regarding the normality is rejected.

Table 1: Testing for the normality of the returns

	ESB	BCC	TLV	BRD	BET
Skewness	-0.548	-0.130	-12.662	-0.395	-0.282
Kurtosis	6.364	9.363	254.888	6.191	5.526
Jarque-Bera	260.344	843.280	1332.556	224.725	139.304
P-value	0.000	0.000	0.000	0.000	0.000

Source: author's computations

Therefore, the returns are not normally distributed and this leads us to the conclusion that the method applicable in our case is that of historical simulations.

Having established the method that we will use, we now compute the values at risk for each of the four banks, as well as for the market index, BET. Table no.2 presents the results of these VaRs.

Being computed at a 99% confidence level, these values are equal to the six most negative changes in the market stock prices of each bank. Considering 500 daily trading, the loss encountered by the banks would be higher than the identified one in just 5 out of 500 cases.

It is important to say that VaR measures of BET, ESB, BCC, TLV and BRD take into consideration also the sensitivity of the market. A higher value of VaR (in our case BET and EBS) indicates that these positions are sensitive to different market factors, while lower values of VaR show that these positions have a lower sensitivity to market factors. Of course, these lower values could also be the effect of the degree of liquidity of the individual position. This last statement represents in fact a limit of the data collection and methodology presented in this paper.

Taking into consideration the literature review, we aim to compute the value at risk at a 99% confidence level, as the Bank for International Settlement, because this interval is the one required by the banking regulator and it is more appropriate for measuring market equity risk. Besides this, the confidence level of 95% used by the model of J.P. Morgan is more adequate for measuring credit risk.

Comparing the VaR of the four banks, it can be noticed that Erste Bank has the higher value at risk (17.20), followed by BRD-Groupe Société Générale (1.62), Transilvania Bank (0.10) and Carpatica Bank (0.01), respectively. Due to the higher exposure of

Erste Bank Romania on the market, its position has a great sensitivity to the market factors, compared with the other banks. These results are presented in Table no.2

Table 2: VaR computed at the 99% confidence level

VaR_ BET	VaR_ EBS	VaR_ BCC	VaR_ TLV	VaR_ BRD
-394.2	-17.20	-0.01	-0.10	-1.62

Source: author's computations

Regarding the relationship between the VaR of the analyzed banks and the VaR of the market index, we have estimated the regression equation (1) between the two variables in order to find if there exists a connection between them. The results of the regression are presented in Table no.3.

Table 3: Estimated values and associated p-values for VaR\_BET in regression with the VaR of each bank

	VaR_ ESB	VaR_ BCC	VaR_ TLV	VaR_B RD
$\alpha_1$	0.035	0.000	0.000	0.003
p-value	0.000	0.000	0.000	0.000

Source: author's computations

As presented in Table no.3, the estimated value for the coefficient of the variable VaR\_BET has an associated probability of 0.000, which is lower than 0.05. This means that it is statistically significant and we reject the null hypothesis. Therefore, we can state that the value at risk of the market index influences the value at risk of the analyzed banks. The estimated value of the coefficient measures the impact that VaR\_BET has on the VaR of each bank.

As can be observed in Table no. 3, the estimated values for the coefficients of the value at risk for each of the four banks are all positive. This leads to the conclusion that the VaR of the market index BET positively influence the VaRs of the banks. For example, if the bank would enter into a LONG position on an option based on the market index BET and a LONG position in its own stock, a change in the value at risk of the option will determine a positive change in the value at risk of the respective bank.

Additionally, due to the fact the coefficient for the value at risk of market

index BET is higher in case of Erste Bank than in case of the other banks, it means that when there is a movement in the VaR of the market index, its impact is higher in case of Erste Bank than in case of the other three banks. The relationships between VaR of the market index and VaRs of each bank are presented in Figures A6-A9.

Moreover, the smallest impact can be noticed in case of the VaR of Carpatica Bank. The differences in the level of this impact can be explained by the fact that Erste Bank has a higher exposure on the market compared to the other banks, followed by BRD-Groupe Société Générale, Transilvania Bank and Carpatica Bank.

As a conclusion for our analysis it can be stated that our hypothesis regarding the relationship between the value at risk of the analyzed banks and the value at risk of the market index BET cannot be rejected.

## 5. Conclusion

Computing and analyzing the values at risk of Erste Bank Romania compared with other three banks from the Romanian banking system, we wanted to measure and compare the market equity risk for the most important banks from the Romanian banking system using one of the most popular methods, named historical simulations. Moreover, we wanted to test whether the VaR of the market index BET influences the VaR of the banks.

To sum up the results of our analysis, we can conclude that the VaR of Erste Bank Romania, as well as those of the peer banks are decreasing as their market exposure decreases. Also, our findings confirm the fact that the VaR of the market index BET positively influences the VaR of each of the banks.

At this point we can state that our analysis may represent a starting point for a further analysis on comparing post and ex ante crisis period regarding the measurement of bank risk. Also, our paper is important in the context of market risk as a component of systemic risk.

## 6. Acknowledgement

This work was cofinanced from the European Social Fund through Sectoral Operational Programme Human Resources Development 2007-2013, project number POSDRU/187/1.5/S/155656 „Help for doctoral researchers in economic sciences in Romania”.

## 7. References

- [1] Aramonte, S., Rodriguez, M., Wu, J., ” Dynamic Factor Value-at-Risk for Large Heteroskedastic Portfolios”, *Journal of Banking and Finance*, 37(11), 2013, 4299 – 4309.
- [2] Artzner, Ph., F. Delbaen, J.-M. Eber, and D. Heath, ”Coherent Risk Measures”, *Mathematical Finance* 9, 2011, pp. 203-228.
- [3] Basak, S., Shapiro, A.,”Value-at-risk-based risk management: optimal policies and asset prices”, *Review of Financial Studies* 14, 2001, pp. 371-405.
- [4] Beder, D.S.,”VaR: Seductive but Dangerous”, *Financial Analyst Journal*, September/October 1995, 12-24.
- [5] Berkowitz, J., O’Brien, J., ”How Accurate are Value-at-Risk Models at Commercial Banks?”, *Journal of Finance* 57(3), 2001, 1093-1111.
- [6] Cassidy, C., Gizycki, M.,”Measuring traded market risk: Value-at-Risk and backtesting techniques”, *Working Paper*, 1997, Reserve Bank of Australia.
- [7] Christoffersen, P., Pelletier, D., ”Backtesting Value-at-Risk: A Duration-Based Approach”, *Journal of Financial Econometrics*, 2(1), 2004, 84—108.
- [8] Lucas, A., ”An evaluation of the Basle guidelines for backtesting banks’ internal risk management models”, *Journal of Money, Credit and Banking* 33, 2001, 826–846.
- [9] Perignon, C., Smith, D.R.,”The level and quality of Value-at-Risk disclosure by commercial banks”, *Journal of Banking and Finance*, 34, 2010, 362-377.
- [10] Perignon, C., Smith, D.,”Diversification and Value-at-Risk”, *Journal of Banking & Finance* 34, 2010, 55-66.
- [11] Pyle, D.H., ”Bank Risk Management: Theory”, Paper presented at the Conference on Risk Management and Regulation in Banking, 1997, 17-19.
- [12] Resti, A., Sironi, A.,”Risk Management and Shareholder’s Value in Banking. From Risk Measurement to Capital Allocation Policies”, 2007, John Wiley & Sons. Ltd.



# The Impact of Accounting and Fiscal Regulations on Corporate Income Tax Information Provided to Stakeholders

Nicu Popa

*Bucharest University of Economic Studies*

[popanicu@gmail.com](mailto:popanicu@gmail.com)

Adriana Florina Popa

*Bucharest University of Economic Studies*

[adriana.fp@gmail.com](mailto:adriana.fp@gmail.com)

## Abstract

*In an unstable and uncertain current economic context, taxation plays an important role especially in countries where an acceleration of fiscal consolidation is attempted. Moreover, analyzed from the internal market point of view, taxation is responsible for shortages and prevents economic operators to make full use of their resources. The company reports financial performance that the tax authorities do not always accept, considering the company to be more or less efficient than reported. This informational asymmetry is due to the expectations of end users of accounting information whose interests are different. Despite the significance of the corporate income tax in relation to the result, information provided by financial statements is one of the least understood. Our intention is to determine whether the changes have impact on the information reporting needs of all interested parties in terms of result and corporate income tax in Romania.*

**Keywords:** information, stakeholders, result, corporate tax, tax regulations

**J.E.L. classification:** M41, H25

## 1. Introduction

There have been significant changes in the tax environment worldwide over the last years, leading to an increased need of effective communication in terms of fiscal information for the stakeholders. In general, the stakeholders are present and potential investors, lenders, suppliers and other trade creditors, customers, governments and their

agencies, employees and the general public. All of these categories of users rely on information provided by the company to help them in decision-making. The financial statements are the main source of information, but they cannot provide all the information needed. In particular, from the taxation point of view, the key stakeholders can be illustrated as follows:

Figure 1: Key Stakeholders in Tax

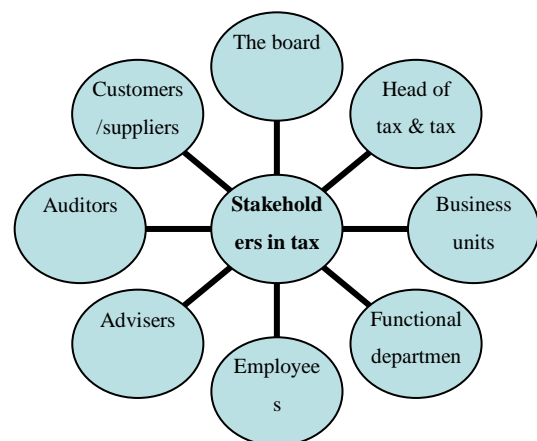

Source: [1]

There is a grown interest nowadays, in the corporate taxes, seen as the contribution of the company of its own profit to the economy and, in the same time, a key dimension in building the trust of its stakeholders [2].

Table 1. Diagram of Interest of Stakeholders

Investors	<ul style="list-style-type: none"> <li>• Clarity on tax risk position</li> <li>• Year on year stability of tax charge</li> <li>• Understanding likelihood for deferred tax to materialize</li> </ul>
-----------	--

Board	<ul style="list-style-type: none"> <li>• Management of tax risk including reputation risk</li> <li>• Ethical business practices</li> </ul>
Consumers	<ul style="list-style-type: none"> <li>• Reduced sales taxes</li> </ul>
Tax	<ul style="list-style-type: none"> <li>• Tax compliance</li> <li>• Building trusted relationship with HMRC</li> </ul>
Finance	<ul style="list-style-type: none"> <li>• Reduced tax costs</li> <li>• Achievement of financial targets</li> </ul>
Governments	<ul style="list-style-type: none"> <li>• Maximizing corporate tax</li> <li>• Attracting and retaining investment</li> <li>• Financing public services</li> </ul>
External affairs/CR	<ul style="list-style-type: none"> <li>• Avoiding negative press on anti-avoidance</li> <li>• Alignment of business principles with tax practices</li> </ul>
NGOs	<ul style="list-style-type: none"> <li>• Campaigning against tax avoidance</li> <li>• Asking companies to pay a fair contribution in all countries of operation</li> <li>• Combating 'capital flight'</li> </ul>

Source: Landolf, U, Symons, S. [3]

In our paper, we focused on the interest given by stakeholders to information on result and its taxation in the current context, characterized by the tendency of convergence of accounting standards internationally, as a result of the process of economic globalization, especially of financial markets that give rise to requirements for comparability of financial statements.

## 2. Literature Review

Prior research has explored the connection between financial and tax reporting in the attempt to adapt to the informational needs of various types of stakeholders.

The main source of information about a company is provided by its set of financial statements, in a narrower sense, or the annual report, in a larger sense. Lee (2006) considers that one of its greatest strengths is that it satisfies many needs, while the major weakness is that it became a package of statements that may not completely fulfill the needs of any specific stakeholder group, including shareholders [4].

As demand for clear, accurate and timely tax information has increased during the past several years, shareholders now expect to receive more information on their company's tax policy than they have in the past [5]. There are analysts that encourage the investors to ask more questions in relation to effective tax rates [6]. Furthermore, information about the fiscal obligations can provide an explicit overview of their cost, ways of improving their governance, understand the role of the taxes in managing cash or payments directly made to tax authorities. In contrast, recent trends highlight that firms do not always trade off financial and tax reporting decisions and, in fact, some firms may be reporting higher accounting profit to shareholders and lower taxable result to fiscal authorities [7].

Cunningham (2008) draw attention on the fact that tax authorities are more and more aggressive around the world, while doing their best to make sure that companies are following the rules. Moreover, other regulators, such as accounting standards organizations, with rules such as the Sarbanes-Oxley Act and FASB Interpretation 48 *Accounting for Uncertainty in Income Taxes*, have ensured that the relationship between taxation and accounting has taken on an importance for the rest of the business that it may not have had [8].

An extensive empirical literature explored the interaction of accounting and taxation ([9], [10], [11], [12], [13]). There are authors concerned on the connection between accounting and corporate result taxation ([14], [15], [16]).

As shown in a PWC article in 2010, despite the fact that the corporate profit tax expense can be significant – perhaps a third of the annual profits, the tax in the financial statements is one of the least understood areas of financial reporting. Tax reporting is more than the money the company expects to pay to the state. Feedback from discussions with analysts on how companies report their tax indicates four key areas where they would like to see enhanced disclosures: tax rate reconciliation, cash tax, deferred tax reversal and tax expense in relation items [17].

### 3. Trends in the relation between accounting and taxation in terms of result

In theory, accounting and taxation have as a common objective the research of the result. The specific concerns of the two disciplines often lead to application of different and, sometimes, contradictory rules. Taxing profits is one of the most debated issues in accounting, because in most countries the rules for measuring and recording the accounting and fiscal results were achieved based on different objectives. While the accounting result reflects the application of accounting principles and an accurate measurement of the activity, the fiscal result reveals the interests of the tax authority. The taxable base differs on the accounting model adopted, as the latter is a starting point for computing the first.

The accounting rules that cover corporate income tax require only disclosure of amounts payable or receivable in the balance sheet and of expenses in the income statement. As a difference from the US GAAP approach, there is no guidance on reporting the uncertain tax positions in the IFRS. There are no specific requirements on indirect taxes either.

The two important bodies – IASB (International Accounting Standards Board) and FASB (Financial Accounting Standards Board), assigned an important part to the accounting treatment of corporate income tax, through standards IAS 12 *Income Taxes* and SFAS 109 *Accounting for Income Taxes*. The two regulations were also supported over the period and by taxation, through debates on account of harmonizing corporation tax at the European level, an initiative that started in 1962 by the Neumark Report, as a result of the provisions of the Treaty of Rome (1957).

In 2001, a process of achieving a common consolidated tax base (CCCTB) has started [18]. The main objective of this initiative was to align the tax treatment at the group level, to provide an effective disclosure of information between its members, nationally and internationally. It has also got involved in the attempt to standardize the relationship between accounting and taxation. This draft directive aimed at a unitary computation of the taxable base, on common rules, followed by profit distribution among the states, which

keep their right to set their own corporate tax rates.

A debate on the use of the IFRS referential as a starting point in determining the consolidated tax base has been launched in 2003 by the European Commission, without the intention of a complete takeover of its accounting provisions. The idea of using this international referential has been supported mainly by the fact that they provide common language and definitions. The elements of those standards, which are not consistent with the treatment of CCCTB, are not imported and, thus, they will not have a direct formal link with the constant changes in standards [19].

Among the arguments in favor of IFRS implementation, there are the increased comparability and the relevance of financial information [20]. Given the complexity of the problems that arise in creating and applying rules for the taxable base, achieving a directive covering every detail would be very difficult to achieve. Therefore, there are many authors who support the use of IFRS as a starting point in determining the profit, taking into account possible deviations for tax purposes, which should be explicit and based on of autonomous fiscal principles [21].

For those applying IFRS (similar to US GAAP), income tax positions are assessed under two different approaches at interim closing and at year-end. IAS 12 requires the full balance sheet liability method to be used for annual financial statements, whereas the projected effective tax rate (ETR) must be used for interim closing. Usually, the ETR is computed as the ratio of total corporate profit tax expense to accounting result before tax. It reflects permanent accounting tax differences and other statutory adjustments included in the rate reconciliation schedule of a firm [22]. These requirements entail significant changes in a group's working process depending on which is at stake and on the considered period (quarter or full year) [23].

Analysis of the research carried out by some organizations, indicates that current disclosures under IAS 12 are not sufficiently complete to allow inferences of taxable income or tax payments (tax cash flows) by the users of financial statements [24]. Although the provision of information in the notes, beyond that required by IAS 12 is

likely to be relevant to users, supplying such information comes at a cost to preparers. The IASB framework states that information should only be required if the benefits of reporting the information outweigh the costs.

There were some attempts from the European Financial Reporting Advisory Group (EFRAG) in a discussion paper issued in 2013 to identify if the users of financial statements would prefer additional disclosures on income taxes. The paper focused on receiving feedback on the accounting for corporate income tax and on whether future efforts should be focused on improving IAS 12 and retaining its basic principles or developing a new approach based on different principles. Most respondents disagreed with disclosure of information about the tax strategies or the uncertain position as this type of information was considered to be sensitive [25].

#### 4. Impact of changes in accounting and fiscal regulations in terms of corporate income tax. An analysis on Romania' case

The Romanian accounting system faces a continuous reform process started many years ago, in an attempt to align the relevant legal provisions from Romania to the ones of European Union, as well as to the International Financial Reporting Standards. This process can be synthesized as follows:

1992-present	Accounting Law no. 82/1991 with its numerous subsequent amendments and additions
1994	Adoption of a new accounting system closer to the French system, based on the general accepted accounting principles (GAAP)
1999 - 2001	Order no. 403/1999 for the approval of accounting regulations harmonized with the 4th Directive of the European Economic Community and the IAS
2001-2005	Order no. 94/2001 regarding the approval of the Accounting Standards compliant with the 4th Directive of the European Community and IAS
2002-2005	Order no. 306/2002 for the approval of the simplified Accounting Standards, harmonized with the European Directives

2006-2009	OMFP no. 1752/2005 regarding the approval of the accounting regulations compliant with European Directives
2010-2014	Order no. 3055/2009 regarding the approval of the accounting regulations compliant with the 4th Directive of the European Union for the individual financial situations and with the 7th Directive of the European Union for the consolidated financial situations
2012-present	Order no. 1286/2012 for the approval of the accounting regulations compliant with the International Financial Reporting Standards
2015	Order no. 1802/2014 for the approval of the accounting regulations on the individual and consolidated annual financial statements

Along with the Romanian accounting system, the fiscal one also has experienced many changes in rules and attempts of stability. Starting 2016, a new fiscal code will be in force, annulling the former one adopted in 2003.

The current profit tax method is used according to the fiscal rules. This method considers the accounting expense of the year as the sum of the taxes payable in the financial year in question. A possible incidence of temporary differences is stated in the balance sheet. This method is generally used in countries where accounting is strongly connected to taxation. It is also the case of Romania, where there is only one result of the year, an accounting balance sheet for own information needs, as well as of other parties and no fiscal balance sheet designed for the tax authorities. Therefore, to obtain taxable income requires some processing of elements like non-taxable income, non-deductible expenses, tax deductions or similar items of revenue and expenses.

Introducing quarterly prepayments method as an option starting 2013 has the advantage of facilitating the computation of income tax and quarterly monitoring of the reported amounts. This decision could prove its effectiveness if an increase in taxable

results is expected for at least the next two years, otherwise the company will report and pay a higher amount. This situation could lead to a profit tax claim against the state at the end of the fiscal year. As in the Romanian fiscal system recovery of overpaid sums is difficult to achieve, the company is in a position to have cash blocked to the state's disposal.

Another attempt of improving the quality of information provided to stakeholders was the possibility of companies having the financial year different from calendar one, to adopt their fiscal year for the same period, firstly introduced for subsidiaries belonging to foreign groups in 2012 and then for all companies, starting 2014.

The adoption of IFRS starting 2012 by the companies with securities admitted to trading on a regulated market implies the usage of taxation methods normalized by the international referential. In order to establish the connections between the accounting and the fiscal result, the practice in the field identified the deferred tax method. The objective of true and fair view requires taking into account the temporary differences arising between the tax and accounting (economic) treatment of the same operation, and not only the permanent ones.

The debates that have always existed on deferred taxes show the importance given to them in terms of financial reporting. The practice of multinational companies, which dedicate them notes to the financial statements, usually quite bulky ones, only come to support the idea that deferred taxes provide information necessary for an accurate reporting.

The deferred tax method treats the allocation of deferred tax expense on income tax, by accounting recognition of temporary differences. Corporate income tax expense is recorded even if it is not equal to the tax due to the state budget, the latter being determined in accordance with fiscal rules.

The recognition and disclosure of deferred tax in the income statement and balance sheet are carried out as a separate position from the current tax.

The evaluation of deferred tax assets and liabilities reflects the tax consequences that would follow from the manner in which the company expects, at the balance sheet date, to recover or settle the carrying amount of its

assets and liabilities. Current tax assets and liabilities for the current and prior periods are measured at the amount expected to be recovered or paid to the taxation authorities, using regulated tax rates.

In many countries, accounting for deferred taxes is not mandatory at the level of individual accounts. Taking into account the share of the amounts involved, the result and financial position of an enterprise may be very different, as the latent tax items may or may not be considered. Along with recourse to accounting for deferred taxes, their balances from previous years are adjusted yearly to take into account the rates change or new taxes. For a company seeking to increase its earnings or net asset this method is beneficial in case of taxes increase. Businesses will thus choose their financial strategy based on taxation development. Any change in the method that is not required by regulations development may, therefore, be interpreted as an attempt to manipulate the results [26].

## 5. Conclusions

International cooperation is essential to avoid both double taxation and double "non-taxation" of the same income, as well as to achieve a balance between the need for budgetary resources of a country and for attracting foreign investors. In a fiscal perspective, the notion of the common tax base received a favorable agreement. There are opinions that claim that IFRS could provide a neutral starting point around which a debate on the tax base would be articulated.

In view of a correct IFRS implementation a disconnection between accounting profit and tax should be accomplished, or if it already exists, the fiscal rules have to be adjusted to reduce the differences between national standards and the international ones. Fiscal legislation, through tax harmonization and concerns about the development of a common consolidated tax base, is a very important area. Together with international accounting regulations, it can reduce the influence between accounting and taxation.

A number of arguments is brought in favor of the current profit tax method. Thus, the profit tax is determined according to laws, different from country to country, and that change quite often. The profit tax is

determined based on the taxable result, and not on the accounting one. The expense calculated using the current tax is more understandable for users and less expensive. The profit tax actually paid is the best basis for forecasting cash flows as deferred taxes cannot be paid only over a long period of time or at all.

Nevertheless, several considerations are formulated in favor of applying the deferred tax method:

- The corporate income tax is a cost of any business, computed based on the result. It is normal for all expenses to have the same accounting principles. Eventually, all temporary differences are reabsorbed and their fiscal effects are accounted for in the period in which transactions that caused these differences occurred and tax payments are made.
- If the corporate income tax is not accounted based on the deferred tax method, the net result will fluctuate in relation with the temporary differences, which would result in greater difficulty in forecasting profits and cash flows.
- Deferred tax assets and liabilities are consistent with the definitions of IASB and FASB conceptual accounting frameworks.

The recognition of a deferred tax recognition is a prudent approach of the company, which would rather allocate the fiscal cost on the lifetime of the asset. Moreover, accounting for a deferred tax, will lead to the creation of a financing source of a future tax. The following year there is the advantage that there already is a source of funding by recording it in the previous year.

Despite the national fiscal regulation, we believe that a separation of the tax in a part related to the current year and another one for the year then next is useful because it allows a "look into the future" and warns or announces the company about its income tax payments (debt) or receipts (receivables). It is actually an allocation of the tax effects in time, the same as income and expenses are distributed over the periods in which they result.

We share the opinion according to which an effective international harmonization of accounting and taxation rules in terms of

result would improve communication with all interested users.

## 6. Acknowledgments

This paper was co-financed from the European Social Fund, through the Sectorial Operational Program Human Resources Development 2007-2013, contract POSDRU/187/1.5/S/155463 "Supporting excellence in scientific interdisciplinary doctoral research in the economic, medical and social fields", coordinator The Bucharest University of Economic Studies

## 7. References

- [1] Cox, T., "Stakeholders Communications". Tax Management in Companies, International Tax Review, 2nd Edition No. 44, 2008, [http://www.pwc.com/gx/en/tax-management-strategy/pdf/pwc\\_tax\\_management\\_in\\_companies.pdf](http://www.pwc.com/gx/en/tax-management-strategy/pdf/pwc_tax_management_in_companies.pdf)
- [2], [6] Ernst&Young, "Tax Transparency-Seizing the initiative", Ernst&Young LLP, 2013, UK, [http://www.ey.com/Publication/vwLUAssets/Tax\\_Transparency\\_-\\_Seizing\\_the\\_initiative/\\$FILE/EY\\_Tax\\_Transparency.pdf](http://www.ey.com/Publication/vwLUAssets/Tax_Transparency_-_Seizing_the_initiative/$FILE/EY_Tax_Transparency.pdf)
- [3] Landolf, U., Symons, S., "Applying corporate responsibility to tax", Tax Management in Companies, International Tax Review 2nd Edition No. 44, 2008, [http://www.pwc.com/gx/en/tax-management-strategy/pdf/pwc\\_tax\\_management\\_in\\_companies.pdf](http://www.pwc.com/gx/en/tax-management-strategy/pdf/pwc_tax_management_in_companies.pdf)
- [4] Lee T.A. (2006) *Financial Reporting and Corporate Governance*, John Wiley&Sons Ltd., Chichester, England
- [5] KPMG, "The Rising Tide Regulation and stakeholder pressure on tax departments worldwide", 2007, <https://www.kpmg.com/ES/es/Actualidad/Novedades/Articulos/Publicaciones/Documents/TheRisingTide.pdf>
- [7], [21] Frank, M. M, Lynch, L.J., Rego, S.O., "Tax Reporting Aggressiveness and Its Relation to Aggressive Financial Reporting", 2008, [http://papers.ssrn.com/sol3/papers.cfm?abstract\\_id=647604](http://papers.ssrn.com/sol3/papers.cfm?abstract_id=647604)
- [8] Cunningham, R., "Tax Management in Companies", International Tax Review, 2nd Edition No. 44, 2008, [https://www.pwc.com/gx/en/tax-management-strategy/pdf/pwc\\_tax\\_management\\_in\\_companies.pdf](https://www.pwc.com/gx/en/tax-management-strategy/pdf/pwc_tax_management_in_companies.pdf)
- [9] Stackelford, D.A., Shevlin, T. J., "Empirical Tax Research in Accounting", 2000,

- [http://papers.ssrn.com/sol3/papers.cfm?abstract\\_id=235796](http://papers.ssrn.com/sol3/papers.cfm?abstract_id=235796)
- [10] Cloyd, C. B., Pratt, J., Stock, T., "The Use of Financial Accounting Choice to Support Aggressive Tax Positions: Public and Private Firms", *Journal of Accounting Research*, Volume 34, Issue 1, 1996
- [11] James, S., "The Relationship between Accounting and Taxation", Paper number 02/09, 2009, <https://business-school.exeter.ac.uk/documents/papers/management/2002/0209.pdf>
- [12] Alley, C., James, S., "The Interface between Financial Accounting and Tax Accounting: A Summary of Current Research", Working Papers Series No. 84, 2005, [http://researchcommons.waikato.ac.nz/bitstream/handle/10289/1681/Accounting\\_wp\\_84.pdf?sequence=1](http://researchcommons.waikato.ac.nz/bitstream/handle/10289/1681/Accounting_wp_84.pdf?sequence=1)
- [13] Cuzdriorean, D.D., Matis, D., "The Relationship between Accounting and Taxation insight the European Union: The Influence of the International Accounting Regulation", *Annales Universitatis Apulensis Series Oeconomica*, 14(1), 2012, <http://www.oeconomica.uab.ro/upload/lucrari/1420121/02.pdf>
- [14] Hanlon, M., Shevlin, T., "Book-Tax Conformity for Corporate Income: An Introduction to the Issues", *Tax Policy and the Economy*, Volume 19, James M. Poterba, editor, MIT Press, 2005, <http://www.nber.org/chapters/c0166.pdf>
- [15] Manzon, G.B. jr., Plesko, G.A., "The Relation between Financial and Tax Reporting Measures of Income", 2001, <http://web.mit.edu/gplesko/www/Manzon%20Plesko%20TLR%202002a%20Relation%20Between%20Fin%20and%20Tax.pdf>
- [16] Graham J., Raedy J., Shackelford D., "Research in Accounting for Income Taxes", Working Paper 15665, 2010, <http://www.nber.org/papers/w15665.pdf>
- [17] PWC, "Improving income tax disclosures", Investor view, 2010, [www.pwc.com/gx/en/audit-services/corporate-reporting/publications/investor-view/pdf/pwc-improving-income-tax-disclosures.pdf](http://www.pwc.com/gx/en/audit-services/corporate-reporting/publications/investor-view/pdf/pwc-improving-income-tax-disclosures.pdf)
- [18] COM(2001) 582, "Towards an Internal Market without tax obstacles - A strategy for providing companies with a consolidated corporate tax base for their EU-wide activities", [http://ec.europa.eu/prelex/detail\\_dossier\\_real.cfm?CL=en&DosId=168921](http://ec.europa.eu/prelex/detail_dossier_real.cfm?CL=en&DosId=168921)
- [19] COM (2006) 157, "Implementing the Community Lisbon Program: Progress to date and next steps towards a Common Consolidated Corporate Tax Base (CCCTB)", [http://ec.europa.eu/prelex/detail\\_dossier\\_print.cfm?CL=en&DosID=194089](http://ec.europa.eu/prelex/detail_dossier_print.cfm?CL=en&DosID=194089)
- [20] Clarkson, P., Hanna, D., Richardson, R., Thompson, R., "The impact of IFRS adoption on the value relevance of book value and earnings", 2011, [http://www.af.polyu.edu.hk/jcae\\_af/2010/paper\\_p/Session%206.pdf](http://www.af.polyu.edu.hk/jcae_af/2010/paper_p/Session%206.pdf)
- [22] Freedman, J., Macdonald, G., "The Tax Base For CCCTB: The Role Of Principles", Vienna University of Economics and Business Administration, February, WP 08/07, 2008, [www.sbs.ox.ac.uk/centrestax/Documents/working\\_papers/WP0807.pdf](http://www.sbs.ox.ac.uk/centrestax/Documents/working_papers/WP0807.pdf)
- [23] Morgant, T., "Process or technology?", *Tax Management in Companies*, International Tax Review, 2nd Edition No. 44, 2008, [http://www.pwc.com/gx/en/tax-management-strategy/pdf/pwc\\_tax\\_management\\_in\\_companies.pdf](http://www.pwc.com/gx/en/tax-management-strategy/pdf/pwc_tax_management_in_companies.pdf)
- [24] EFRAG, "Improving the Financial Reporting of Income Tax Discussion Paper", 2011, [http://www.efrag.org/files/ProjectDocuments/Proactive%20-%20Income%20Taxes/120127\\_Income\\_tax\\_DP\\_final.pdf](http://www.efrag.org/files/ProjectDocuments/Proactive%20-%20Income%20Taxes/120127_Income_tax_DP_final.pdf)
- [25] EFRAG, "Improving the Financial Reporting of Income Tax. Feedback Statement", February 2013, [http://www.efrag.org/files/ProjectDocuments/Proactive%20-%20Income%20Taxes/130208\\_Income\\_Tax\\_Feedback\\_Statement.pdf](http://www.efrag.org/files/ProjectDocuments/Proactive%20-%20Income%20Taxes/130208_Income_Tax_Feedback_Statement.pdf)
- [26] Feleagă, N., "*Sisteme contabile comparate*", Ed. Economică, București, 1999

## Financing of the EU SMEs by the Capital Markets: An Overview

Angela Roman

“Alexandru Ioan Cuza” University of Iasi

[aboariu@uaic.ro](mailto:aboariu@uaic.ro)

Valentina Diana Rusu

Department of Interdisciplinary Research – Human and Social, “Alexandru Ioan Cuza”

University of Iasi

[valentinadiana.ig@gmail.com](mailto:valentinadiana.ig@gmail.com)

### Abstract

*Improving access to finance for SMEs by promoting the development of alternative non-banking financing channels represents in the current context a highly debated topic by European and national authorities, and academics. This paper discusses the possibility of EU28 SMEs financing through the capital markets, highlighting the difficulties faced by SMEs when seeking to obtain finance in these markets, but also the funding opportunities based on the market that have emerged in recent years.*

*Furthermore, our study highlights the main recent EU initiatives used to develop alternative sources for SMEs financing, which are intended to complement bank lending.*

*By its content, our paper emphasizes the need to promote and develop of market-based financing instruments in order to reduce excessive dependence of SMEs by banks, but also to strengthen the resilience of real economy to shocks and banking crises.*

**Key words:** SMEs financing, bank lending, alternative financing, capital markets

**J.E.L. classification:** O16, G21, G23

### 1. Introduction

Easy access to appropriate finance is crucial for the creation, survival and growth of SMEs. However, in the context of the recent financial crisis and economic recession, the access to finance for SMEs has been severely affected.

In the most EU Member States, borrowing from banks is the dominant source of debt

financing for enterprises and in particular for SMEs. The significant dependence of European SMEs on bank financing and limited access to capital markets has led these enterprises to be severely affected in the context of the severe contraction of bank lending in recent years. Thus, the promotion of capital markets for SMEs and the development of other alternative financing channels, complementing the bank lending would have an important role in supporting SME financing.

Our paper discusses some key issues concerning the possibility of EU28 SMEs financing through the capital markets, and highlights the need to promote alternative channels complementary to bank financing to facilitate access to finance for these enterprises.

The remainder of this study is structured as follows: section 2 provides an overview of SMEs financing sources in EU28; section 3 focuses on SME access to capital markets, highlighting the advantages and difficulties faced by SMEs when seeking to obtain financing in these markets and also funding opportunities based on market reported in recent years. The paper ends with conclusions.

### 2. Financing sources for SMEs

Financing sources of SMEs depend on the stage of development of the enterprise and a key issue for SME financing is represented by facilitating the transition from start-up to SME to mid-cap, as evidenced by the so-called „funding escalator” (see figure 1). As SMEs are developing, they resort to various funding sources, which include bank loans, external equity from business angels, venture capital (VC), private equity funds and



ultimately the capital markets. In some stages of their life cycle, particularly in the early stage and at the growth stage, SMEs face

„financing gaps”, which are mainly due to the limited availability of non-bank sources of financing.

Figure 1. Funding escalator for SMEs

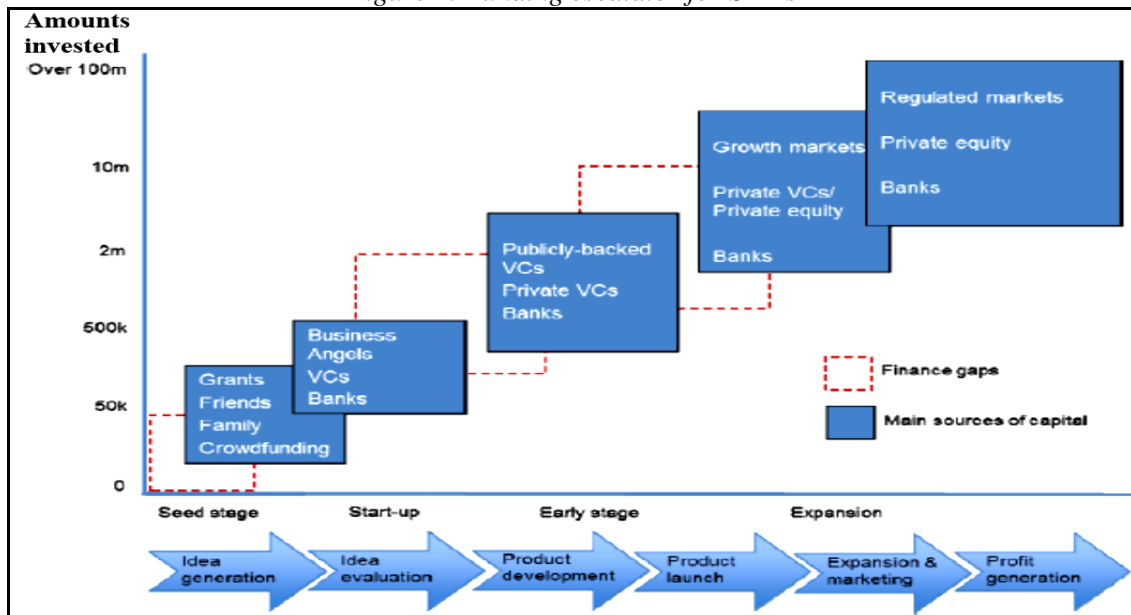

Source: [1]

The Survey on the Access to Finance of Enterprises (SAFE) conducted by the European Central Bank and the European Commission indicates that bank-related products represent the financing sources most relevant to SMEs in the EU28 compared to market-based products [2]. Thus, in 2015, more than half of EU28 SMEs have mentioned credit line or overdraft and bank loans as being the external financing sources

most relevant (see figure 2). In comparison, equity, factoring, other sources of financing and debt securities are mentioned as relevant by less than 20% of the SMEs. Also, the SAFE report shows that in 2015, 86% of SMEs in the EU28 consider at least one type of debt financing to be relevant. This aspect highlights that SMEs prefer debt financing versus equity financing.

Figure 2. SME financing sources in EU28, in 2015 (% enterprises)

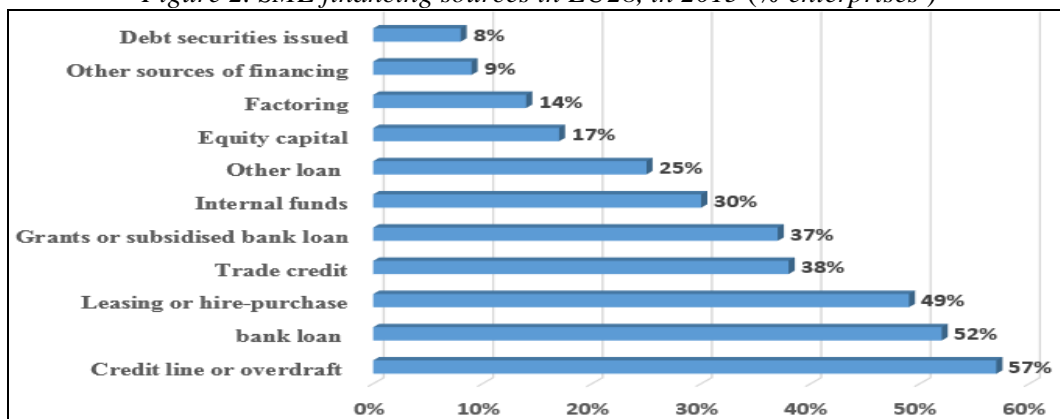

Source: [2]

The significant dependence of the enterprises, especially SMEs, on bank financing and limited access to alternative

sources of finance determines that these businesses to be extremely vulnerable under the conditions of a severe contraction of the bank lending, situation that became evident

in the context of the current global crisis. SMEs are largely relying on bank loans to finance their needs rather than capital markets. However, the current crisis has had a major negative impact on the access to bank loans, which has become more challenging because of bank deleveraging, reduced lending and tighter lending criteria requested by the banks. In this context, given the vital importance of the SME sector for the European economy, including for its relaunch, was necessary to intensify the concerns of policy makers to adopt measures to revive bank lending to enterprises, especially for SMEs and enhance the ability of banks to take risks [3].

Such measures relate to the development

of alternative sources of enterprise financing (capital market development as an alternative to bank lending, the securitisation revival, credit guarantee schemes development) to facilitate a more efficient allocation of risks and mitigate the credit constraints and also the initiation of actions to solve the problem of non-performing bank loans.

### 3. SME's Access to capital markets

Financing of EU enterprises relies significantly on bank credit, similar to Japanese enterprises while American enterprises rely more on equity financing, corporate bonds and securitisation (see figure 3).

Figure 3. Size of financial intermediation to the non-financial corporate sector (% of GDP)

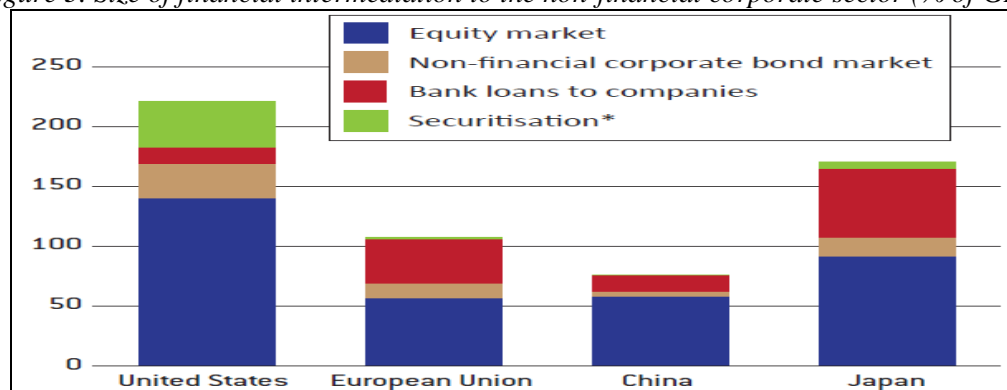

Source: [4, p. 4]

Capital markets are a good alternative to bank lending, and the listing of an enterprise on the capital market has some important advantages, including [5, p. 23]:

- It offers a better access to the capital needed for growth and development.
- Higher visibility and notoriety in the market which will generate an improved enterprise image, but also business increase and greater assurance among the enterprise's customers and suppliers.
- The possibility of attracting new partners due to increased enterprise transparency.
- Improved management efficiency and information flow as a result of improved corporate governance.
- Sustaining employee motivation and loyalty by offering stock option programs.
- Facilitation of the access to other financing sources besides raising funds from capital markets after listing by issuing new

securities, because as the business grows the investors are often interested to provide follow-up financing.

With all these advantages, the share of financing of SMEs via capital markets is currently very low in Europe and Japan compared to the United States (for example, through the equity issuance, see figure 4), although a certain number of organized exchanges and platforms could be an attractive source of financing offering many advantages for all the participants [6, p. 16].

Although capital markets represent a viable alternative to bank lending, SMEs face a number of obstacles when they want to raise money in these markets, particularly the equity capital markets, which concern both cost burden (admission fees, advisors and broker commissions) and the bureaucratic and reporting requirements. Also, the lack of financial education on the process of listing explains in part the reluctance of SMEs to

turn to equity capital markets [6]. Thus, the SAFE report show that in 2015, equity and debt securities are mentioned as relevant funding sources only by 17% and respectively 8% of SMEs in the EU28 (see figure 2).

Capital markets solutions available to SMEs can be divided into three main categories, respectively [7]: SME equity platforms, SME debt platforms and alternate listing venues (without trading). Their significant characteristics are highlighted synthetic in table 1.

*SME-focused equity platforms* are an alternative to main listing boards on national stock exchanges. These platforms provide SMEs with the opportunity to IPO once they have become well-established and are characterized by lower listing requirements and costs to list than the main board and thus may be a viable alternative for enterprises looking for funding. SME equity platforms are considered appropriate for the SMEs of medium size given the initial cost and ongoing listing requirements most platforms demand.

Figure 4. Equity issuance in Europe, Japan and US, 2001-2014<sup>1</sup>

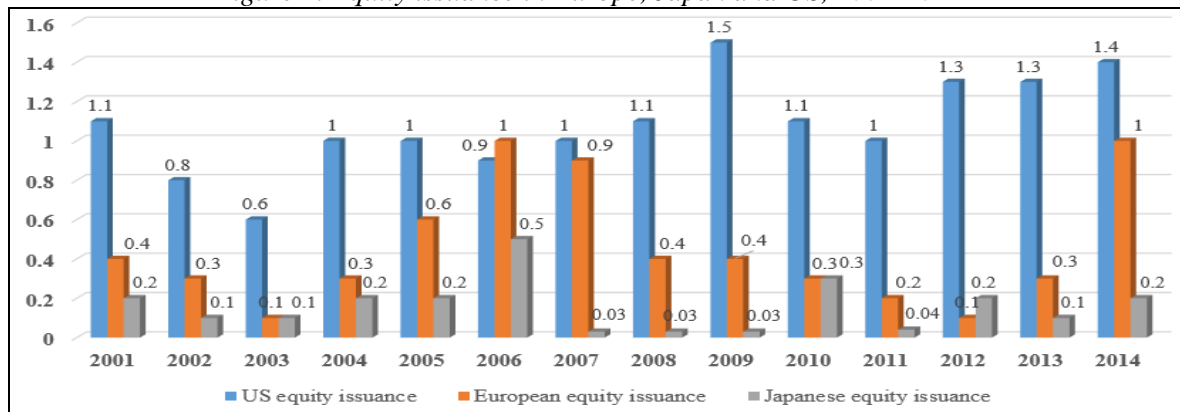

<sup>1</sup> in per cent of nominal GDP.

Source: [6, p. 16]

At European level there is a successful example of a platform for listing SMEs, named NYSE Alternext which is an equity trading market that was opened on May 17, 2005 to offer an opportunity to SMEs that need an easier access to an equity market.

The purpose of this platform was to provide listing requirements and simplified trading rules. It aims to become the reference market for small and medium enterprises throughout the Eurozone. Currently, Alternext has a total of 207 listed companies.

Table 1. Existing capital market based mechanisms for SMEs

	SME size	SME lifecycle stage	Relative cost of finance	Time to raise finance	Source of long term finance
SME Equity platforms	Medium sized SMEs (150-200 employees)	Established/mature companies	High	High	High
SME Debt platform	Medium sized SMEs (150-200 employees)	Established/mature companies	High	Medium	High
Alternative listing (without trading)	Smaller sized SMEs (<150 employees)	Developing/established companies	Low	Low	Low

Source: [7, p. 5]

Another solution is *issuing debt securities*, which is more appropriate for the

more mature and larger SMEs. The Survey on the Access to Finance of Enterprises (SAFE) indicates that in 2015 only 8% of SMEs in the EU28 resorted to issuance of

debt securities to procure financial resources (see figure 2). In recent years, in some European countries have been developed retail bond markets, for example in Germany (BondM market launched in 2010), the United Kingdom (the Order book for Retail Bonds-ORB-launched in 2010), France (the Initial Bond Offerings-IBO- launched in 2012) and Italy (ExtraMOT PRO launched in 2013). However, European equity markets are fragmented and are not sufficiently attractive for SMEs and mid-caps, being characterized by low levels of cross-border investment in securities other than blue chips. There are also major obstacles, such as different laws on securities and bankruptcy [8].

Alternate Listing Venues (without trading) platforms allow non-banking lenders and investors to lend directly to enterprises and individuals. Such venues are considered appropriate for the SMEs which are in their early development stage, but also for the small size ones. These platforms are part of crowdfunding solutions și facilitate the lending process between borrowers and investors through peer to peer (P2P), peer to business (P2B), investor to peer (B2P) or investor to business (B2B) transactions. They sustain SMEs financing by broadening the base of lenders, while providing lenders the possibility to diversify their portfolios, but also to achieve higher yield.

In order to sustain financing through capital market, in Romania, has been launched an alternative financing instruments, named AeRo. Bucharest Stock Exchange operates and manages AeRo, which is an alternative trading system. The AeRo market has been launched on February 25, 2015. It facilitates the development of companies which are accessing financing through the capital market. AeRo brings to the attention of investors the SMEs and start-ups with real potential for development, and it is dedicated to financing the enterprises that do not meet the criteria of size or age in order to be listed on the regulated market. AeRo has more relaxed listing criteria compared to the regulated market. Thus, the minimum predictive value of a company must be a minimum of 250,000 Euros compared to one million Euros requested on the regulated market, the free-float should be 10%, and the listing can be done through

private placement and not necessarily through initial public offering. The procedure of listing is simplified and the cost of listing is expressed in hundreds of lei, while, for example, on the first category the admission commission is 11.100-21.000 lei.

Improving SMEs' access to capital by developing alternative sources of non-bank financing is a central problem on the agenda of European policy makers. Thus, in March 2013 the European Commission adopted the Green paper on long-term financing of the European economy, which highlights the need to mitigate the barriers faced by SMEs on line of the access to finance through the development of non-banking alternative sources of financing, such as: venture capital, dedicated SME markets, new securitization instruments for SMEs, crowdfunding, private placement etc. [9]. It is also of interest the initiative at EU level of creation, in the multilateral trading facilities, of some specialist markets which will respond to the financing needs of these enterprises, known as SME growth markets or junior markets. By their creation, it is aimed to increase the visibility and profile of SMEs so that they become more attractive to investors and facilitate SME access to capital markets through SME growth markets [10].

An important role in helping promoting financing based on the market it has the European Commission's initiative for a capital markets union, which will provide a much greater diversification of funding sources to enterprises, reducing the cost of raising capital, particularly for SMEs and a bigger integration of capital markets. The Capital Markets Union has as main objectives [11], [12], [13]:

- *diversifying the financing channels for enterprises*, especially of small and medium enterprises *and improvement of investment opportunities*, by enhancing the role of capital markets;

- to contribute to *promoting economic growth and financial stability*. Given the important role of SMEs in the European economy by facilitating the access of these enterprises to finance the Capital Markets Union will support economic growth and the creation of jobs. Also, by diversifying the sources of enterprise financing, the Capital Markets Union will provide a risk

diversification, and thus will contribute to safeguarding financial system stability.

Increasing the role of capital markets in financing European enterprises, especially for SMEs, achieved by their easy access to debt and equity markets, would reduce the excessive dependence on banks and the real economy would console resistance to shocks and financial crises. However, such a development is lengthy and requires analysis and extensive researches on the real obstacles which hamper the development of market-based financing.

#### 4. Conclusions

In the European countries, borrowing from banks is the dominant source of external financing for SMEs. In comparison, equity, factoring, other sources of financing and debt securities have a very small share in SME financing.

Although the capital markets represent a viable alternative to bank lending, SMEs face a number of obstacles when they want to raise money from these markets. Such a situation causes the SMEs to be reluctant to financing through capital markets and thus to prefer widespread bank financing.

Significant dependence on bank financing of SMEs and limited access to capital markets has determined the fact that these enterprises to be severely damaged by the severe contraction of bank lending conditions in recent years. In this context, and given the crucial importance of SMEs for relaunching the European economy, it was necessary to focus the attention of policy makers at European level for the adoption of measures to support the financing of these enterprises through the promotion and development of other alternative financing channels, which complement bank lending.

Between the recent initiatives can be distinguished especially the European Commission's initiative for a capital markets union, which will ensure a greater diversification of financing sources for enterprises and will reduce the cost of raising capital, particularly for SMEs. The practical implementation of this initiative is lengthy and involves sustained efforts from all EU member states to eliminate barriers that hamper the development of market-based financing instruments.

#### References

- [1] European Commission, "Long-Term Financing of the European Economy", *Staff working document*, SWD (2014) 105 final, Brussels, 27.3.2014.
- [2] European Commission, "Survey on the access to finance of enterprises (SAFE). Analytical Report 2015", December, 2015.
- [3] EIB, "Unlocking Lending in Europe", European Investment Bank, 2014.
- [4] Véron N., Wolff, G.B., "Capital Markets Union: a vision for the long term", *Policy Contribution* 2015/05, Bruegel, 2015.
- [5] International Organization of Securities Commissions (IOSCO), "SME Financing Through Capital Markets", *Final Report* FR11/2015, July, 2015.
- [6] Nassr, I.K., Wehinger, G., "Opportunities and limitations of public equity markets for SMEs", *OECD Journal: Financial Market Trends*, Vol. 2015, Issue 1, October, 2015.
- [7] Peterhoff, D., Romeo, J., Calvey, P., "Towards better capital markets solutions for SME financing", Oliver Wayman – Financial Services, 2014.
- [8] European Commission, "Communication from the Commission to the European Parliament and the Council on long term financing of the European economy", COM (2014) 168 final, Brussels 27.03.2014.
- [9] European Commission, "Green Paper: Long-term financing of the European economy", COM (2013) 150 final, Brussels, 25.03.2013.
- [10] \*\*\*Directive 2014/65/EU of the European Parliament and of the Council of 15 May 2014 on markets in financial instruments and amending Directive 2002/92/EC and Directive 2011/61/EU, Official Journal of the European Union, L 173/349, 12.6.2014.
- [11] European Commission, "Green Paper. Building a Capital Markets Union", COM (2015) 63 final, Brussels, 18.2.2015.
- [12] European Commission, "Action Plan on Building a Capital Markets Union", *Staff working document*, SWD (2015) 183 final, Brussels, 30.9.2015.
- [13] PwC, "Capital Markets Union: Integration of Capital Markets in the European Union", September 2015, available at <http://marketresearchcentre.pwc.lu/market-research-centre/docs/pwc-capital-markets-union.pdf>

# The Impact of Funding Research and Development Activities through the Core Programme

Mircea-Iosif Rus

*Babeş-Bolyai University Cluj-Napoca*

*Faculty of Economic Sciences and Business Administration*

[mircearus2005@yahoo.com](mailto:mircearus2005@yahoo.com)

## Abstract

*Funding research has been, after 1989, a thorny issue in Romania. Regardless of the value of the funds allocated from the GDP for funding this activity, they proved insufficient compared to the needs for research. One solution for funding this activity is the Core Programme. This programme sought to provide a source of funding for the research activity of the National Institutes of Research and Development (INCD), especially for fundamental research. Although the value allocated from the State Budget for this activity is around 10%, we must make note of the fact that in certain research fields, the amounts allocated through this programme are essentially important. Funding through this programme represents a starting point for the respective entities, as the results obtained from fundamental research could be the basis for research agreements with economic entities in the private sector.*

**Key words:** funding, research activity, Core Programme, fundamental research, national institute of research and development.

**JEL Code:** G23, G33, O30, O32.

## 1. Introduction

The research and development activity is aimed at developing or innovating services, products and technologies, providing an optimal compatibility between the output of planning these activities (objectives, strategies, programmes and budgets) and the outputs of planning business portfolios and of strategic business, as well as with the outputs of the operational planning of the research

and development activity (projects and budgets). [1]

When choosing the research and development teams, the objectives and strategies to be followed are set, the projects needed for achieving the planned objectives and strategies are defined, the deadlines, durations of project achievement and relations between the projects are stated, and the individual or collective tasks and responsibilities needed for achieving them are defined.

## 2. The methodology of research

Throughout time, scientific research has been an object of debate in many papers, but, by analyzing these researches we may conclude that each research process contains several essential steps, in order to have a real contribution to the theoretical progress and to facilitate a better understanding of the phenomena studied by both the specialists in the field and the larger public. Thus, the essential elements of the research activity are: the field of research, the purpose of the research, the approach (the methods of research) and the results of the research.

From the beginning, this paper was intended as a **qualitative research**. Throughout the paper, we found an increasingly pressing need to expand the research with elements of **quantitative research**, meant to give greater relevance to the conclusions of the research and, at the same time, to eliminate subjective factors. The theme of this paper can be analyzed from several directions. In order to better understand the diversity of all purports which can be associated with the research and development activity, it is however appropriate to adequately know its concept, provenance and utility both theoretically and practically.

The choice of the quantitative method has been determined by the fact that this method allowed for the selection and analysis of a comprehensive bibliographic material, both national and international, represented by specialized articles and international databases, books and legislation, as well as the websites of various national and international bodies in the field of research and development.

### 3. The Core Programme

The Core Programmes are regulated by Government Decision no. 137/2003 regarding scientific research, and the manners for contracting, funding, monitoring and evaluation these programmes are regulated by Methodological Norm no. 6/2003.

This norm regulates the fact that these programmes are approved by the state authority for research and development, namely the National Authority for Scientific Research and Innovation (art. 11). These norms also provide the payment of a 30% advance of the value of the payments planned to be made under the programme (art. 16), but lately, this advanced payment has been increasingly required to be at 90%.

Also, this norm provides the fact that the value of budget funding cannot exceed 50% of the revenues of the research and development activity, but amendments to the legislation have been made and currently the value of budget funding can go up to 75% of the value of revenues of the research and development activity.

Annually, the values for the core-programmes are stipulated in the budget of the National Authority for Scientific Research and Innovation, and these values can increase or decrease following the budget revisions performed throughout a fiscal.

The value for funding the research and development activity through the Core Programme in 2009-2013 is presented in Table 1.

From the data presented in Table 1 we can observe, with the slight exception of 2013, the ascending trend for the allocation of funds through this sectoral funding program managed by the Ministry of National Education, Research

and Innovation, in order to avoid violating the legislation on state aid. If we consider 2009, the year when the current Core Programme has been launched, we can say that the allocated amount augmented: in 2010, we had a 10,79% increase, in 2011 we had a 11,28% increase, in 2012 we had a 11,67% increase, and in 2013 we had a 11,39% increase.

By comparison, Table 2 presents the value of budget funding for the research and development activity and this value's share in the total GDP value.

From the two tables, we can notice a similarity between the value of funding through the Core Programme and the total value of funding for the research and development activity, in the sense that if we take 2009 as reference, the value allocated from the budget follows an ascending trend until 2013, when the allocated value is lower than in the previous year, 2012. One explanation for this is that in 2013, construction works for the Laser on the Măgurele Platform had begun, and since this investment did not receive structural funding or FP7, the funds were allocated from the budget for research and development activities.

In respect to the share of the values allocated through the Core Programme of the total funds for research and development, we can say the following: if in 2009 this share had a value of 9,68%, in 2010 the share was 10,20%, in 2011 the share was 9,23%, in 2012 the share was 9,27% and in 2013 the share was 10,54%. Although the value of this share seems small, let us not forget two: first, there are other programmes for funding the research and development activity and second, there is an increasingly greater interest in a higher public-private collaboration, namely for the research and development activity to get results which shall be taken over by the private sector and capitalized at industrial scale.

One exception to this regard is given by the funding of research on artificial blood, research made in the public system (in academia), but the results of this research could be capitalized in the private sector, and from these endeavors, the Romanian state, the one funding this research, could be the one to profit.

Synthesizing information from two tables results in Figure 1.

We must take note of the fact that until 2008 there was another source of funding for fundamental research, especially in academia, namely through grants. These represent a form of funding, based on competition, of the research themes containing elements of originality. Besides funding research activities, the purpose of a grant is to contribute to training and developing scientific careers, for funding research related activities (purchase of equipment for research, production of publications, organization of scientific meetings, patenting research results, mobility, fellowships, etc.).

Organized and funded through the National Council of Scientific Research in Higher Education (CNCSIS), the grants were conducted over 1-3 year periods for priority fields and on thematic areas in which the project proposal could fall within. In these regard, we must mention: multiannual grants for scientific research (type A), multiannual grants for young researchers (type AT), individual research programmes for young PhD candidates (type TD), scientific research scholarship programs for young PhD candidates (type BD) and type A multiannual grants for scientific research-consortium (whose objective was to create consortiums between research teams with the purpose of developing network focused on the development of highly complex research topics). [2]

#### 4. Conclusions

In this paper, I sought to present a source of funding for the research and development activity. As shown throughout the paper, at first glance, the values allocated in 2009-2013 seem small compared to the needs in the field, but even as small as they are, they represent an important source of funding for some of the national research institutes, who can substantiate their budget taking into account these amounts comprised in the Core Programme.

Beside the Core Programme, there are also other programmes for funding the research and development activity, such as structural funds, the Framework Programme

7 (FP7), The National Programme for Research, Development and Innovation II (PNCDI II) and last, but not least, Horizon 2020.

Furthermore, there is an increasingly higher emphasis on research agreements between public entities and the private sector. Personally, I would opt for the Romanian State to set up a venture fund which could be used for funding projects which could, in their turn, generate income which could be fed into this venture fund, to fund other projects, generating other income, etc.

Scientific research is not definitively concluded once the final results are obtained. These results represent, for the moment, only the fulfillment of the objectives sought in the beginning by that research. Beyond these objectives, other aspects, many of them new, can be followed, more or less distinctly, aspects which could become possible and/or necessary future research themes. Thus way, the results of the research can be used either in a practical sense, immediately applicable, or in a theoretical sense. In the latter version, they will be the premises for future researches.[3]

#### 5. References

- [1] Almus, M., Czarnitzki, D., (2003), *The Effects of Public R & D Subsidies on Firms' Innovation Activities*, Journal of Business and Economic Statistics, vol. 21(2), pp. 226-236
  - [2] Şimandan, M., (2010), *Metodologia cercetării științifice*, Mirton Publishing House, Timișoara
  - [3] Gheorghe, I. G., (2008), *Metodologia Cercetării Științifice, Dezvoltării și Inovării*, CEFIN Publishing House, Bucharest
- Romanian Statistical Yearbook 2009  
Romanian Statistical Yearbook 2010  
Romanian Statistical Yearbook 2011  
Romanian Statistical Yearbook 2012  
Romanian Statistical Yearbook 2013  
[www.ancs.ro](http://www.ancs.ro)



Table 1. The value of funding through the Core Programme in 2009-2013

Period	2009	2010	2011	2012	2013
Value of funding	228.037	246.092	257.285	266.197	259.818

Source: Author's data processing from [www.ancs.ro](http://www.ancs.ro)

Table 2. The value of funding for research and development activities in 2009-2013

Period	2009	2010	2011	2012	2013
Value of funding (thousands lei)	2.356.900	2.413.500	2.786.800	2.872.700	2.464.800
Share in GDP (%)	0,48	0,47	0,48	0,47	0,39

Source: Author's data processing from the Romanian Statistical Yearbook 2009-2013

Figure 1. The value of funding for the research and development activity through the Core Programme and from the Budget in 2009-2013

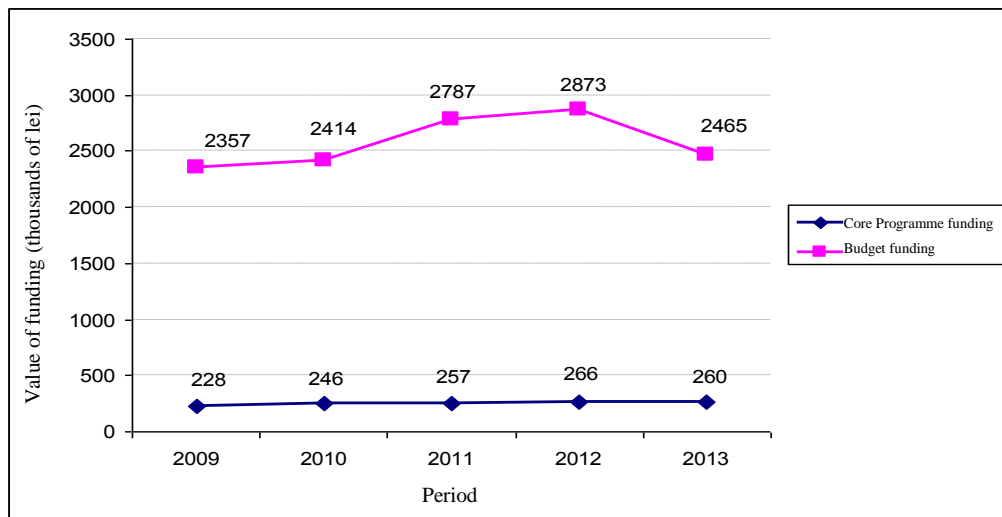

Source: Author's data processing from the Romanian Statistical Yearbook 2009-2013

## Ethics and Morality in the Accounting Profession

Diana Andreea Trăistaru

University of Craiova, Faculty of Economics and Business Administration  
[traistaru.diana@yahoo.com](mailto:traistaru.diana@yahoo.com)

### Abstract

*The accounting sphere is influenced by local institutions despite the efforts made for the internationalization and alignment to international practices.*

*International organizations such as IFAC, ACCA or ICAEW offer support and orientation on the basis of a global model of profession which, in many cases is influenced by the evolution of developed countries. On the other hand, in less developed economies, the profession appears under the influence of local and global tensions.*

*Factors like globalization, the process of accounting convergence and the convergence of the activities of professional organizations or technology development may generate uniformity for the profession and a balanced role or image of the accountant.*

**Keywords:** Accounting education, Accounting profession, Accounting convergence, Expectation profession, Ethics codes.

**JEL Classification:** M41.

### 1. Introduction

The accounting profession competes with other professions and that is why it is essential for us to study the image perceived in society, the challenges it faces, but also future tendencies and predictions.

The profession's image is very important, having influences on social position, the profession's attractiveness and the role that its members have in society. It is important to analyze the image of the accounting in our days, in order to get a point of view in determining the market and development strategies in this field.

In present, the accounting profession is regulated by Directive 2013/55/UE of The European Parliament and The Council,

referring to the acknowledgement of professional qualification of changing the Directive 2005/36/CEE, being recognized at a European level.

The accounting profession aims not only at the needs of clients, employees, banks, investors, but also to the public needs and features independence in decision making by auditors, as they are the ones reestablishing economic balance and supporting the public trust in the decisions regarding the overtaking of economic crisis.

Specialists in the area may attain the public's expectations referring to the uprightness of financial statements by manifesting a transparent and fair professional behaviour in auditing, in conformity with international standards and ethical regulations.

The accounting professional is the specialist that has prepared and formed himself according to the standards imposed by the state in which he is going to activate.

He has to maintain a certain degree of conformity of the financial-accounting activities with the regulations in the area, ensuring in this way the possibility of the company's sustainable development and not only of the profession.

### 2. The accounting professional and ethics

The present study aims at certain aspects referring to the ethics and morality in the accounting profession, the objective of the study being the attempt to prove that an unethical behaviour is present only in the case of some errors in financial reporting, but also in the case in which accounting professionals use information for the purpose of dilapidation.

Bunea et al. (2013) [2] approach the subject of ethical behaviour in the accounting profession and states that "ethics requires to the accounting professional honesty and

integrity in the exertion of its own mission, thing that seems to be important enough".

That is why, basing on professional competencies and the independence of the accounting professional, the entity should enjoy special moral values, and professional should offer the company not only professional services but also personal involvement on the basis of high moral principles.

De Villiers et al. (2014) [3] think that "the activity of accountants and auditors implies a high degree of ethics. Users of financial statements base on the annual financial reports of a company because the data provided are useful in the process of decision making for future investments".

The accounting professional must recognize ethics and the ways of overcoming obstacles, so that he may take the most efficient decisions even if the public would be the beneficiary of these choices and not the company.

The accounting professional has the duty to follow the most strict requirements of ethics and morality concerning the information provided. Not following these ethical criteria may lead to errors, influencing unproductive investments, or mistaken presentations of the companies' financial statements.

In various national empirical studies, the subject of accounting profession represented a major issue, having as proof the articles that have appeared lately.

Ristea and Dumitru (2012) [6] approach "The Accountants' Code of Ethics from the point of view of the professionals' confidentiality, behaviour and competencies in the area".

Based on articles that we have studied, companies and individuals counseled by accounting professionals are indebted to know their own ethical responsibilities.

The companies' managers have an increasing responsibility in proving the conformity of the approached ways and strategies with the public interest and the criteria set by the shareholders.

There are numerous professional associations that regulate the accounting profession, by means of different application strategies of certain ethical organizations.

In Figure 1. are presented a series of important roles for the codes of ethics, as follow:

Figure 1. Important factors of the codes of ethics

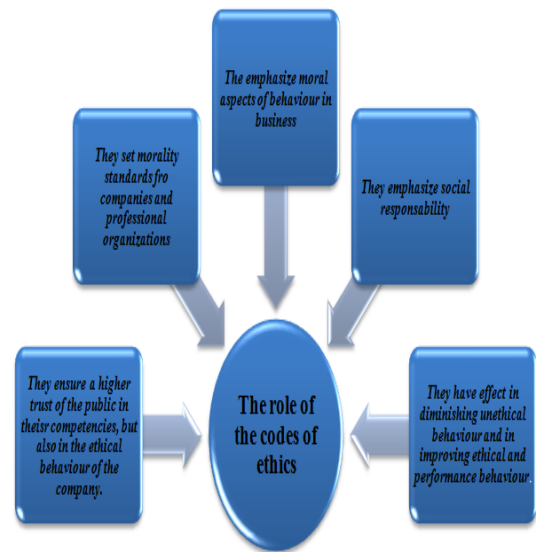

Source: Toma, M. [9]

CECCAR is the organization that sets the professional behaviour criteria for accounting professionals, regulations that could be structured according to The National Code of Ethics for Accounting Professionals (2006) in Figure 2. as it is presented below:

Figure 2. CECCAR Principles

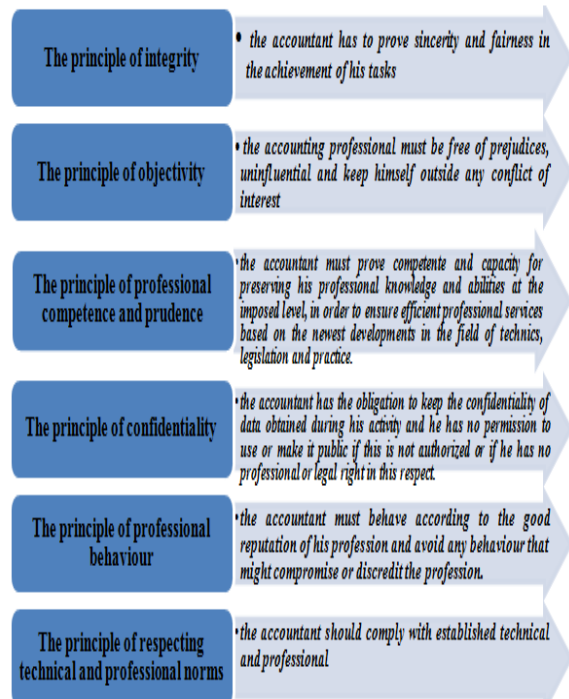

Source: Toma, M. [9]

The accounting professional has a certain responsibility regarding the users of accounting services, clients, investors, employees, employers, so that there could exist an efficient economic functioning.

The activity of accountants and their behaviour are important factors in the economic development of the country in which they activate.

### 3. The role of morality in the accounting profession

The accounting profession has a very significant role in issuing and analyzing accounting data, indispensable for users in making decisions.

Tingey-Holyoak and Burritt (2012) [8] approach "moral development as a succession of six phases", model used in various studies of accounting ethics which have revealed the fact that accounting professionals and students gave obtained low results comparing to students and graduates pertaining to other study fields.

Usually, there are some contradictions concerning the role of morality in the field of administration, business and law.

Solomon et al. (2013) [7] present "the role of morality as a natural permission of the accounting profession to harm others, in the case in which this role wouldn't be affected".

Morality represents a decisive factor in maintaining a high standard of prestige and integrity of the accounting profession.

### 4. Ethical regulations in the accounting profession: an international, European and American approach

National literature focused a lot on ethical aspects of the accounting profession, taking into account international ethical norms, being provided both by CECCAR and CAFR. Table 1. presents a highlight of ethical criteria of accounting professionals through reflecting them in international norms, secondly, European legislation in the field is presented and not at least, there are approached American norms that have to do with this analyze.

As a result of numerous accounting norms imposed to accounting professionals, in Table 1, we have tried to highlight both the

usefulness and the compulsion of ethical criteria linked to the approached subject.

Table 1. Ethical criteria of accounting

The regulatory authority
<p><b>At international level</b></p> <p>IFAC comprises 164 members and associations from 125 countries and jurisdictions</p> <p>Role:</p> <ul style="list-style-type: none"> <li>➢ encouraging the respecting of certain international norms of quality</li> <li>➢ promoting cooperation with the professional organization it comprises</li> <li>➢ Support the accounting profession at an international level.</li> </ul> <p>The IFAC issued norms comprise:</p> <ul style="list-style-type: none"> <li>➢ International Auditing Standards, Insurance Missions and Additional Services</li> <li>➢ International Standards of Quality Control</li> <li>➢ International Code of Ethics for Accounting Professionals</li> <li>➢ International Standards of Education</li> <li>➢ International Accounting Standards for the Public Sector</li> </ul>
<p><b>At UE level</b></p> <p>UE has a series of norms:</p> <ul style="list-style-type: none"> <li>➢ Regulations must be applied by all UE member states, a national transposition being unnecessary</li> <li>➢ Directives are mandatory for attaining the economic, social and judicial objective, their transposition depending on the decision of the member states</li> <li>➢ Decisions are mandatory applicable, the parts involved can be individuals, companies or member states</li> </ul>
<p><b>At the USA level</b></p> <p>In USA there was an attempt of self-regulation of professionals and a corporative governance of entities so that the effects of scandals in the accounting sphere could be annihilated.</p>
Fundamental principles
<p><b>At international level</b></p> <p>Every accountant has the duty to follow a series of main rules:</p> <p>The principle of integrity: fairness in the relations maintained</p> <p>The principle of objectivity: avoiding favouring, prejudices and the conflicts of interest that might harm the business practice</p> <p>The principle of professional competence: requires the accountant to preserve the same capacities and knowledge in his area</p> <p>The principle of confidentiality: not to make public data obtained and not using it for personal or other purposes</p> <p>The principle of professional behaviour: the conformity of the accounting professional's activity with the stated regulations and avoiding to damage the profession.</p>
<p><b>At UE level</b></p> <p>At UE level the following principles are being respected:</p> <p>The principle of objectivity: can be controlled from the inside</p> <p>The principle of integrity: can be previously checked</p> <p>The principle of independence: depends on the auditor's liability and the way in which he respects it</p> <p>The principle of professional competence and proper attention: it completes the three principles mentioned above through Directive 2006/43/CEE of the European Parliament and The Council, 17<sup>th</sup> of May 2006, referring to the statutory audit of annual and consolidated accounts.</p>
<p><b>At the USA level</b></p> <p>The principles provided by The Code of Professional Behaviour:</p> <p>The principle of integrity: the absence of any relation between beneficiaries, earnings and the activity conducted</p> <p>The principle of objectivity and independence: the activity must be free of any conflict of interest</p> <p>The principle of proper attention: professional training for services</p>
Professional competence
<p><b>At international level</b></p> <p>IASB aims at the public interest through:</p> <ul style="list-style-type: none"> <li>➢ The setting of certain quality criteria and publishing materials in which there are provided examples of good practices</li> <li>➢ The support for applying International Standards of Education</li> <li>➢ The setting of a benchmarking system in education with a role in appreciating the adoption of International Standards of Education</li> </ul>
<p><b>At UE level</b></p> <ul style="list-style-type: none"> <li>➢ A 3-year preparation is necessary, from which 2 years should be a stage of practice with a statutory auditor from a member state.</li> <li>➢ A third option would be that for individuals requiring for authorization to have at least 7 years of experience, the stage of practice accomplished and the professional exam passed</li> </ul>
<p><b>At USA level</b></p> <ul style="list-style-type: none"> <li>➢ An individual has to pass different exams provided by AICPA in order to become an auditing professional</li> <li>➢ There are also practice and professional training courses</li> <li>➢ This field has become more and more attractive in the USA, as a result to changes brought to the different forms of examination.</li> </ul>

Source: Ristea, M., Dumitru, C.G. [6]

International ethical criteria have an important place in the context of the present internationalization of accounting profession.

Toma (2011) [9] talks about "the exactness and ethical criteria of auditors in their activity".

Mutiu and Tiron (2012) [5] present "the relation between ethics and professionalism", and Ristea and Dumitru (2012) [6] present in a structured way "the ethical problems linked to auditing and the accounting profession".

DeVilliers et al. (2014) [3] approach "a subject referring the reputation of accounting professionals, as one of their main qualities".

IFAC is the organization that was most concerned with the obeying of accounting ethical standards.

The principles provided by the IFAC Code of Ethics are the accounting professionals' integrity, expertise and transparency.

Bunea et al. (2013) [2] hold that "ethical principles represent the most exact form by which professions admit the responsibilities they have towards society".

## 5. Conclusions

Society gives the accounting profession an important role, the professionals' behaviour in providing financial information having a decisive influence on the economic state of the companies in which they activate.

The accountant not only reports, but also influences the management's decisions, and this denotes that the way in which the professional works is extremely relevant.

In the late years, there has been a growth of the interest given to accounting ethics. However, there are a series of disadvantages concerning some principles and norms.

Ethics bears a special significance for accounting professionals and for those who use their services, the beneficiaries considering that financial statements are objective and transparent.

The accountant of our days has the duty to improve in the same rhythm as legislation, the business context and the management strategies. Given the fact that the public trusts a lot the accounting professionals' decisions, the maintaining of an efficient degree of objectivity becomes indispensable in the accounting sphere.

Professionals must overcome the rules they have been accustomed to from the beginning of their careers, and they need new and modern methods and techniques in order to accomplish with their responsibilities in front of the public.

## 6. References

- [1] Bebbington, J., Unerman, J., O'Dwyer, B., *Sustainability accounting and accountability*. 2nd edition. London: Routledge, 2014, pag. 48-50;
- [2] Bunea, S., Săcărin, M. & Gîrbină, M.M., *An analysis of the perception of chartered accountant trainees regarding access to the accounting profession and professional training needs*, *Analele Universității din Oradea*, July, 2013, pag. 1157-1160;
- [3] De Villiers, C., Rinaldi, L., Unerman, J., *Integrated Reporting: Insights, gaps and an agenda for future research*, *Accounting, Auditing & Accountability Journal* 27(7), 2014, pag. 1053-1055;
- [4] Heffes, E., *Global accounting firm CEOs on challenges - transitioning from GAAP to IFRS, and more*. In D. L. Street & B. E. Needles Jr. (Eds.), *IFRS Digest: What U.S. Practitioners and Entities Need to Know Now* (pp. 185-188). New York, NY: American Institute of Certified Public Accountants, Inc, pag. 49-52, 2008;
- [5] Mutiu, A.,I., and Tiron Tudor, A., *Are Romanian universities preparing leaders in accounting?*, *Annals of Faculty of Economics*, vol. 3, no. 1, 2009, pag. 1075-1080;
- [6] Ristea, M., Dumitru, C.G., *Libertate și conformitate în standardele și reglementările contabile*, Editura CECCAR, București, 2012, pag. 58-63;
- [7] Solomon, J. F., Solomon, A., Joseph, N. L., & Norton, S. D., *Impression management, myth creation and fabrication in private social and environmental reporting: Insights from Erving Goffman*, *Accounting, organizations and society*, 38(3), 2013, pag. 209-212;
- [8] Tingey-Holyoak, J., & Burritt, R., *The transdisciplinary nature of accounting: A pathway towards the sustainable future of the profession*, *Emerging Pathways for the Next Generation of Accountants*, vol. 3, 2012, pag. 95-98;
- [9] Toma M., *Drumuri prin memoria profesiei contabile*, Ed. CECCAR, București, 2011, pag. 35-40.

# The Influence of the Private Sector Financing on the Decision to Invest in Romania

Adina Trandafir  
Spiru Haret University  
[trandafir.adina@yahoo.co.uk](mailto:trandafir.adina@yahoo.co.uk)

## Abstract

*The business environment in the economy manifests itself in a variety of forms and with very different results that are not reflected only in the economic and financial welfare.*

*The business environment and related activities are influenced by a number of decisive issues. The issues that have a major influence on business activity can be grouped in five categories: government policies and programs; socio-economic conditions; the education system and entrepreneurial culture; financial support (financial assistance); the transfer of R & D results.*

*In an attempt to show the negative effects of government policies adopted in Romania by under-financing private sector, this article examines the impact of the size of funds allocated to private sector on the decision to invest in our country. Using regression technique in empirical analysis in this article it is shown that the investment decision is influenced to a large extent by allocated funds.*

**Key words:** Financing, Investment Decision, Business Environment, FDI

**J.E.L. classification:** G38

## 1. Introduction

In Romania, financial support / financial assistance has a major impact on the business environment. According to a survey conducted by Ernst & Young, 82% of respondents, Romanian businessmen, consider that the access to founding sources is difficult and very difficult [2].

Financial assistance relates to the extent to which business start-ups manage to obtain financial resources. This dimension includes also financial support quality and

accessibility of financial resources, diversity of funding sources, the cost of borrowing, interest of credit institutions to support entrepreneurial firms, facilities for businesses. Equity of companies generally comes from own funds or from borrowed financial resources [3].

Generally, a business needs financial support for at least one of the following reasons: to share the financial risk of investing in a business, to have monetary capital needed to start a business or to expand its business [3]. However, financial support does not always stimulate the opening of new businesses, so that, in some cases, to determine the establishment of a new business is needed, also, of non-financial support [4].

## 2. Evolution of Romanian private business sector financing

According to the study conducted by Ernst & Young, in 2014[1], the sources of funding used and their destinations given by business environment, in 2014, had the following development and share:

- financing for investment registered a spectacular increase, 60% of the funding were for investments, 20% more than the previous year
- the access to finance for 2014 was viewed with pessimism by entrepreneurs who participated in the survey conducted by Ernst & Young, considering that the negative evolution of the Romanian economy since 2014 has not given them great opportunities to access different forms of financing
- bank credit remains the most important source of finance but in 2014 recorded a decrease of 10% from the previous year, falling below 50% of preferences.
- The second source of funding considered

by entrepreneurs is represented by European funds, which share has almost doubled in preferences from the previous year, reaching 26%.

- State aid represented in a very small extent (1%) an option for financing the business environment project, even if the Romanian state has attempted to implement various aid schemes.
- Regarding the relation entrepreneur - financier, most companies have not changed financier in the last two years, which indicates either lack of options or the fact that they are satisfied with the terms of the financing obtained [4].
- Regarding the sectors that have easily obtained financing business the businessmen who participated in the study, believe that the IT sector still is on top, even if registered a sharply decreasing compared with answers from the previous year, from 39 % in 2013 to 25% in 2014. Other sectors considered - agriculture, green energy and production are all perceived growth in terms of attractiveness for donors [1].

The decisive factor in choosing contractors for supply of funding represented as the previous year, preserving the independence in business decisions (36% of respondents), followed by the lowest costs (23%) and quality of guarantees (17%) [1].

One of the factors with major impact on the decision to invest in the private sector is the funding sources and access to them.

Romania faces a major problem: insufficient funding in an attempt to revive the national economy.

At the end of January 2015 the domestic credit for the private sector fell to a share of damage, less than 30% of GDP estimated for 2015[2].

The financing of private sector reached a maximum of 40% in 2011 relative to GDP. Thereafter, domestic credit began to decline significantly both to the needs imposed by economic growth target, but even in nominal terms if the reporting at the 2012, only in which the level recorded has exceeded 300 billion[1].

*Table 1. The financing of private sector from domestic credit in 2008-2015*

Year	Domestic Credit		For private sector		
	Billion RON	% GDP	Billion RON	% total domestic credit	% GDP
2008	215,3	41,8	198,1	92,0	38,5
2009	246,7	49,2	199,9	81,0	39,9
2010	270,7	51,7	209,3	77,4	40,0
2011	293,9	52,7	223,0	75,9	40,0
2012	304,7	51,1	225,8	74,1	37,9
2013	298,9	46,9	218,5	73,1	34,2
2014	296,5	44,3	210,9	71,2	31,5
2015 (january)	297,2	42,1	210,3	70,8	29,8

Source: own processing of data available on [www.bnr.ro](http://www.bnr.ro)

Production processes require money to be developed and the funding deficit affects the functioning of the economy.

To move to the real picture, through which to maintain correct proportions from year to year, they should be adjusted by the annual average inflation rate for the period under review.

If this is done, we can see that the nominal value of domestic credit between 2009 - 2014 increased by 20.2% compared with 21.9% accumulated inflation, which actually lead to a decrease of 1,4% in real terms last year compared to private sector financing situation at the start of the economic crisis.

The money were directed more less to the private sector which generate economic growth and more and more to state, where they had to cover the increased need for funding after some obligation undertaken in a questionable way in relation to real possibilities and with the stated purpose of reducing the rapid development gap towards the West.

Thus, from the 92% share of total domestic credit to the private sector in 2008, the year of maximum economic growth since 1989 (according to the latest provisional data, in 2014 was 99.7% of that amount), was gradually lowered to a level of 70%. And this amid lower total domestic lending itself relative to GDP growth [1].

Against the background of economic difficulties crediting has been redistributed to the Government, which committed massive expenditure not with banking system support (as happened in other countries) but with social protection-election. Thus, in four

years, 2008 - 2012, governmental credit share in GDP has quadrupled, together with local banks exposure to the performance in managing public funds [1].

Table 2. The financing of private sector from governmental credit 2008-2015

Year	Domestic Credit		Governmental credit granted		
	Billion RON	% GDP	Billion RON	% in total domestic credit	% GDP
2008	215,3	41,8	17,2	8,0	3,3
2009	246,7	49,2	46,8	19,0	9,3
2010	270,7	51,7	61,4	22,7	11,7
2011	293,9	52,7	70,9	24,1	12,7
2012	304,7	51,1	78,9	25,9	13,2
2013	298,9	46,9	80,5	26,9	12,6
2014	296,5	44,3	85,5	28,8	12,7
2015 (january)	297,2	42,1	86,8	29,2	12,3

Source: own processing of data available on [www.bnr.ro](http://www.bnr.ro)

Basically, rather than risk crediting of some businesses which quickly revive the economy after the recession of 2009 (mini extended in 2010) and against the backdrop of pronounced deleveraging (in which the credit lines of the order of 6-7% of GDP left Romania) banks chose to allocate the resources available on a minimal effort of lending a good payer with minimum risk analysis.

Of course, it can invoke the need to improve the prudent financial stability indicators, but exactly risk aversion explains why the financial return rate remained into negative territory except the successful attempts at limit (and not republished) return on profit in 2013 (and this to the whole system).

The decrease since 2012 in the share of government credit to GDP, show that money is not even clearly still go towards supporting the Government's economic policies.

Moreover, the state has not undertaken any significant investment in recent years, more appeal to this segment funding cuts to balance public finances.

The paper must comply with the structure agreed by the journal and is mandatory to contain: introduction, content (with chapters and subchapters designed/established by author(s)), conclusions and references.

### 3. Analysis of decision to invest in Romania based on access to funding sources

Regarding the decision to invest, the problem can be analyzed in terms of private sector funding (captured by the absolute size of domestic credit to finance domestic sector).

To analyze the impact of the funding on investment decision (captured by the FDI in Romania, will use regression technique.

The variables used in the analysis are:

- the existing FDI stock at the end of each period analyzed, rated "investment decision";
- the absolute size of domestic credit to finance private sector.

Data refer to a period of eight years respectively at the period 2008-2015 (January), and descriptive statistics of the variables is as follows:

Table 3. The descriptive statistic of the variables

	INVESTMENT_DECISION	FINANCING
Mean	6.312400	2005.2000
Median	7.250000	211987.7
Maximum	9.496000	225836.2
Minimum	2.269000	198055,7
Std. Dev.	3.274314	9.549869
Skewness	-0.277292	1.370373
Kurtosis	1.335816	3.105725
Jarque-Bera	0.641057	1.567264
Probability	0.725765	0.456744
Sum	31.56200	1695901.00
Sum Sq. Dev.	42.88453	364.8000

Source: own processing of data available on [www.bnr.ro](http://www.bnr.ro) and [www.insse.ro](http://www.insse.ro)

Using the method of least squares, we determine the value of variables of the linear regression equation, as follows:

*The investment decision and funding*

Following the procedure as parameter estimation regression model were obtained the following results

Table 4. The results estimation of parameters of the regression model between investment decision and financing

Dependent Variable: INVESTMENT_DECISION				
Method: Least Squares				
Sample: 2008 2015				
Variable	Coefficient	Std. Error	t-Statistic	Prob.



FINANCING	0.251794	0.1348	-1.87453	0.1576
C	57.98050	27.5941	2.101191	0.1264
R-squared	0.539317	Mean dependent var		6.312400
Adjusted R-squared	0.385757	S.D. dependent var		3.274314
S.E. of regression	2.566201	Akaike info criterion		5.011904
Sum squared resid	19.75616	Schwarz criterion		4.855680
Log likelihood	-10.52976	F-statistic		3.512075
Durbin-Watson stat	2.852379	Prob(F-statistic)		0.157620

Source: own processing of data available on [www.bnr.ro](http://www.bnr.ro) and [www.insse.ro](http://www.insse.ro)

Based on these results, the regression equation is:

$$Invest\_decision = 57.98 + 0.252 * Financing$$

According to this equation can make the following comments:

- between FDI and financing there is a positive linear dependence, i.e. the relationship between the two variables is directly proportional: a modification by 1 mil RON credit to private sector financing, the FDI will change in the same direction with € 0.252 billion;
- between the value of F statistics and t, which corresponds of the regression slope, check relationship  $t^2 = F$ .

The coefficient of determination for the regression signify that 53.9% of the investment decision variation is explained by the funding variation.

The correlation matrix between the variables considered are:

Table 5. Correlation Matrix

	INVESTMENT_DECISION	FINANCING
INVESTMENT_DECISION	1.000000	-0.734382
FINANCING	-0.734382	1.000000

Source: own processing of data available on [www.bnr.ro](http://www.bnr.ro) and [www.insse.ro](http://www.insse.ro)

Data analysis presented in the previous model, determine the following conclusions:

- correlation coefficient, of the regression equation shown above, by 53.9% demonstrates that the statistical relationship

between the result variable (the investment decision) and endogenous is strong, which demonstrates that the level of private sector funding in Romania significantly influence the decision of foreign investors to locate on the Romanian market.

#### 4. Conclusions

In conclusion of this scientific approach is appropriate to expose the main conclusions and results drawn during the development of the topic, defining the limits and highlighting this research and future research prospects in this complex area.

The scientific approach started from outlining a conceptual framework for the research area set.

Regarding the decision to invest, the problem can be analyzed in terms of private sector funding (captured by the absolute size of domestic credit to finance domestic sector).

To analyze the impact of the funding on investment decision (captured by the FDI) in Romania was used regression technique.

The variables used in the analysis were the existing FDI stock at the end of each period analyzed, rated "investment decision"; the absolute size of domestic credit to finance private sector. The results of the econometric analysis shows that between FDI and financing there is a linear positive and the relationship between the two variables is directly proportional: a modification by 1 mil RON credit to private sector funding, the FDI will change in the same direction to 0.252 billion €. Also, the correlation coefficient, the regression equation shown above, 53.9% demonstrates that the statistical relationship between the variable result (the investment decision) and endogenous is strong, which shows that the private sector funding Romania influences significant foreign investors' decision to locate the Romanian market.

The recommendation for future research refers to empirical analysis undertaken so as to achieve results more complete impact analysis of factors collateral on private business owners in Romania is necessary to expand the research, taking into account the transfer of results of research and development on it or the way in which issues such as investment / spending on R & D

affects the economic activity of private entities in Romania.

## 5. References

- [1] EY, (2014), *Bank loans take a downward trend, while European funds increase in entrepreneurs' funding options*, [on-line], Available at: [http://www.ey.com/RO/en/Home/Press-release\\_Romanian-entrepreneurs-access-to-funding\\_25-Sept-2014](http://www.ey.com/RO/en/Home/Press-release_Romanian-entrepreneurs-access-to-funding_25-Sept-2014), [Accessed on: 20.10.2015]
- [2] E.Y. (2015). *Antreprenorii vorbesc – Barometrul antreprenoriatului românesc, Ediția a IIIa*, [on-line], Available at: [www.eyromania.ro/sites/default/files/attachments/ESO%202015.pdf](http://www.eyromania.ro/sites/default/files/attachments/ESO%202015.pdf), [Accessed on: 20.10.2015]
- [3] Fundația Post-privatizare, (2012). *Promovarea antreprenoriatului ca factor cheie pentru dezvoltarea economică*, [on-line], Available at: [www.postprivatizare.ro](http://www.postprivatizare.ro), [Accessed on: 25.10.2015]
- [4] OECD, (2011). *Entrepreneurship at a Glance 2011*, [on-line], Available at: [http://www.oecd-ilibrary.org/industry-and-services/entrepreneurship-at-a-glance-2010\\_9789264097711-en](http://www.oecd-ilibrary.org/industry-and-services/entrepreneurship-at-a-glance-2010_9789264097711-en), [Accesat la data: 21.06.2015].
- [5] [www.bnr.ro](http://www.bnr.ro)
- [6] [www.insse.ro](http://www.insse.ro)

## External Financing for EU SMEs – Challenges, Measures and Trends

Laura Vasilescu

University of Craiova

[laura\\_giurca\\_vasilescu@yahoo.com](mailto:laura_giurca_vasilescu@yahoo.com)

Sorin Tudor

University of Craiova

[tudorsorin2007@yahoo.com](mailto:tudorsorin2007@yahoo.com)

### Abstract

*Increasing the capacity of SMEs to access finance is important for funding business investment, ensuring businesses growth potential, and for facilitating new business start-ups.*

*The most important sources of finance for EU Small and Medium Enterprises (SMEs) are the external sources: bank overdrafts, bank loans, leasing, trade credit and other loans. The access to external sources for is influenced by various factors, structural, cyclical, from supply and demand side.*

*The main obstacles for accessing financing sources, the recent evolutions and trends regarding the SMEs financing but also the main actions and policies taken at the European level are analyzed in this paper.*

**Key words:** financing, challenges, influence factors, SMEs, EU

**J.E.L. classification:** G32, M21

### 1. Introduction

The success on economic field in Europe depends on achieving the full development potential of Small and Medium Enterprises (SMEs).

Compared with the large companies that have direct access to capital markets, the Small and Medium Enterprises face many challenges when accessing finance for development and innovation [Berger and Udell, 2005], [Ayyagari et al, 2006], [Beck, 2007].

The access to finance is an important incentive for SMEs' development, increasing growth potential, investment and innovation.

Among the financing sources the external ones represent the main source for financing the SMEs.

External finance is an important part of the market mechanism by facilitating the allocating of resources within the economy.

Therefore, the external finance support new businesses with innovative or more efficient products and services. This determines improvements in productivity and an increased efficiency in using the financial resources in economy.

Various factors affect the external financing to SMEs in the European Union from both supply and demand side. Some obstacles have a cyclical nature, others are structural and the information asymmetry between the suppliers of funds and SMEs play a major role.

The European Commission introduced different measures, policies and action plans in order to facilitate the access to finance for SMEs, to establish a healthy financial system for economic growth (Small Business Act, Single Market Act, Europe 2020 - Europe growth strategy).

### 2. Accessing external finance by EU SMEs

The statistics indicate that one of the main challenges the SMEs have to face is the access to finance (10%) after finding customers (25%), skilled staff (18%), competition (14%), regulation (13%) (figure 1).

There are differences between EU countries regarding the access to finance. Thus, the access to finance is the most important problem for SMEs in Greece (34%), Ireland and the Netherlands (15%), compared with only around 7% of SMEs in Germany and Austria which perceive this

problem less important than before [EC, 2015a].

Figure 1. Main problems faced by UE SMEs

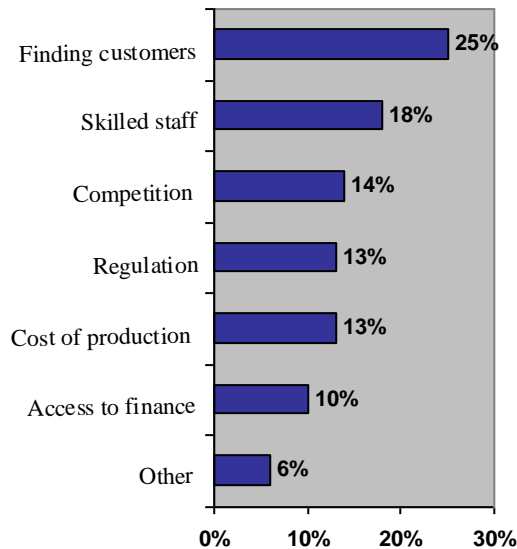

Source: EC Survey on the access to finance of enterprises (SAFE) Analytical Report 2015, Dec. 2015

The most important sources of finance for EU SMEs are the external sources: bank overdrafts (55%), bank loans (54%), leasing (44%), trade credit (34%), other loans (23%). (figure 2).

Figure 2. Financing sources for EU SMEs

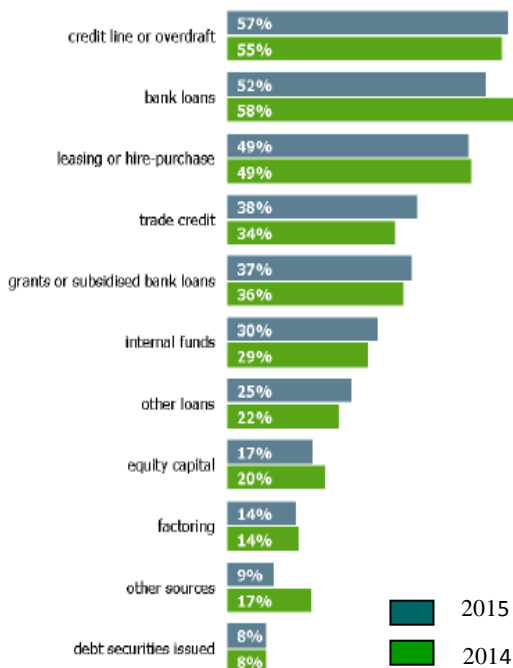

Source: EC Survey on the access to finance of enterprises (SAFE) Analytical Report 2015, Dec. 2015

On the other side, the internal financing play an important role as an alternative source of finance for 30% of Small and Medium Enterprises.

Regarding the categories of SMEs, the small firms use mostly credit lines and bank overdrafts, followed by bank loans on long-term, trade credit and leasing. The medium and large firms report credit lines as most important financing instrument followed by leasing, bank loans and trade credit as other external financing sources. [EC, 2015b].

Considering the EU countries, the highest increased demand for bank loans was registered by Greece (28%). By contrast, SMEs in Austria and the Netherlands registered a decrease of need for bank loans.

Regarding the availability of external finance, in 2015 the external financing conditions improved compared to the previous year: bank loans (from 14% to 23%) and bank overdrafts (from 11% to 17%). [EC, 2015b].

Among the EU countries, there were registered an improvement in the availability of bank loans for SMEs in Germany and Spain (from 11% in 2014 to 30% in 2015). In France and Italy, SMEs reported a negative net percentage.

The financial crisis increased the financing gap for SME financing which measures the difference between the need for external funds and the availability of funds for firms. Banks tightened lending standards during the financial crisis.

The external financing gap for EU SMEs, has been reduced to zero in 2015 (from 3% in 2014). In Greece there was registered an increase of the financing gap for SMEs (from 24% to 28%) [EC, 2015b].

### 3. Influence factors on external financing for SMEs

The most important factors that affect the availability of external financing for SMEs, are the followings [EC, 2015b] (figure 3):

- general economic outlook,
- access to public financial support,
- firm-specific outlook,
- the willingness of banks to lend,

- credit history,
- firm's own capital.

Figure 3. Influence factors on external financing for EU SMEs

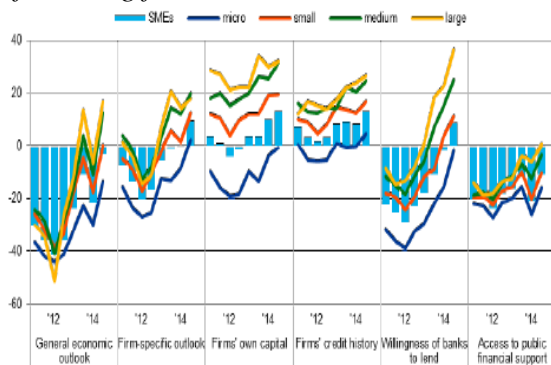

Source: EC Survey on the access to finance of enterprises in the euro area October 2014 to March 2015, June 2015

In 2015, positive evolutions were registered in comparison with the previous year in the contributions of factors related to credit history (13%), firms' capital (13%), firm-specific outlook (10%) and the willingness of banks to lend (9%).

From the supply side, there was registered an improvement in banks' willingness to lend in 2015 compared to previous year (from -2% to 9%). The access to public financial support registered a less negative contribution (-11% from -21%).

Despite the improvement of the availability of bank loans for companies, the EU SMEs reported a fall in interest rates (from -9% to -25%) and an increase in the available size (from 3% to 8%) and maturity (from -1% to 2%) of loans and overdrafts (figure 4).

Figure 4. Conditions for bank loans granted to EU SMEs

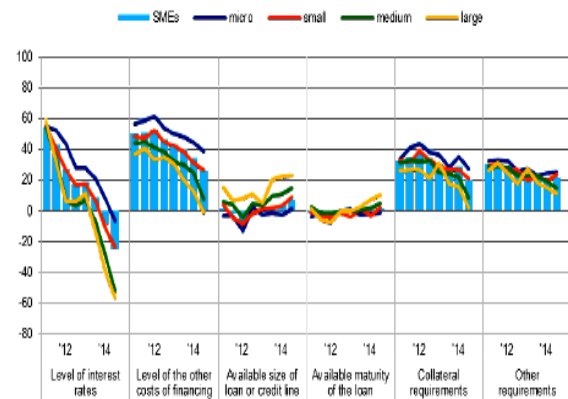

Source: EC Survey on the access to finance of enterprises in the euro area October 2014 to March 2015, June 2015

The significantly negative net percentages regarding the level of interest rates confirm the recent trends in the UE bank lending, reflecting a net easing of standards' credit.

The level of interest rate reflects the reduction in aggregate bank lending rates that occurred in 2015 compared to previous year. However, the statistics continued to indicate an increase of the bank collateral requirements.

The most common types of collateral for euro area SMEs were land or buildings (46%) and owner personal assets (45%). [EC, 2015b].

Collateral requirements were still high in 2015 but decreased for SMEs from Greece (46%), Austria (39%) and Finland (31%) compared with previous year [EC, 2015b].

#### 4. EU measures to address the financing challenges

The member States have taken various measures to facilitate the SMEs' access to finance in the last years. Many actions were taken in the countries affected by the crisis and where the bank lending conditions were tightened. In these countries there was enhanced the loan guarantee systems, mainly by increasing the allocation of public funds into guarantee schemes.

Other policy measures at national level regard the followings [EC, 2015c]:

- development of corporate bond and alternative markets for SMEs;
- facilitating the securitization of SME loans;
- easing the access and transfer of financial information;

- developing a regulatory framework for crowd funding;
- enhancing the public venture capital sector.

At European level, the measures regard the followings [EC, 2015c]:

- the finance supply for SMEs should be increased by the funds from the capital markets;
- building a pan-European approach to better connect SMEs with a wide range of funding sources;
- facilitating securitization;
- creating the appropriate regulatory frameworks for innovative sources of funding;
- measures to support venture capital and risk capital financing in the EU,
- support private investments using EU resources through a pan-European funds-of-funds;
- the promotion of best practice on tax incentives;
- creation of the new European Fund for Strategic Investments (EFSI);
- improvement by SMEs of the quality, availability, comparability of the relevant information for potential investors.

Also, the programme for the Competitiveness of Enterprises and Small and Medium-sized Enterprises (COSME) with a total allocation of €2.5 billion Euro for the period 2014-2020 is aimed to improve the access to finance for SMEs through two financial instruments [EC, 2014]:

- Loan Guarantee Facility (LGF) aimed to fund guarantees for financial intermediaries (banks, organizations, leasing companies) in order to provide more loans to SMEs;
- Equity Facility for Growth (EFG) is dedicated to investments in risk-capital funds that provide venture capital and mezzanine finance to expansion and growth-stage SMEs.

COSME financial instruments are used in conjunction with those of the Horizon 2020 Framework Programme for Research and Innovation (InnovFin – EU Finance for Innovators).

## 5. Conclusions

Access to finance is one of the key factors for business development, investment and innovation of SMEs. At present, difficulty in accessing finance is still one of the main barriers to the growth for many SMEs.

Considering the financing sources, the majority of SMEs use primarily the external sources, being reliant on debt financing by banks.

Among the external sources, the credit line, overdraft and bank loans are the most important sources of financing for the EU SMEs, followed by leasing and hire purchase and trade credit.

There are various factors that affect the external financing available to SMEs in the European Union from both supply and demand side: general economic outlook, firm specific outlook, own capital of firms, credit history, willingness of bank to lend, credit conditions, interest rate level, etc.

In 2015, the majority of EU SMEs registered an improvement in the availability of finance for any of the types of funding, except for debt securities. This evolution is related to the decreased levels of the interest rate but also the positive influence of other factors (credit history, firms' capital, firm-specific outlook, the willingness of banks to lend).

The measures taken at the European and national levels intend to improve the general economic environment and to support the access to finance for SMEs. Thus, the SMEs could benefit from better capitalization and alternative sources can play a useful and complementary role in financing.

## 6. References

- [1] Ayyagari, M., Demirgüç-Kunt, A., Maksimovic, V., "How Important Are Financing Constraints? The Role of Finance in the Business Environment", *World Bank Policy Research*, Working Paper 3820, 2006
- [2] Beck, T., „Financing Constraints of SMEs in Developing Countries: Evidence, Determinants and Solutions”, *World Bank Working Paper*, April 2007
- Berger, A., Udell, G., “A More Complete Conceptual Framework for Financing of Small and Medium Enterprises”, *World Bank Policy Research*, Working Paper 3795, 2005
- [3] European Commission, “Survey on the access

- to finance of enterprises (SAFE)", Analytical Report, Dec. 2015a
- [4] European Commission, „Survey on the access to finance of enterprises in the Euro area, October 2014 to March 2015”, June 2015b
- [5] European Commission, “Small and Medium-Sized Enterprises' Access to Finance,” European Semester Thematic Fiche, 2015c
- [6] European Commission, “COSME Financial Instruments”, 2014
- European Commission, “SMEs' Access to Finance”, November 2013

# The Right to a Fair Trial among the Procedural Rights

Alexandru Marian

*Ovidius University of Constanta, Faculty of Law and Administrative Sciences*  
[marian\\_alexandru\\_ct@yahoo.com](mailto:marian_alexandru_ct@yahoo.com)

## Abstract

*This work wants to make an analysis of the human right to a fair trial in matter of procedural rights. In the centre of our analysis is Article 6 of the European Convention of the Human Rights as it is the one that regulates the right of any person to be fairly and publicly tried within a reasonable time.*

**Key words:** fair trial, right to defense, reasonable time, European Convention of Human Rights

**J.E.L. classification:** K0

## 1. Introduction

When defining the equity principle of the procedure, which contains both the right to defense and the equity of arms, as it is mentioned in art 6, paragraph 1 of the European Convention for Human Rights, the specialized literature [1] stressed that *equity* comes from the latin word *aequus* meaning equal, balanced. Thus, starting with the etymological sense of the fair trial, specified by art 6 of the Convention, we find that it contains a large number of procedural rights proper to any person involved in a trial such as: the right to a public hearing, with final solution given within a time and by a independent and impartial court, the right to be presumed innocent etc. The jurisprudence of Strasbourg Court decided that "after the principle of equity of arms, one of the elements of the extensive notion of a fair trial, each party shall have the reasonable opportunity to present the case in such conditions that will not put her in an inferior position in the relation with its opponent" [2].

## 2. The right to a fair hearing

The right to a fair hearing, regulated by

art 6 [3] of the European Convention, being a procedural guarantee of the rights and freedoms of a person before courts, represents one of the premises which assures a superiority of the right in a democratic society [4].

The article contains [5]:

a) a description of the guarantee mechanism. „Any person has the right (...) to a fair hearing before a court which shall decide”.

The analysis of the focuses both on its object (the guarantee of a fair trial) and on its subjects, whereas the right entitled person can be any person (justice seeker), legal or natural, of any nationality, while the guarantee *debtor* is the State, as signatory member of the European Convention, having jurisdiction over right entitled person.

b) Guarantee enforcing area, „(case hearing) by a court which shall decide either on breaching the civil rights and obligations or on the solidity of any accusation in criminal matter brought against” Thus, the appeals concerning the civil rights and obligations and the criminal accusations in criminal matter belong to the area of enforcing the guarantee of the right to a fair hearing.

c) The general content of the guarantee. Article 6 paragraph 1 of the European Convention states: “entitled to a fair and public hearing within a reasonable time by an independent and impartial tribunal established by law”. This is to enforced both in the criminal and civil matter.

This paragraph stipulates the following guarantees for a fair trial:

- (1) the right to a legal independent and impartial court;
- (2) the right to public hearing;
- (3) the right to be tried within a reasonable time period;
- (4) the right to the principle of equal arms;
- (5) the right to the principle of contradiction;



(6) the defendant right to keep silence not to self incriminate ;

(7) the right to have the court decision motivated.

d) the specific content of the guarantee in criminal matter. Paragraph 2 of art. 6 states the presumption to innocence: „Everyone charged with a criminal offence shall be presumed innocent until proved guilty according to law”.

Paragraph 3 of art 6 contains a series of rights granted to the person against which a criminal accusation is addressed, without being limited:

“Every accused person has the right to be informed promptly in a language which he understands and in details of the nature and cause of the accusation against him; to have adequate time and facilities for the preparation of his defense; to defend himself in person or through legal assistance of his own choosing or, if he has not sufficient means to pay for legal assistance, to be given it free when the interests of justice so require; to examine or have examined witnesses against him and to obtain the attendance and examination of witnesses on his behalf under the same conditions as witnesses against him; to have free assistance of interpreter if he cannot understand or speak the language used in court”.

The analysis of the rights of paragraph 3 art 6 must be done while taking into account that all these rights are part of the general notion of fair trial; for this, the European Court [6] considered that a request based on the provisions of art 6 paragraph 3 must be analyzed also by relating it to the provisions of paragraph 1, given the object and the purpose of art 6, to insure the guarantee of individual freedoms against any arbitrary.

In order to understand the content of the rights protected by this article, it is important to underline the principle contented by art 19 of the European Convention: the activity of the European Court is dedicated to the aim of assuring the observance of the obligations adopted by the signatory states of the European Convention. Thus, The European Court shall not examine *de facto* or *de iure* errors presumed to have been done by national jurisdictions, unless they breach the rights and freedoms defended by the European Convention.

If article 6 guarantees the right to a fair

trial, it is not the case with, for instance, aspects regarding the admissibility of evidence, which are regulated by internal law. Also, in order to enforce article, the aspects regarding the petitioner guilt are not relevant. The European Court shall only analyze if the procedure was just, meaning if the trial observed the conditions of the European Convention.

The European controlling court constantly showed in jurisprudence that the obligations of article 6 assumed by the signatory states are resulting obligations. The states have complete freedom to choose the means that allow the judicial system to reach its goals provided by article 6: free access to justice, celerity, publicity, equity of arm etc [7].

The expression fair trial is defined by art 6 of the European Convention, also stipulated by art 21 paragraph 3 of the Romanian Constitution, by limiting to enumerate the main aspects of the equity, above mentioned, each of them representing a main direction of the criminal trial.

As it has already stressed out [8], the equity leads to „due process of law”. That’s why it involves a strict direction, where equity includes defending rights and equity or arms, but also an extensive way, where equity means good justice, together with judges incompatibility, presumption of innocence and even celerity of procedures, principles of general and individual interest [9].

From this point of view, the right to a fair hearing shouldn’t be considered a director principle of the criminal proceeding, different for other principles, already debated, in spite of the constitutional regulation, it should be present in the content of any procedure, during the entire time of the criminal trial, as a cumulus of procedural guarantees granted to the involved person (accused of defendant).

The specialized literature in the field designates these guarantees while it mentions not only equity and but also *human rights*, more exactly the rights of the involved person, always at stake in the criminal trial.

Or, this means exactly the protective principles of the person that are understood from the content of the article 6 of the European Convention, such as the right superiority principle, the publicity of the debates, the reasonable time, guarantee of the

right to defense and the defense rights equity of arms, observance of the contradiction character, the motivation of the decisions, the presumption of innocence and the accused person's right to keep silent and not to incriminate him. As it was considered [10], they must represent the requests in order to have fair trial and be enforced during its process.

We think it is almost impossible to define the term "fair trial" due to the special special circumstances when it appeared, between the constant elements of the rights and freedoms in contemporary judicial and fundamental systems.

### **3. The evolutions of the procedural guarantees**

The evolutions of the procedural guarantees was first the work of the British and American courts and afterwards the European Court and Commission of the Human Rights added new elements to the already known ones [11]. The absence of a possible definition led to the frequent use of the "fair trial" to designate the entire sum of rights offered to justice seekers by article 6 of the Convention, meaning all the procedural guarantees which allow valuing the rights protected by the Convention [12].

We consider that the right to a fair trial represents all the procedural guarantees accompanying any litigation, no matter the area or matter of the trial and no matter the text of the European Convention that regulates the actual way of enforcement during the trial.

The above stipulated definition is supported also by the fact that the idea of fair trial leads to STAT DE DREPT, whose main and basic feature is elimination of the arbitrary character and the law reign.

These two objectives of any democratic state are equal, offering at the same time more and more extensive guarantees concerning the procedural matter, both by enlarging the word trial in areas that are related to administrative or disciplinary courts, and by limiting as exactly as possible the balance line present between the basic rights and other interests of the states.

### **4. Conclusion**

Thus, reducing the right notion to a fair trial only for the institutions covered by article 6 of the European Convention would be a completely formal reduction lacking a real base, offered only by the necessity of protection of the Right State idea.

We think the judicial character of the right in a fair trial is impossible to be established. Its content is so complex and involves so many obligations for the States that it is impossible to say if a private entitled person, owner of this right, is the beneficiary of a right and freedom, if it is an absolute right or a relative right, if the state obligation is a negative or a positive one or if the obligation imposed to the state is a result obligation or a means one.

Clearly, each of them, the right to a access to justice, the right to a neutral court, the right to a contradictory procedure, the right to judicial assistance and others that make up the extensive notion of right to equity trial can be the object of such discussions, but a general stipulation concerning the entire complex of rights and freedoms that are part of this notion cannot be formulated.

That's why, our opinion is that the Court affirmation, made several times, according to which the obligations stated at art 6 are result obligations and the states have full freedom when choosing the useful means for reaching all the goals mentioned by art 6, is a risky sentence [13].

The right to fair trial cannot be qualified as a result obligation, as long as it means many positive obligations assumed by the State, which by their nature are means obligations.

Even the European Court admitted several times that, for instance, the state obligation to assure the enforcement of the court orders is a means obligation when the obligation debtor set by order is a public right person, therefore we think a general discussion on this aspect is pointless, and we are to analyze, where it is necessary, the judicial character of the guarantees involved by a right in a fair trial.

### **5. References**

- [1] *J. Pradel*, La notion de proces equitable en droit pñal european, „Revue general de droit"

- (Faculte de droit de Ottawa, section de droit civil), 1996, p. 504 and sequel *apud* Gheorghită Mateuț, Criminal Substantial Law, *General View*, Editura C.H. Beck, București, 2011, p. 47.
- [2] European Court of Human Rights, 22<sup>nd</sup> February 1996, *Bulut c. Austriei*, *apud* Gheorghită Mateuț, *op. cit.*, p. 48.
- [3] „1. Any person has the right to fair, public trial within reasonable time for his case, in an independent and impartial legally founded court, which shall order either on the breach of the rights and obligations in civil matter, either on the bases of each accusation in criminal law brought against him. The order must p=be pronounced in a public way, but the access in the court room can be forbidden for the press and public during the entire time of the trial or a part of it in the interest of morality, of public order or national security in a democratic society, when the interest of under aged or the life protection of the parties demands it, or if the measure considered absolutely necessary by the court, in special circumstances, publicity would affect the interests of justice.
2. Any person accused of committing a crime is presumed innocent until his guilt is legally proved.
3. Any accused person has the right: a) to be informed, promptly, in a language he understands and in detail, about the type and character of the accusation brought against him; b) to have the time and the necessary means to prepare his defense; c) to defend himself or to be assisted by lawyer chosen by him, if he has the means, or by an ex office lawyer for free; d) to ask and demand the hearing of the accusation witnesses and to obtain summons for hearing the defense witnesses in the same conditions; e) to have interpreter in the court room if he doesn't understand or speak the language used during the trial.”
- [4] Corneliu Bîrsan, *op. cit.*, p. 393.
- [5] Ovidiu Predescu, Mihail Udriou, *European Convention for Human Rights and the Romanian Criminal Trial*, Publishing House CHBeck, București, 2009, p. 258.
- [6] European Court of Human Rights, Decision of 12<sup>th</sup> Februarye 1985, case: *Colozza/vs/ Italy*, parag. 26-27.
- [7] Radu Chiriță, *European Convention for Human Rights, Comments and explanations, vol. I*, Publishing House C.H.Beck, Bucharest, 2011, p. 237.
- [8] *J. Pradel, Criminal Procedure*, 13<sup>e</sup> edition, 2006/2007, p. 334, *apud* Gheorghită Mateuț, *op. cit.*, p. 48.
- [9] *Ibidem*.
- [10] Corneliu Bîrsan, *op. cit.*, pp. 505-506.
- [11] Radu Chiriță, *op. cit.*, p. 12.
- [12] *European Court of Human Rights*, Decision. *Artico/vs/Italy* of 13<sup>th</sup> May 1980.
- [13] Curtea Europeană a Drepturilor Omului, hotărârea . *Colozza/c/Italia* din 12 februarie 1985.

# The Independence of the Law Court

Alexandru Marian

*Ovidius University of Constanta, Faculty of Law and Administrative Sciences*  
[marian\\_alexandru\\_ct@yahoo.com](mailto:marian_alexandru_ct@yahoo.com)

## Abstract

*This work will analyze which are the conditions in which the judges' power is independent towards the legislative and executive.*

**Key words:** power, independence, judge, Law Court.

**J.E.L. classification:** K0

## 1. Introduction

The independence of a law court is a very difficult notion to be defined in a holistic and extensive way; it means the absence of any subordination of the jurisdictional authority called to find a solution in a litigation, towards the parties and any type of power, either political or other form of pressure; secondly, independence of the law court means that this is the only one to decide in a litigation brought to justice; one cannot discuss about independence when the court is imposed a certain solution imposed, unless it was pronounced by another law court in a contradictory procedure. For instance, the independence obligation was not valid when the president of a law court warned the judging panel about the solution of the litigation previously adopted by a judging inspector and which had to be adopted also by the court of first instance [1].

The basic condition for independence, provided clearly also in the text of the European Convention of the Human Rights, is that the law court should be governed by a sum of rules and regulations provided by the internal law [2].

The condition is observed by all the Convention signatory states, most of them having constitutional provisions that forbid the presence of other law courts founded in way they don't respect the law, so there were no special problems appeared in

jurisprudence, and that is why we will not focus on it anymore.

## 2. The independence of judges

In order to determine whether the Court is independent or not, we should take into account the following elements: the absence of any involvement – or apparent involvement – of other powers of the State or the parties', and also the presence of some real guarantees against some possible external pressures [3].

The independence of the judges – functional or organic – concerns their entire activity. Therefore, it doesn't regard only the public proceedings but also the previous and subsequent activities, such as setting of the trial time or issuing and drawing up the written of the ruled decision [4].

In exchange, there is a unanimity of opinions according to which, given their nature, the authorities involved in the criminal investigation are not governed by the necessity to have their independence guaranteed, as they are part of the executive and cannot be independent towards parties as long as they represent one of the parties – accusation – during the trial step of a criminal proceeding [5].

Thus, functionally, the independence is verified towards other state authorities and towards parties [6].

The independence of the judges towards the legislative power and, especially towards the executive one, is a principle which results from the state powers separation theory developed by Montesquieu and, although it is old, this concept appears in most texts of constitutional character in the European countries as: „judges obey only the law” [7].

The judges' independence towards the legislative means that the law maker cannot interfere with the trial process in other form that the one of issuing laws to be enforced by the judges [8].

For instance, it is clear interference in the right of any person in an independent law court if the Parliament of a country issues a law, with retroactive enforcement, that will interfere with the solution of the litigations in which the State is a part, forcing the judge by law, to promote the solution in his favor.

Yet, the law courts don't have absolute independence towards the law maker, as they cannot refuse the application of a law issued by the latter, by invoking their independence [9].

The term of equity of means, or the fair proceedings, is verified according to the special circumstances of each case, as the matter cannot be strictly classified or defined. We can have other situations where a violation of art 6, as element of the judicial vocabulary, a notion to express the violated right by the state in fault [10].

Regarding the independence towards the executive, the law court verifies, mostly, the existence of some clerks, subordinated, within the court. As only their simple presence is not compatible with its independence [11].

Nevertheless, if one of the court members is subordinated to one of the parties, the justice seekers can doubt of the court independence, which leads to breach of confidence and thus a violation of art 6 [12].

Talking about the activity of some administrative authorities, the court accepts that the lack of independence of such authority can be compensated by control made by an ordinary court, under the imperative condition that it has full jurisdiction on both the real situation and the judicial problems [13].

About the independence towards parties, it is certain that a court cannot be considered independent, and thus, impartial, when one party is also judge, as it happens in many cases in administrative – jurisdictional proceedings.

The conclusion remains valid also when a party has a determining role in the proceedings. For instance, the court denied the conformity of the procedure with the Convention before the British martial courts. Judges were assigned by an officer that had also the role of accuser. More, the same officer could dissolve the court and the enforcement of the order was subjected to his approval, the court discovered that many

times the right to a trial by an independent and impartial law court had been violated [14].

Identically, we cannot talk about an independent court if a doctor, member of a doctors' college, lodged a case before the college. The same way, an court cannot be considered independent towards parties when it demands a party to draw up an expertise report and whose conclusions are decisive for the solution of the litigation [15].

From the organic point of view, the judges; independence is verified according to the way they are assigned and the time of their power. Mainly, their assignment by administrative authorities and a limited power are considered independence elements towards the authority which name them [16].

Yet, it has been decided that there is no dependence clue when part of a law court is made up of unprofessional judges, named for 6 years, by the Parliament when their power cannot be taken back by legislative.

### **3. Further considerations on the independence of judges**

Also, the independence of the judges force States to forbid them to be members of political parties or interest or pressure groups or have in public positions.

At the same time, independence of the judges doesn't exclude the control of their activity – as it would be against the imperative of the independence – to assure an impartial justice. The Convention allows the existence of a jurisdictional control – through invalidation of the decision of the superior law court – or disciplinary control – by sanctions for lack of punctuality and improper attitude etc.

On the criminal right in our country, there is no doubt that that independence of the law courts [17] (institutional independence) and the independence the judges (personal independence) are basic conditions for the existence of the constitutional state and for a basic guarantee of a fair trial.

Law courts are independent from the executive, the minister or the legislative.

According to art 124 paragraph 3 of the Constitution and art 2 paragraph 2 of the Law no 303/2004 on the statute of judges and prosecutors [18], judges are independent and are obey only the law.

Permanently named judges [19] are named by presidential order enjoy immovability [20]. Thus, immovable judges can be transferred, by order, delegation or promotion only if they approve it. They can be suspended or fired only within the strict limits of the law Chapter VI of Law 30.3/2004.

Any type of decision involving the selection, recruitment, assignment, promotion or firing a judge belongs to the C.S.M, that guarantees the justice independence [21]. The Superior Magistrate Council is independent and obeys only the law.

To guarantee the independence of the judges, Law no 303/2004 set a series of interdictions and incompatibilities.

Thus, a judge position is not compatible with any other public or private functions, except for the teaching activity in the high studies system and within the National Institute of Judges and the National School of Judicial Clerks.

Judges are not allowed to be operative workers, under cover, informers or collaborators of secret services. They cannot be part of political parties nor carry out or participate to political activities. At the same time, judges have the obligation to express their political opinions while carrying out their activity.

#### 4. Conclusion

Judges have the obligation to make each year a statement in which they have to write if their spouse, relatives of friends (up to 4<sup>th</sup> degree) have a position or carry out a judicial activity or research or criminal investigating activities, including mentioning their working places.

Thus, we can see that the internal regulation assures, *de iure*, the independence of the institution of judges towards the executive, towards Public Minister, the legislative or the parties in a case.

#### 5. References

[1] European Court of Human Rights, decision Hirschhorn/c/Romania of 26<sup>th</sup> July 2009.  
[2] F. Tulkens, H. D. Bosly, *La notion europeenne de tribunal independant et impartial. La situation en Belgique*, in RSC, 1990, p. 680.

[3] European Court of Human Rights, decision Campbell and Fell/c/Grat Britain of 28<sup>th</sup> June 1984. We must mention that this decision brings evolution for the previous decision of the Court. If the decision with Le Compte and other/c./Belgium we have independence only towards executive and parties, the decision in case Campbell and Fell the Court mentions that the independence must be checked especially in relation with the executive and parties.  
[4] T. Weigend, *La notion de tribunal impartial et independant en Republique federale d'Allemagne*, in RSC, 1990, p. 744.  
[5] J. Robert, *Droits de l'homme et libertesfondamentals*, Publishing House Montchrestien, Paris, 1996, p. 271.  
[6] A special situation of independence towards parties appears in the case of arbitrary courts, their independence being, according to the Commission, as long as the members even though part of them are assigned by each party of the litigation.  
[7] J. Figueiredo Dias, M. J., Antunes, *La notion europeenne de tribunal independant et impartial. Une approche a partir du droit portugais de procedure penale*, in RSC 1990, p. 734.  
[8] Commission, decision of 18<sup>th</sup> December 1980, plg. nr. 8603/79, in DR nr. 22, p. 147.  
[9] The only exception could be, in certain national systems, the refusal to apply a law contrary to some constitutional decision. T. Weigend, *op. cit.*, p. 746.  
[10] For instance, there have been debates on the breaching the right to a fair trial, when the judge misled the defendant on the content of the accusations against him (Commission, report Colak/c./Germany of 6<sup>th</sup> October 1987, in DR nr. 34, p. 138).  
[11] European Court of Human Rights decision Ringeisen/c/Austria of 13<sup>th</sup> October 1974. Yet the presence of some professional judges, within the law courts is a sign of independence.  
[12] Radu Chiriță, *op. cit.*, p. 40.  
[13] European Court of Human Rights, decision, Tsfayo/c/Great Britain of 14<sup>th</sup> November 2011.  
[14] European Court of Human Rights, decision Findlay/c./ Great Britain of 25<sup>th</sup> February 2009.  
[15] European Court of Human Rights, decision, Sara Lind Eggertdottir/c/Island of 5 July 2010.  
[16] These elements remain simple elements, verification should continue.  
[17] For a detailed analysis: Corneliu Turianu, *Basic principles of judges independence and guaranteeing and enforcing the human*

*fundamental rights and freedoms*, Law no 4/2006, pp. 191-201; I. Popa, *Treaty on being a judge in România*, Publishing House Universul Juridic, Bucharest, 2007, pp. 181-199; Transparency International Romania, Study on the perception of judges on the judicial system independence, 2006, [www.transparency.org.ro](http://www.transparency.org.ro); C. Alexe, The need to protect the Romanian judge towards the justice obstruction, in *Pandectele române* no. 3 /2009, pp. 215-236.

[18] Official Monitor no. 826 of 13<sup>th</sup> September 2005.

[19] Probation judges are named after graduating the Judges National Institute by CSM.

[20] See P. Florea, *Principles governing the justice*, on [www.scj.ro](http://www.scj.ro).

[21] See the monitoring report of C.S.M. about justice independence (January-April 2007), issue by Sojust, on [www.sojust.ro](http://www.sojust.ro).

